

Indoor Unit Operation & Installation Manual

AWSI-HAV007-N11

AWSI-HAV009-N11

AWSI-HAV012-N11

AWSI-HAV018-N11

AWSI-HAV024-N11

No.0150510087

- Please read this manual carefully before using
- Keep this operation manual for future reference

User Manual

Your air conditioner may be subject to any change owing to the improvement of Airwell products.

Flow Logic II series multiple air conditioner systems adopt the consistent running mode, by which, all indoor units can only be heating or refrigerating operation at the same time.

To protect the compressor, the air conditioner unit should be powered on for over 12 hours before using it.

All indoor units of the same refrigerating system should use the unified power switch to ensure that all indoor units are in the state of being powered on at the same time during the operation of air conditioner.

Product Features

1. Hanging-style installation to save space;
2. Automatic display of faults;
3. Function of central control (optional from our company).
4. The air conditioner is provided with the function of compensation for power supply. During operation, when the power supply fails emergently and resumes again, the air conditioner returns to the working condition before power failure, if provided with compensation function.
5. The operating methods and functions are same although the shapes of indoor units are different. Therefore, the outline drawing of HAV007 indoor unit is taken as an example for illustration.
6. This indoor unit only has remote controller function.

Contents

Parts and Functions	1-3
Safety Considerations	4-6
Operation instruction	7-10
Emergency Running & Test operation	11
Maintenance	12-13
Fault Checkup	14
Installation Procedures	15-18
Electrical Wiring	19-23
Test Run & Fault Code	24-25
Disposal	26

whole model	brief model
AWSI-HAV007-N11	HAV007
AWSI-HAV009-N11	HAV009
AWSI-HAV012-N11	HAV012
AWSI-HAV018-N11	HAV018
AWSI-HAV024-N11	HAV024

The brief model is used in this manual for above models.

Operating Range of Air Conditioner

cooling dry	indoor	max.	DB: 32°C	WB: 23°C
		min.	DB: 18°C	WB: 14°C
	outdoor	max.	DB: 43°C	WB: 26°C
		min.	DB: -5°C	
heating	indoor	max.	DB: 27°C	
		min.	DB: 15°C	
	outdoor	max.	DB: 21°C	WB: 15.5°C
		min.	DB: -15°C	

Parts and Functions

Indoor Unit

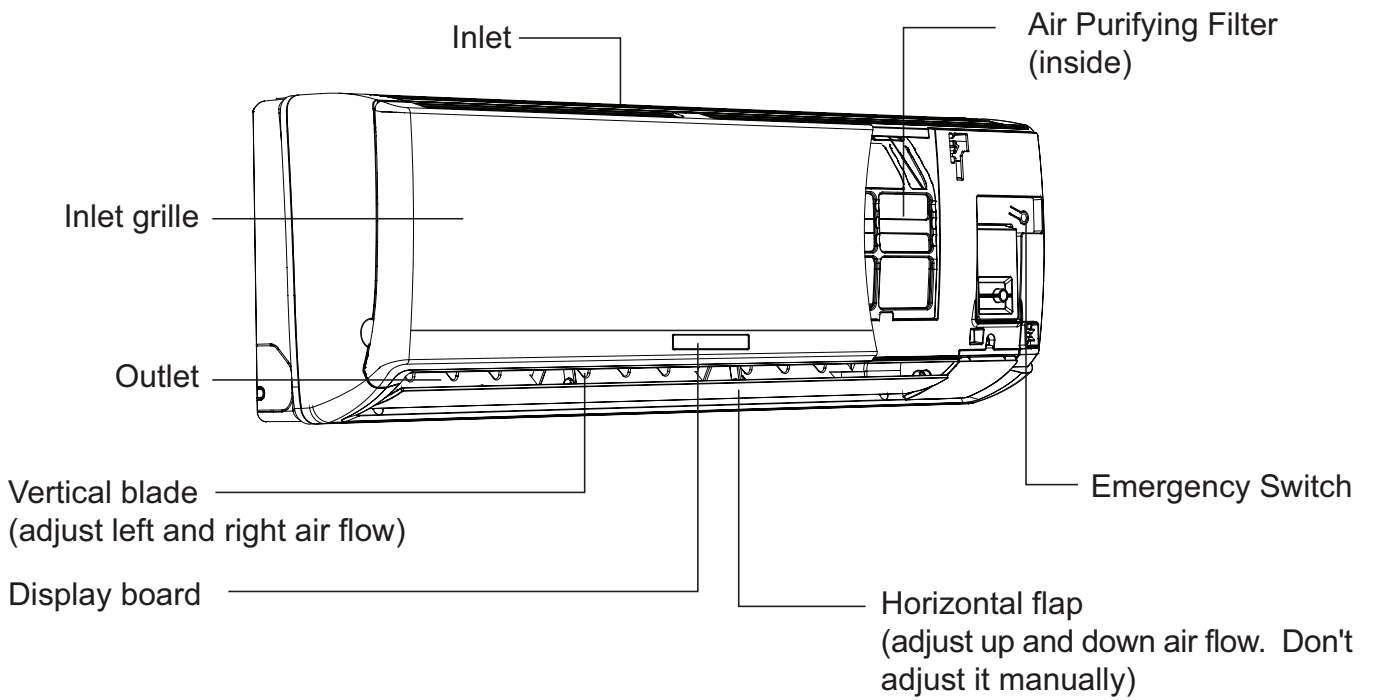

Parts and Functions

Remote controller

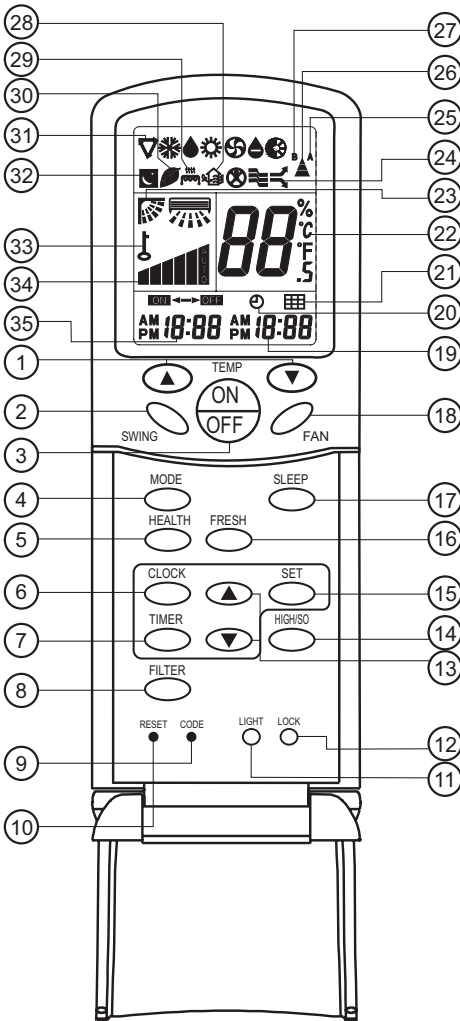

1.TEMP Setting Button

Used to set temperature.

The temperature ranges: 16°C~ 30°C.

In Up/Down function of filter, for controlling up and down filter.

2.SWING Button

If you press this button once, auto swing will be activated.

If you press this button again, the louver will fix in the present position.

3.Power ON/OFF Button

Used for unit to start or stop.

After power on, the LCD of remote controller will display the previous operation state (except for TIMER,SLEEP and SWING state).

4.Operation MODE Button

Used to select operation mode.

Every time you press MODE button, operation mode changes according to following sequence:



5.HEALTH Button

Used to set health operation function.

6.CLOCK Button

Used to set correct time.

7.TIMER Button

Used to select TIMER mode:TIMER ON,TIMER OFF, TIMER ON-OFF.

(Note: if the time of TIMER ON is the same as TIMER OFF, TIMER ON-OFF cannot be set)

8. FILTER Button

Used to set up/down function of filter.

9.CODE Button

Used to select Code A or B, Normally at Code A. As you can't control the indoor unit, please change the Code to B.

10.RESET Button

Press this button by using a sharp article to resume the correct operation of the remote controller in case of need, for example, in case of malfunctions due to electromagnetic disturbance.

11.LIGHT Button

Used to light the control panel

12.LOCK Button

Used to lock operation button and LCD display contents. If you press this button, the other buttons come out of function and lock state display appears; if you press it again, lock state will be no more active and lock state display will disappear.

13.HOUR Adjustment Button

Used to set clock and timer setting

14.HIGH/SO Button

Used to select HIGH or SOFT operation.

15.SET Button

Used to confirm TIMER and CLOCK settings.

16.FRESH Button

Used to set fresh mode, the unit will draw in fresh air.

17.SLEEP Button

Used to set sleep mode. (The clock must be corrected before setting sleep function)

18.FAN Button

Used to select fan speed:LOW,MID,HIGH,AUTO.

19.TIME Display

20.TIMER Display

21.FILTER Display

When the filter need be cleaned, you can press the FILTER button for 3s, to up/down function.

22.TEMPERATURE Display

23.AUTO SWING Display

Parts and Functions

24.HIGN/SO Run Display

25.Code A of controller's state

Code A is used for the units in this manual.

26.SIGNAL SENDING Display

27.Code B of controller's state

28.Fresh Display

29.Auxiliary ELECTRICAL HEATING Display

30.HEALTH Display

Displays when healthy run function is set.

31.Operation MODE Display

AUTO RUN	COOL RUN	DRY RUN	HEAT RUN	FAN RUN
▽	☼	💧	☀	⊕

32.SLEEP State Display

33.LOCK State Display

34.FAN SPEED Display



35.TIMER ON Display

Note:

1.Models in this manual have no functions

⑤ ⑧ ⑪ ⑭ ⑯ ⑰ ⑲ ⑳ ㉓ ㉔ ㉖ ㉗ ㉙ ㉚

2.HIGH/SO button

This button is active in Cooling/Heating mode, the fan speed is in AUTO mode after pressing it and "high function" will be automatically cancelled after 15 minutes running.

Remote Controller Operation

- When in use, direct signal transmission head to the receiver placed on the indoor unit.
- The distance between the remote controller and the receiver should be max 7m and there should be no obstacle between them.
- Do not throw the remote controller to prevent it from being damaged.

Clock Set

When the unit is started for the first time or after replacing batteries in remote controller, clock should be adjusted as follows:

- 1.Press CLOCK button, clock indication of " AM " or " PM " flashes.
- 2.Press " ▲ " or " ▼ " to set correct time. Each press the time will increase or decrease by 1 min. If the button is kept pressed, the time will increase or decrease quickly.
- 3.Press "SET" button to confirm the time setting. AM or PM stop flashing, while clock starts working.

Note:AM means morning and PM means afternoon.

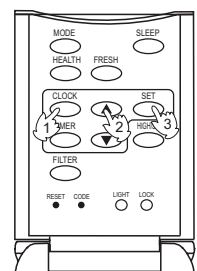

- When operating the remote controller in an area where electronically controlled lights are installed or wireless handsets are used, please move closer to the indoor unit as the function of the remote controller might be affected by signals emitted by the above mentioned equipments.

Battery loading

Batteries are fitted as follows:

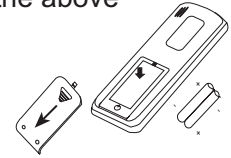

Remove the battery compartment lid

Slightly press and disengage the battery compartment lid marked with " ▽ " and then hold the remote controller by the upper section and then remove the battery compartment lid by pressing in the direction of the arrow as shown in the figure above.

Loading the battery

Ensure that batteries are correctly placed in the compartment as required for positive and negative terminals.

Replacing the battery compartment lid

The battery compartment lid is reinstalled in the reverse sequence.

Display review

Press the button to see if batteries are properly fitted. If no display appears, refit the batteries.

Confirming indicator

If no indication is displayed after press ON/OFF button, reload the batteries.

Caution: if the remote controller does not operate as designed after fitting new batteries of the same type, press the Reset button (marked ↓) with a pointed article.

Note:

It is recommended that the batteries should be removed from the compartment if the remote controller is not used for an extended period.

The remote controller is programmed for automatic test of operation mode after the batteries are replaced. When the test is conducted, all icons will appear on the screen and then disappear if the batteries are properly fitted. When throw away the waste batteries, please perform in accordance with the local regulation.

Safety Considerations

- If the air conditioner is transferred to a new user, this manual shall be transferred to the user, together with the conditioner.
- Before installation, be sure to read Safety Considerations in this manual for proper installation.
- The safety considerations stated below is divided into “⚠ Warning” and “⚠ Attention”. The matters on severe accidents caused from wrong installation, which is likely to lead to death or serious injury, are listed in “⚠ Warning”. However, the matters listed in “⚠ Attention” are also likely cause the severe accidents. In general, both of them are the important items related to the security, which should be strictly abided by.
- After the installation, perform test run to make sure everything is in normal conditions, and then operate and maintain the air conditioner in accordance with the User Manual. The User Manual should be delivered to the user for proper keeping.

Warning

- Please ask the special maintenance station for installation and repair. Water leakage, electric shocks or fire accidents might be caused from improper installation if you conduct the installation by your own.
- The installation should be conducted properly according to this manual. Water leakage, electric shocks or fire accidents might be caused from improper installation.
Please make sure to install the air conditioner on the place where can bear the weight of the air conditioner.
- The air conditioner can't be installed on the grids such as the non-special metal burglar-proof net. The place with insufficient support strength might cause the dropdown of the machine, which may lead to personal injuries.
- The installation should be ensured against typhoons and earthquakes, etc. The installation unconformable to the requirements will lead to accidents due to the turnover of the machine.
- Specific cables should be used for reliable connections of the wirings. Please fix the terminal connections reliably to avoid the outside force applied on the cables from being impressed on the cables. Improper connections and fixings might lead to such accidents as heating or fire accidents.
- Correct shapes of wirings should be kept while the embossed shape is not allowed. The wirings should be reliably connected to avoid the cover and the plate of the electrical cabinet lipping the wiring. Improper installation might cause such accidents as heating or fire accidents.
- While placing or reinstalling the air conditioner, except the specific refrigerant (R410A), don't let the air go into the refrigeration cycle system. The air in the refrigeration cycle system might lead to the cracking or personal injuries due to abnormal high pressure of the refrigeration cycle system.
- During installation, please use the accompanied spare parts or specific parts. If not, water leakage, electric shocks, fire accidents or refrigerant leakage might be caused.
- Don't drain the water from the drainpipe to the waterspout where may exist harmful gases such as sulfureted gas to avoid the harmful gases entering into the room.
- During installation, if refrigerant leakage occurs, ventilation measures should be taken, for the refrigerant gas might generate harmful gases upon contacting the flame.
- After installation, check if any refrigerant leakage exists. If the refrigerant gas leaks in the room, such things as air blowing heaters and stoves, etc. may generate harmful gases.
- Don't install the air conditioner at the places where the flammable gases may leak. In case the gas leakage occurs around the machine, such accidents as fire disasters may be caused.
- The drainpipe should be properly mounted according to this manual as to ensure the smooth drainage. In addition, heat preservation should be taken to avoid condensation. Improper drainpipe mounting might cause water leakage, which will get the articles at home wet.
- The refrigerant gas pipe and liquid pipe should be heat insulated to preserve heat. For inappropriate heat insulation, the water caused from the condensation will drop to get the article at home wet.

Attention

- The air conditioner should be effectively grounded. Electric shocks may occur if the air conditioner is ungrounded or inappropriately grounded. The wire for earthing shouldn't be connected to the connections on the gas pipe, water pipe, lightning rod or telephone.
- The breaker for electricity leakage should be mounted. If not, accidents such as electric shocks may happen.
- The installed air conditioner should be checked for electricity leakage by being powered.
- If the ambient humidity bigger than 80%, when the water discharge hole be blocked or the filter becomes dirty, or airflow speed change, there maybe leads to condensing water drop down, and at the same time there maybe some drops of water spit out.

Safety Considerations

	<p>Items with this warning sign concerning the product's safety and the personal security must be performed strictly.</p>
	<p>Items with this forbidding sign refer to absolutely forbidden behaviors. If not, they may cause machine damage or endanger operator's personal safety.</p>

Clean the filter regularly.
Cooling or heating performance will be degraded if the filter is blocked, resulting in large power consumption, failure, and water dripping at freezing.

Don't touch the outlet while the flap is moving. Don't put anything in the grid in case danger may occur.

Avoid cold wind from blowing out.
During heating running, the fan of indoor units will not rotate immediately as to prevent cold wind from blowing out.

Changing Wind Speeds:
In the state of refrigerating, with automatic blowing mode, the wind speed automatically decreases when the room temperature approaches the setting.
In the state of heating, when the room temperature reaches the setting temperature the compressor stops working and the fan turns to low wind or stops. Wind speed changes automatically in the dehumidifying mode.

Regulating Wind Direction:
It is recommended not to make the wind deflector downwards for a long time to avoid condensation at air outlet port during refrigerating or dehumidifying.
Water dropping might appear at the air outlet port in refrigerating or dehumidifying mode.

Defrosting:
During heating running, the air conditioner would defrost automatically if there is frost on heat exchanger of outdoor units.
Do not rotate fans of both indoor units and outdoor units during defrosting.
After finishing defrosting, the air conditioner will resume running automatically.

The machine operation must be controlled by the control.









Hints:
As air conditioners absorb heat from the environment and release it to the room, heating effects will be influenced by the temperature in and out of the room.







Safety Considerations



Attention

Notices during Operation

- It is not allowed to put any heating apparatus under the indoor units, for the heat may cause distortion of the units.
- Pay attention to the aeration condition to avoid anoxic symptom.  
- Flammable apparatus should not be placed in the place where the air conditioner wind could reach directly, or incomplete burning of the apparatus may be caused.  
- Check the mount table of the air conditioner for damage for a long period of operation. If placed on the damaged table, the unit may drop down causing damage. 
- Plants and animals should not be put to the place where wind of the air conditioner blows directly, otherwise damage to them may be caused. 
- It cannot be used for the preservation of food, living creature, precise instrument and artworks, etc, otherwise damage may occur. 
- Use the fuse with proper capacity. Metal wires and copper wires, etc., may cause fire or other faults. 
- Do not use water heater or like next to the indoor unit and the wired controller. Water/power leakage or short circuit may happen if the steam generating apparatus is working next to machine. 
- Defrosting during heating
To improve the heating effect, the outdoor unit will perform defrosting automatically when frost appears on the outdoor unit during heating (approximately 2-10 min). During defrosting, the fan of the indoor unit runs at a low speed or stops while that of the outdoor unit stops running.
- Power should be cut off when the air conditioner is left unused for a long period. Power will be consumed if the air conditioner is not powered off. The power switch of the outdoor unit switch should be powered on 12 hours in advance before operation to protect the unit after a long period of storage.

- 3-minute protection
To protect the unit, compressor can be actuated with at least 3-minute delay after stopping.
- Close the window to avoid outdoor air getting in. Curtains or window shutters can be put down to avoid the sunshine. 
- Do not touch the switch with the wet hand to avoid power shock. 
- Stop running and switch off the manual power switch when cleaning the unit. 
- During the operation of the control unit, don't switch off the manual power switch and the controller can be used. Please do not press the liquid crystal zone of controller to prevent damage. 
- Cleaning the unit with water may cause electric shock.  
- Do not put flammable spray close to the air conditioner. Don't inject flammable spray towards the air conditioner, which may cause fire. 
- Stopping fan rotation
The unit which stops operating will actuate the fan for a 2-8 min swing every 30-60 minutes for protecting the unit while other indoor unit are in the operating state.
- This appliance is not intended for use by persons (including children) with reduced physical, sensory or mental capabilities, or lack of experience and knowledge, unless they have been given supervision or instruction concerning use of the appliance by a person responsible for their safety.
- Children should be supervised to ensure that they do not play with the appliance.

Operation instruction

AUTO, COOL , HEAT and DRY Operation

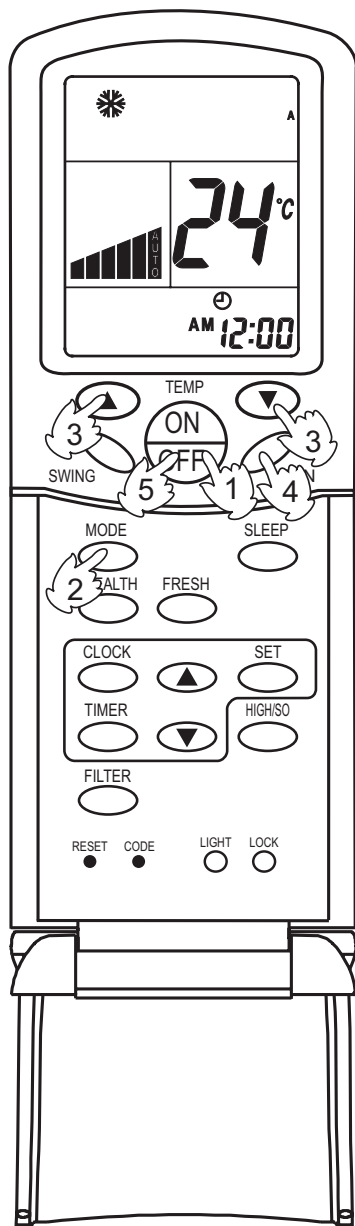

(1) Unit start

Press ON/OFF button, the unit starts.

Previous operation status appears on LCD (except for TIMER, SLEEP and SWING setting)

(2) Select operation mode

Press MODE button. Each press, the operation mode changes as follows:

Code A



Then select AUTO, COOL, DRY or HEAT as needed.

(3) Temperature setting

Press TEMP button.

▲ Every time the button is pressed, the setting temperature increases by 1°C; if the button is kept pressed, the setting temperature will increase quickly.

▼ Every time the button is pressed, the setting temperature decreases by 1°C, if the button is kept pressed, the setting temperature will decrease quickly.

Set the proper temperature.

(4) Adjust fan speed

Press FAN button. Each press, the fan speed changes as follows:

Code A



Air conditioner will run at the selected fan speed.

(5) Unit stop

Press ON/OFF button, the unit stops.

NOTE:

- In FAN mode, the temperature setting is not displayed on LCD.
- In DRY mode, when room temperature becomes 2°C higher than temperature setting, unit will run intermittently at LOW speed regardless of FAN setting. When room temperature is lower than temperature setting, unit will only run FAN operation.
- In HEAT mode, warm air will blow out after a short period of time due to cold-draft prevention function.

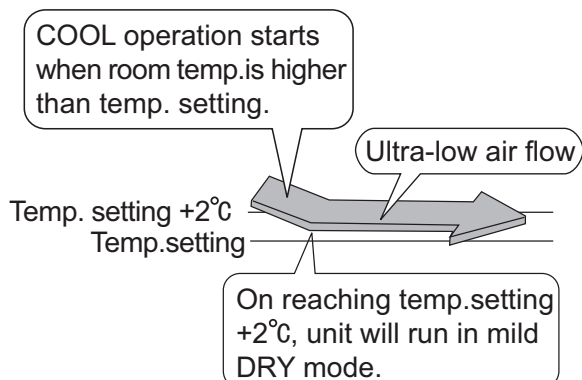

Operation instruction

Fan Operation (Only for Code A)

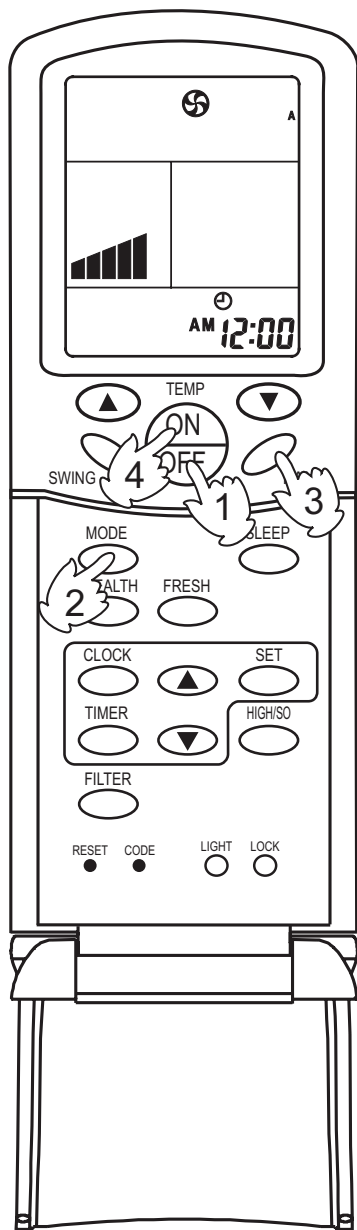

(1) Unit start

Press ON/OFF button to start your air conditioner. Previous operation status appears on LCD (except for TIMER, SLEEP, and SWING setting).

(2) Select operation mode

Press MODE button. Each press, the operation mode changes as follows:



Then select FAN mode.

(3) Adjust fan speed

Press FAN button. Each press, the fan speed changes as follows:



Air conditioner will run at the selected fan speed. When in AUTO mode, the unit will adjust fan speed according to room temperature automatically.

(4) Unit stop

Press ON/OFF button to stop unit.

About FAN mode

When the air conditioner runs in FAN mode, it is not possible to select AUTO FAN or to set temperature.

Operation instruction

Adjusting Air Flow Directon

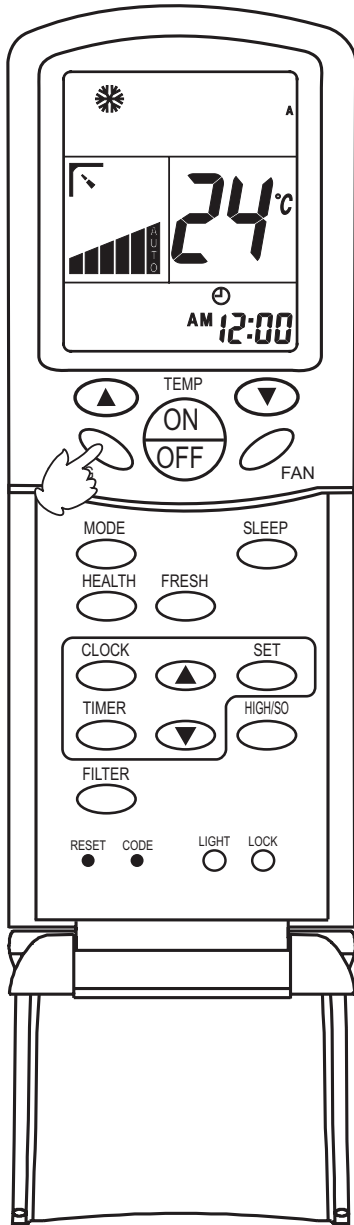

Adjusting air flow direction

Press SWING button.

Up and down airflow varies upwards and downwards.
Left and right airflow varies left and right sides.

When the automatic swing louver moves to the proper angle, press SWING button to fix the airflow direction.

After unit stops:

Displays on the LCD disappear.

All indicators on the indoor unit go out.

Swing louver automatically close the air outlet.

Warning

- Always use SWING button on the remote controller to adjust flaps. Adjusting them by hand may result in air conditioner's abnormally running.
If the louver work abnormally, stop unit, restart and adjust the louver by remote controller.
- In COOL or DRY mode, do not leave the louver in downward position for a long time, as the water vapor close to the grille may condense and water may drop from the air conditioner.
- Please carefully set temperature when children, old or infirm people use the air conditioner.
- In case of great humidity, if the vertical flaps are completely turned towards left or right, the louver will drop water.

Hints:

- As in COOL mode air flows downwards, adjusting airflow horizontally will be much more helpful for a better air circulation
- As in HEAT mode air flows upwards, adjusting airflow downward will be much more helpful for a better air circulation.
- Be careful not to catch a cold when cold air blows downward directly.

Operation instruction

Timer ON/OFF Function

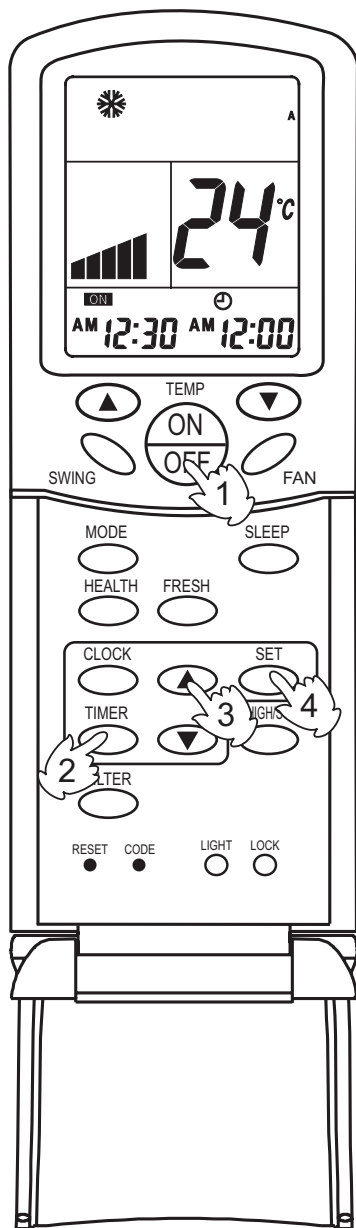

Set clock correctly before starting TIMER operation.

(1) Unit start

After unit start, select your desired operation mode (operation mode will be displayed on LCD).

(2) TIMER mode selection

Press TIMER button on the remote controller to change TIMER mode. Every time the button is pressed, display of TIMER mode changes as follows:



Then select TIMER mode as needed (TIMER ON or TIMER OFF). Now **ON** or **OFF** will flash.

(3) TIMER setting

Press time adjustment buttons ▲

- ▲ Every time the button is pressed, the time increases by 10 minutes.
- ▼ Every time the button is pressed, the time decreases by 10 minutes.

If the button is kept pressed, the time will change quickly.

It can be adjusted within 24 hours at will.

(4) Confirm setting

After setting correct time, press SET button to confirm time. Now **ON** or **OFF** stop flashing.

Time displayed: unit starts or stops at X hour X min (TIMER ON or TIMER OFF)

(5) Cancel TIMER mode

Just press TIMER button several times until TIMER mode disappears.

Hints:

- After replacing batteries or if a power failure occurs, TIMER setting must be reset.
- Remote controller has memory function. When you use TIMER mode next time, just press SET button after mode selection if timer setting is the same as the previous one.

Emergency Running & Test operation

Emergency Running & Test operation:

- Emergency running will help air conditioner operate automatically if your remote control is missing or out of work.
- Test operation is recommended when room temperature is below 16°C but not in normal condition.

Emergency Running

It is recommended to use only when the remote control is missing or damaged.

■ Startup

A warning tone could be heard after turning on the Emergency Running switch, which means that the emergency running gets started.

- Air conditioner operates automatically according to the working modes blow:

Room Temp	Set Temp	Timing Mode	Wind Speed	Working Mode
Over 23°C	26°C	none	auto	cooling
Below 23°C	23°C	none	auto	heating

Temperature setting values and wind speed cannot be changed in the mode of emergency running. Meanwhile, dehumidification and timing operation cannot be operated simultaneously.

■ Shutdown (canceling the emergency running)

All the indicator lamps on the conditioner extinguish after pressing the emergency running switch and hearing the warning tone.

■ Canceling the emergency running with the remote controller

A warning tone is heard after pressing the ON/OFF button on remote controller. The air conditioner works according to the indication of operating state on the remote controller.

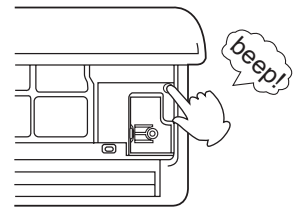

Test Operation

It is recommended when the room temperature is below 16°C but not in normal condition.

■ Startup

Press it for over 5 seconds till 2 warning tones are heard and then release your finger to start the test operation. The air conditioner is operating at high wind speed. The test operation lasts for 30 minutes before the air conditioner stops automatically.

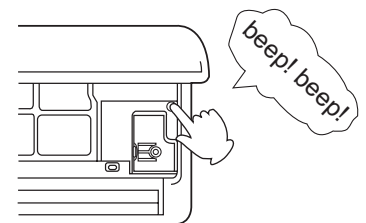

■ Shutdown (canceling the test operation)

The warning tones are followed after pressing the test operation switch.

■ Canceling the test operation with the remote controller

The warning tone could be heard after pressing the switch on remote controller.

The air conditioner works according to the indication of operating state on the remote controller.

Maintenance

※Only when the air cleaner is switched off and disconnected to the power supply can it be cleaned, or electric shock and injury may appear.

Cleaning the air outlet port and the shell:

⚠ Attention

- Don't use gasoline, benzene, diluents, polishing powder or liquid insecticide to clean them.
- Do not clean them with hot water of above 50°C to avoid fading or distorting.
- Wipe them with soft dry cloth.
- Water or neutral dry cleanser is recommended if the dust cannot be removed.
- The Wind Deflector can be dismantled to clean (as below).

Cleaning Wind Deflector:

- Do not wipe the wind deflector with water forcibly to avoid falling off.

Cleaning Air Cleaner:

⚠ Attention

- Don't rinse the air cleaner with hot water of above 50°C to avoid fading and distorting.
- Don't put the air cleaner on the fire to dry to avoid catching fire.

- Wipe dust with water or dust collector.

(A) Wipe dust with dust collector.



(B) Clean it with soft brush in mild detergent if there is too much dust on it

Throw off the water and airing it in the cool dry condition.



Maintenance before and after Operating Season

Before Operating Season:

1. Please make the following checkup. If abnormal condition occurs, consult the after-service personnel.
 - There is no blockage in inlet port and outlet port of outdoor and indoor units.
 - The ground line and the wiring are in the proper state
2. After cleaning, the air cleaner must be mounted.
3. Switch on to the power.

After Operating Season:

1. In sunny days, blowing operation can be performed for half a day to make the inside of machine dry.
2. Electrical power should be cut down to economize electricity, or the machine will still consume power. Air cleaner and shell must be mounted after cleaning.

Maintenance

Clean the machine (Cleaning ways are approximately same, taking HAV018 indoor machine as example).

Turn off the air conditioner before cleaning. Do not touch the machine if the hands are wet. Neither hot water nor solvent should be used in cleaning.

Replacement of Air Purifying Filter

1. Open the Inlet Grille

Prop up the inlet grille by using a small device named grille-support which located in the right side of the indoor unit.

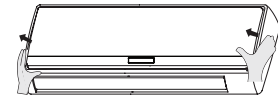

2. Detach the standard air filter

Slide the knob slightly upward to release the filter, then withdraw it.

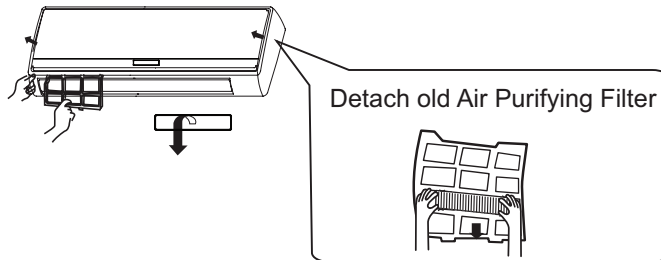

3. Attach Air Purifying Filter

Put air purifying filter appliances into the right and left filter frames.

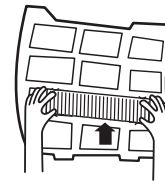

4. Attach the standard air filter (Necessary installation)

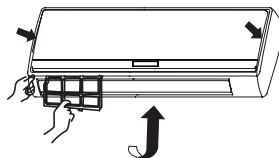

ATTENTION:

The white side of the photocatalyst air purifying filter face outside, and the black side face the unit. The green side of the bacteria-killing medium air purifying filter face outside, and the white side face the unit.

5. Close the Inlet Grille

Close the Grille surely

NOTE:

- The photocatalyst air purifying filter will be solarized in fixed time. In normal family, it will be solarized every 6 months.
- The bacteria-killing medium air purifying filter will be used for a long time, no need for replacement. But in the period of using them, you should remove the dust frequently by using vacuum cleaner or flapping them lightly, otherwise, its performance will be affected.
- Please keep the bacteria-killing medium air purifying filter in the cool and dry conditions, avoid long time directly sunshine when you stop using it, or its ability of sterilization will be reduced.

Fault Checkup

Please check the following when consigning repair service:

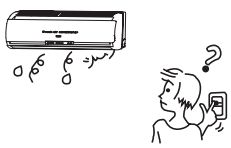
	Symptoms	Reasons
All these are not problems	<ul style="list-style-type: none"> • Water flow sound 	Water flow sound can be heard when starting operation, during operation or immediately after stopping operation. When it starts to work for 2-3 minutes, the sound may become louder, which is the flowing sound of refrigerant or the draining sound of condensed water.
	<ul style="list-style-type: none"> • Cracking sound 	During operation, the air conditioner may make the cracking sound, which is caused from the temperature changes or the slight dilation of heat exchanger.
	<ul style="list-style-type: none"> • Terrible smell in outlet air 	The terrible smell, caused from walls, carpet, furniture, clothing, cigarette and cosmetics, attaches on the conditioner.
	<ul style="list-style-type: none"> • Flashing operating indicator 	When switching it on again after power failure, turn on the manual power switch and the operating indicator flashes.
	<ul style="list-style-type: none"> • Awaiting indication 	It displays the awaiting indication as it fails to perform refrigerating operation while other indoor units are in heating operation. When the operator set it to the refrigerating or heating mode and the operation is opposite to the setting, it displays the awaiting indication.
	<ul style="list-style-type: none"> • Sound in shutdown indoor unit or white steam or cold air 	To prevent oil and refrigerant from blocking the shutdown indoor units, refrigerant flows in the short time and make the sounds of refrigerant flowing. Otherwise, when other indoor units performs heating operation, white steam may occur; during refrigerating operation, cold air may appear.
	<ul style="list-style-type: none"> • Clicking sound when switching the air condition on 	When the conditioner is powered on, the sound is made due to the resetting of the expansion valve.
Please make another check.	<ul style="list-style-type: none"> • Start or stop working automatically 	Check if it is in the state of Timer-ON and Timer-OFF.
	<ul style="list-style-type: none"> • Failure to work 	Check if there is a power failure. Check if the manual power switch is turned off. Check if the supply fuse and breaker are disconnected. Check if the protective unit is working. Check if refrigerating and heating functions are selected simultaneously with the awaiting indication on line control.
	<ul style="list-style-type: none"> • Bad cooling & heating effects 	Check if air intake port and air outlet port of outdoor units are blocked. Check if the door and windows are open. Check if the filtering screen of air cleaner is blocked with sludge or dust. Check if the setting of wind quantity is at low wind. Check if the setting of operation is at the Fan Operation state. Check if the temperature setting is proper.

Under the following circumstances, immediately stop the operation, disconnect the manual supply switch and contact the after-service personnel.

- When buttons are inflexible actuated;
- When fuse and breaker have been burnt over and over;
- When there are foreign objects and water in the refrigerator;
- When it cannot still be operated after removing the operation of protective unit;
- When other abnormal conditions occur.

Installation Procedures

This manual cannot completely illustrate all the properties of the products you bought. Please contact the local Airwell distribution center if you have any question or request.

Please use the standard tool according to the installation requirements.

The standard attached accessories of the units of this series refer to the packing; prepare other accessories according to the requirements of the local installation point of our company.

1. Choose the suitable installation location. Indoor units should be installed in places with the environment of even circulation of cool and warm blows. The following places should be avoided.

※ Places with high salinity (beach), high sulfured gas (such as the thermal spring regions where copper tubes and soft soldering are easy to be eroded), much oil (including mechanical oil) and steam; places where organic substance solvent is frequently used; places where machines generate the high frequency electromagnetic wave (abnormal condition will appear in the control system); places where there is high humidity exists near the door or windows (dew is easily formed); places where the special sprayer is frequently used; and place where high humidity or splash water will occur, such as laundry.

Indoor Units

(1) Indoor unit must be used inside of room, not outdoor side, or some places with high humidity, like laundry.

(2) The distance between wind outlet port and the ground should not be more than 2.7m. The installed height of indoor unit should be between 2~2.7m.

(3) Select appropriate places for installation where the outlet air can be spread to places all over the house and arrange proper locations for connecting pipes and lines as well as the drainpipe to the outdoor.

(4) Ceiling construction must be hard enough to hold the weight of the unit.

(5) Make sure that the connecting pipe, drainpipe and connecting guide line can be put into walls to connect the outdoor units.

(6) It is recommended to make the connecting pipe between the outdoor and indoor units and the drainpipe are as short as possible.

(7) Please read the attached installation instruction of outdoor units for regulation of filling amount of refrigerant if necessary.

(8) Select a place close to the supply socket of air conditioner and enough space should be kept near the machine.

(9) Those electrical appliances such as television, instruments, devices, artwork, piano, wireless equipment and other valuables should not be placed under the indoor unit and over 1m away from the daylight lamp as to prevent condensate from dropping into them and causing damage.

2. The following steps can be taken after selecting the installation place:

Cut a hole on the wall and put the connecting pipe and connecting thread into the PVC, which is purchased at the local shop. With a slight downwards tilt towards the exterior, the gradient should be kept at least 1/100. before cutting the hole, check if there are pipes or reinforcing steel bars at the rear of the hole. Making the hole in the place with wires or pipes should be avoided.

Installation Procedures

3. Installation Drawing of Indoor Units:

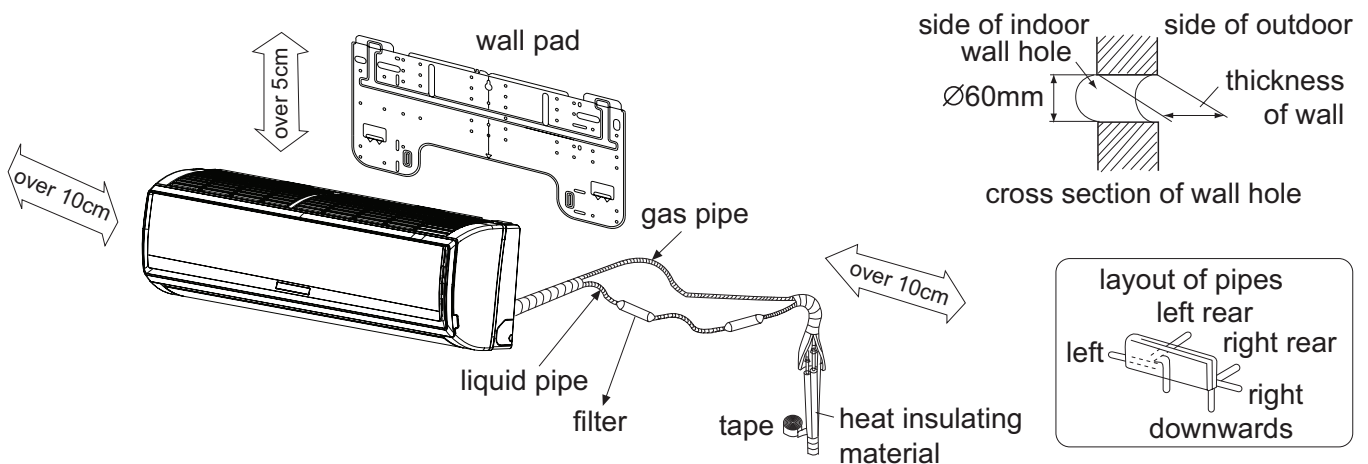

(1) Positioning Wall Pad & Locating Wall Holes

Fix the pad according to the installation location and the pipe layout of indoor unit (please refer to the installation drawing).

Installation should be done under the crossbeam or on the flat wall near the pillar. First fix the pad with a steel nail on the wall.

Drop a thread with a bolt through the pad center or use a level meter to find the level.

Then fix it with a concrete steel nail, (if it is fixed by the expansion bolts, drill holes on the wall according to the pad position with the electric drill (bore: 4.8mm, put the plastic sleeves into the holes, stick the panel onto the wall, and then position the pad with 4×25 bolts) and measure the position of the wall hole A.

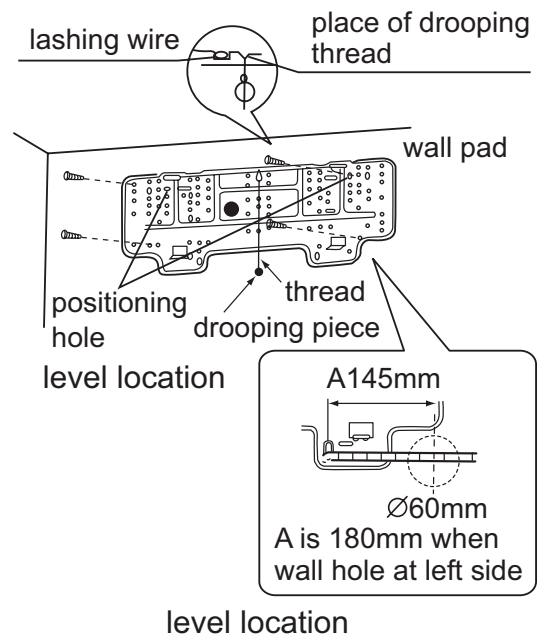

(2) Drilling Hole & Mounting Guard Ring

Drill a hole of 60mm bore with a slight tilt downwards to the outside, mount the guard ring, and seal it with gesso or putty after finishing the installation.

(3) Arranging Wiring of Indoor Unit

Arrange the layout of connection pipe, drain pipe, connecting line, signal line and air refreshing pipe according to the locations of your indoor unit, outdoor unit and wall holes, with drainage hose lower, connecting line upper. Intercrossing winding is not allowed between the mains line and the connecting line, and the drain pipe (especially in the indoor unit and the inside of machine) should be wined with heat insulating materials for heat preservation.

Installation Procedures

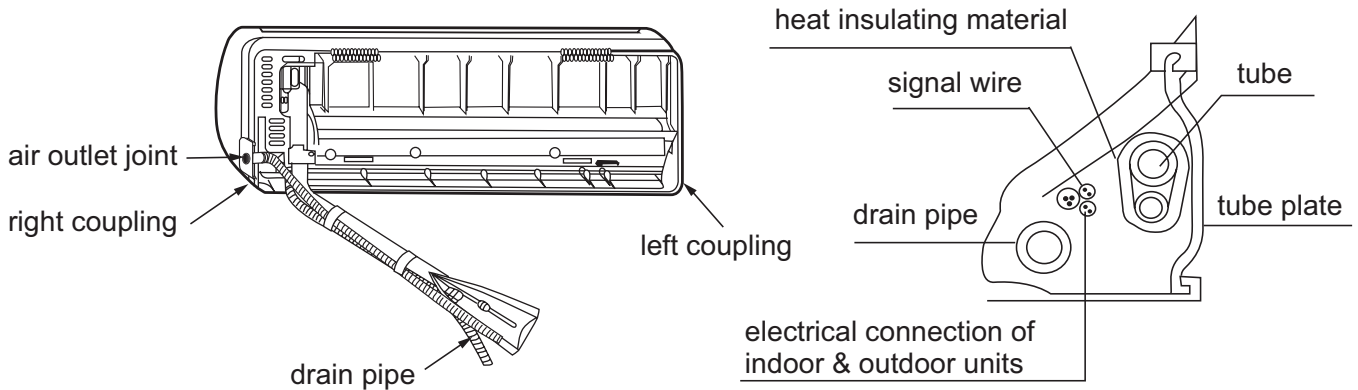

(4) Lead the connection tubing(liquid pipe and gas pipe) through the hole into the wall, or connect piping and wiring of indoor unit(check the number of wiring terminals of indoor and outdoor units and connect terminals with the same number and color), and then put the connection tubing and the connecting line through from the inside wall for the connection with outdoor unit.

Tube Permissible Length & Height Difference

Please refer to the attached manual of outdoor units.

Tube Materials & Specifications

Model		HAV007-012	HAV018 HAV024
Tubing Size (mm)	Gas pipe	Ø12.7	Ø15.88
	Liquid pipe	Ø6.35	Ø9.52
Tubing Material	Phosphor deoxybronze seamless pipe (TP ₂) for air conditioner		

Refrigerant Filling Amount

Add the refrigerant according to the installation instruction of outdoor unit. The addition of R410A refrigerant must be performed with a measure gage to ensure the specified amount or compressor failure can be caused by filling too much or little refrigerant.

Connecting Procedures of Refrigerant Tubing

Proceed the flare tube connecting operation to connect all the refrigerant tubes.

- Dual wrenches must be used in the connection of indoor unit tubing.
- Mounting torque refers to the right table

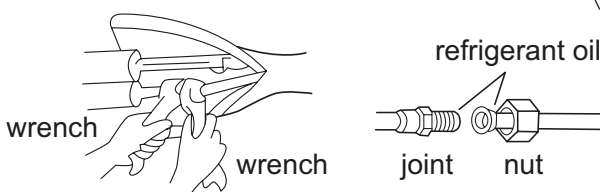

Outer Diameter of Tubing (mm)	Mounting Torque (N-m)	Increase mounting Torque (N-m)
Ø6.35	11.8(1.2kgf-m)	13.7(1.4kgf-m)
Ø9.52	24.5(2.5kgf-m)	29.4(3.0kgf-m)
Ø12.70	49.0(5.0kgf-m)	53.9(5.5kgf-m)
Ø15.88	78.4(8.0kgf-m)	98.0(10.0kgf-m)
Ø19.05	98.0(10.0kgf-m)	117.7(12.0kgf-m)

Installation Procedures

Cutting and Enlarging

Cutting or enlarging pipes should be proceeded by installation personnel according to the operating criterion if the tube is too long or flare opening is broken.

Vacuumizing

Vacuumize from the stop valve of outdoor units with vacuum pump. Refrigerant sealed in indoor machine is not allowed to use for vacuumization.

Open All Valves

Open all the valves of outdoor units. [NB: oil balancing stop valve must be shut up completely when connected one main unit.]

Checkup for Air Leakage

Check if there is any leakage at the connecting part and bonnet with hydrophone or soapsuds.

Connecting

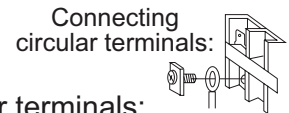

1. Connecting circular terminals:
The connecting method of circular terminal is shown in the Fig. Take off the screw, connect it to the terminal tier after heading it through the ring at the end of the lead and then tighten it.

2. Connecting straight terminals:
The connection methods for the circular terminals are shown as follows: loosen the screw before putting the line terminal into the terminal tier, tighten the screw and confirm it has been clamped by pulling the line gently.

3. Pressing connecting line
After connecting line is completed, press the connecting line with clips which should press on the protective sleeve of the connecting line.

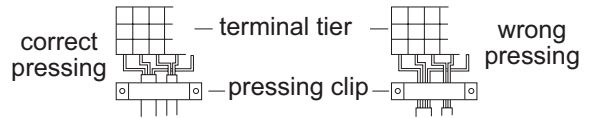

Installing and Dismantling Indoor Unit

1. Installation

During the installation of this series machines, fasten the wall pad on the wall first, hang the machine on the pothook, push it towards the wall pad until the sound of 'pa' 'pa' is heard. At this time, the agraffes of the indoor unit have hitched on the pad, as shown in the Fig.1 with dotted line.

2. Dismantling

During dismantling this series machines, push agraffes at the bottom of indoor unit upwards to release them, as shown in Fig.3, and pull up the bottom of indoor unit outwards gently and then raise the unit upwards in the bevel direction to release the pothook at the upper part of the wall pad, as shown in Fig.3.

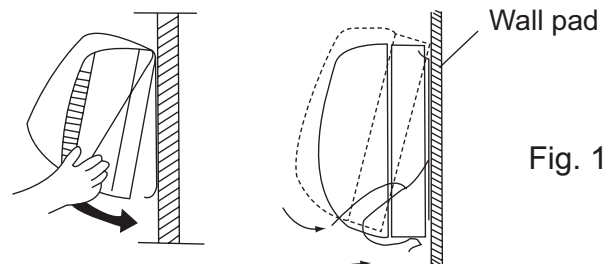

Fig. 1

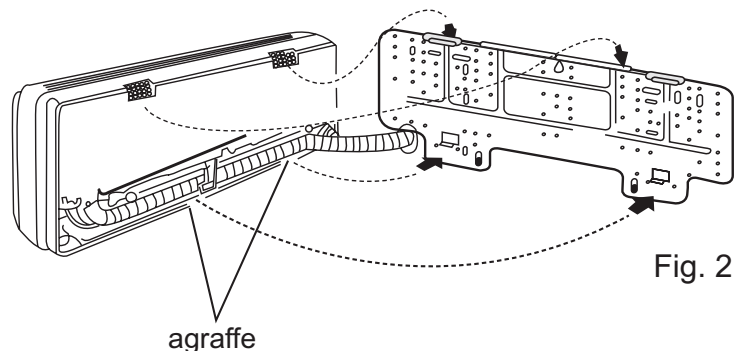

Fig. 2

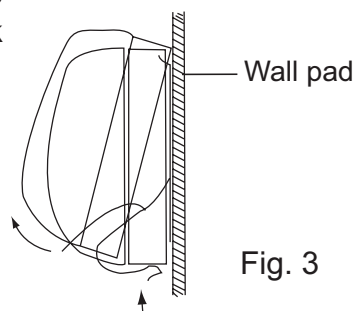

Fig. 3

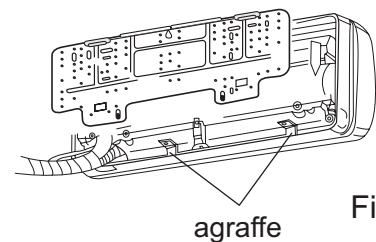

Fig. 4

Electrical Wiring

⚠ Warning

- Electrical construction should be made with specific mains circuit by the qualified personnel according to the installation instruction. Electric shock and fire may be caused if the capacity of power supply is not sufficient. ❗
- During arranging the wiring layout, specified cables should be used as the mains line, which accords with the local regulations on wiring. Connecting and fastening should be performed reliably to avoid the external force of cables from transmitting to the terminals. Improper connection or fastness may lead to burning or fire accidents. ❗
- There must be the ground connection according to the criterion. Unreliable grounding may cause electrical shocks. Do not connect the grounding line to the gas pipe, water pipe, lightening rod and telephone line. ❗

⚠ Attention

- Only copper wire can be used. Breaker for electric leakage should be provided, or electric shock may occur.
- The wiring of the mains line is of Y type. The power plug L should be connected to the live wire and plug N connected to null wire while \oplus should be connected to the ground wire. For the type with auxiliary electrically heating function, the live wire and the null wire should not be misconnected, or the surface of electrical heating body will be electrified. If the power line is damaged, replace it by the professional personnel of the manufacturer or service center.
- The power line of indoor units should be arranged according to the installation instruction of indoor units.
- The electrical wiring should be out of contact with the high-temperature sections of tubing as to avoid melting the insulating layer of cables, which may cause accidents.
- After connected to the terminal tier, the tubing should be curved into be a U-type elbow and fastened with the pressing clip.
- Controller wiring and refrigerant tubing can be arranged and fixed together. ❗
- The machine can't be powered on before electrical operation. Maintenance should be done while the power is shut down.
- Seal the thread hole with heat insulating materials to avoid condensation.
- Signal line and power line are separately independent, which can't share one line. [Note: the power line, signal line are provided by users. Parameters for power lines are shown as below: $3 \times (1.0-1.5) \text{ mm}^2$; parameters for signal line: $2 \times (0.75-1.25) \text{ mm}^2$ (shielded line)]
- 5 butt lines (1.5mm) are equipped in the machine before delivery, which are used in connection between the valve box and the electrical system of the machine. The detailed connection is displayed in the circuit diagram.

Supply Wiring Drawing

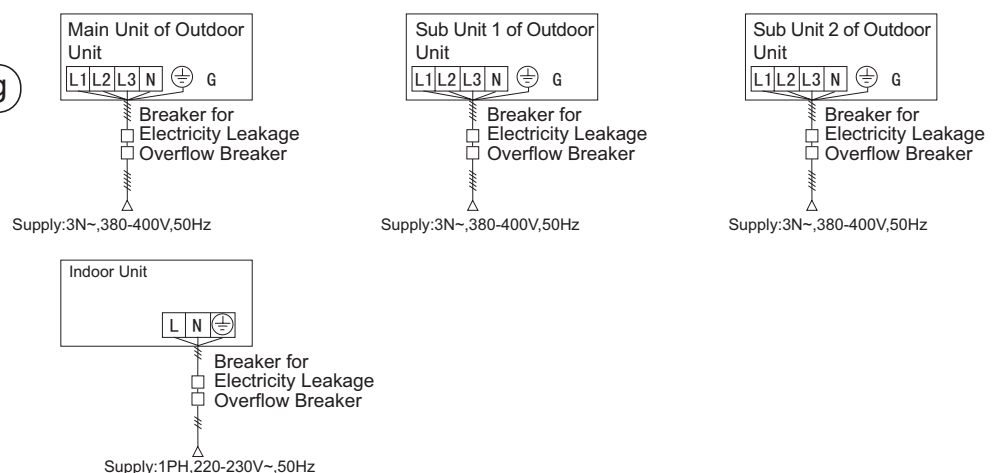

- Indoor units and outdoor units should be connected to the power source separately. Indoor units must share one single electrical source, but its capacity and specifications should be calculated. Indoor & outdoor units should be equipped with the power leakage breaker and the overflow breaker.
- An all-pole disconnection switch having a contact separation of at least 3mm in all poles should be connected in fixed wiring.

Electrical Wiring

Signal Wiring Drawing

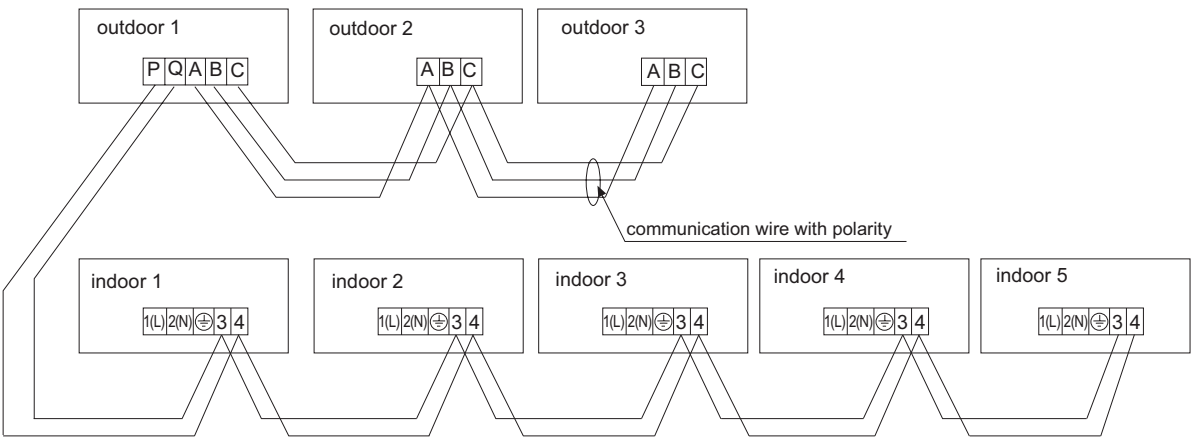

The combination of multiple indoor units can be controlled by remote controller.
 Note: HAV models are set to remote- controlled type.

The wiring for the power line of indoor unit, the wiring between indoor and outdoor units as well as the wiring between indoor units:

Total Current of Indoor Units(A)	Items	Cross Section (mm ²)	Length (m)	Rated Current of Overflow Breaker(A)	Rated Current of Power Leakage Breaker (A) Leaking Current(mA) Operating Period (S)	Cross Sectional Area of Signal Line	
						Outdoor -indoor (mm ²)	Indoor -indoor (mm ²)
< 10		2	20	20	20 A, 30 mA, 0.1S or below	2 cores × 0.75-2.0 mm ² shielded line	
≥ 10 and < 15		3.5	25	30	30 A, 30 mA, 0.1S or below		
≥ 15 and < 22		5.5	30	40	40 A, 30 mA, 0.1S or below		
≥ 22 and < 27		10	40	50	50 A, 30 mA, 0.1S or below		

- ※ Power cable model: H05VV-F
- ※ The diameter of earth cable cannot be smaller than power cable's.
- ※ The electrical power line and signal lines must be fastened tightly.
- ※ Every indoor unit must have the ground connection.
- ※ The power line should be enlarged if it exceeds the permissible length.
- ※ Shielded lays of all the indoor and outdoor units should be connected together, with the shielded lay at the side of signal lines of outdoor units grounded at one point.
- ※ It is not permissible if the whole length of signal line exceeds 1000m.

Code Setting

- ※ The code is dialed to "ON" position with the overline at the state of strapping if the code or overline status is "1"; The code is dialed to "OFF" position with the overline at the state of disconnection if the code or overline status is "0".
- ※ In the table below, the choice in the box "□" refers to the setting of the socket/overline before delivery.

Electrical Wiring

A. SW01 definition:

SW01: function selection, 26 degree lock setting, passive element setting and indoor capacity setting.

SW01_1	pre-set	pre-set				pre-set
SW01_2	function selection	0				[AUTO] [HEAT] [DRY] [COOL] [FAN]
		1				[DRY] [COOL] [FAN]
SW01_3	26 degree lock setting	0				26 degree lock null
		1				26 degree lock valid
SW01_4	passive element setting	0				passive element null
		1				passive element valid
SW01_5 SW01_6 SW01_7 SW01_8	indoor capacity setting	[5]	[6]	[7]	[8]	indoor capacity setting
		0	0	0	0	0.6HP
		0	0	0	1	0.8HP(HAV007)
		0	0	1	0	1.0HP(HAV009)
		0	0	1	1	1.2HP(HAV012)
		0	1	0	0	1.5HP
		0	1	0	1	1.7HP
		0	1	1	0	2.0HP(HAV018)
		0	1	1	1	2.5HP
		1	0	0	0	3.0HP
		1	0	0	1	3.2HP
		1	0	1	0	4.0HP
		1	0	1	1	5.0HP
		1	1	0	0	6.0HP
		1	1	0	1	8.0HP
1	1	1	0	10.0HP		
1	1	1	1	15.0HP		

B. SW08 definition:

SW08: temperature compensation selection and quiet function selection

SW08_1	temperature compensation selection	0	Temp. compensation 6 degree available (heating)
		1	Temp. compensation 6 degree unavailable (heating)
SW08_2	quiet function selection	0	quiet function valid
		1	quiet function null

Electrical Wiring

C. SW03 definition:

SW03: communication address setting between indoor and outdoor

SW03_1	address setting type	0		auto setting (default)							
		1		dip switch setting							
SW03_2 ~ SW03_8	communication address and central control address by dip switch (*note)	[2]	[3]	[4]	[5]	[6]	[7]	[8]	communication address	central control address	
		0	0	0	0	0	0	0	0	0#(default)	0#(default)
		0	0	0	0	0	0	0	1	1#	1#
		0	0	0	0	0	0	1	0	2#	2#
	
		0	1	1	1	1	1	1	1	63#	63#
		1	0	0	0	0	0	0	0	0#	64#
		1	0	0	0	0	0	0	1	1#	65#
		1	0	0	0	0	0	1	0	2#	66#
	
		1	1	1	1	1	1	1	1	63#	127#

*Note:

When connecting central controller, gateway or counting system, set address by dip switch.

Electrical Wiring

Description for digital tube on remote receiver

- (1) Being electrified for the first time, digital tube displays "88", then turns OFF about 3 seconds.
- (2) Unit stop state: nothing display and shows OFF.
- (3) Unit run state: digital tube displays the set temperature, 2 seconds later it displays indoor ambient temperature. If the set temperature changes, it will display the set temperature, 2 seconds later it displays indoor ambient temperature.
- (4) When indoor or outdoor failure occurs, the digital tube displays failure code: the format is "EXX", if failure code is more than 9, it will sliding display automatically.
- If indoor is faulty, it displays indoor failure code.
 - If indoor is not faulty, it displays outdoor failure code. Outdoor failure code will be displayed E20 in sliding type generally.
- (5) Data query:
- Entrance condition: set auto fan speed by remote controller, and press swing up/down for 8 times within 5 seconds, 2seconds later, the buzzer sounds 3 times, the digital tube will flash and display data.
 - Display information:

Set temp. by remote control	Data query	remarks
16	Indoor sensor Tai temperature	Display integer, if temp. less than -9 degree, sliding display.
17	Indoor sensor TC1 temperature	
18	Indoor sensor TC2 temperature	
19	Indoor PMV open angle	Display integer, if open angle more than 99pls, sliding display.
20	Indoor communication address	Display integer
21	Indoor central control address	Display integer
22~30	No definition	--

Note: In the course of data query:

Remote controller setting demand is null. (the set temperature shows the data to be checked)
Digital tube will flash to display data.

- Quit condition: remote controller sets unit stop or no remote signal is received within 60 seconds.

LED on remote receiver description

- (1) Being electrified for the first time, LED is ON, about 3 seconds later, being OFF.
- (2) On unit stop, LED is OFF.
- (3) On unit running,
- ON/OFF indicator: LED1: without fresh air setting, LED1 is red; with fresh air, LED1 is green.
 - Timer/sleep indicator: LED2: with timer or sleep function, LED2 is on, and yellow; or LED2 is off.
 - Compressor running indicator: LED3: indoor Thermostat On and compressor running, LED3 is on and green; or LED3 is off.

Test Run & Fault Code

Before Test Run

- Before switching it on, test the supply terminal tier (L, N terminals) and grounding points with 500V megaohm meter and check if the resistance is above $1M\Omega$. It can't be operated if it is below $1M\Omega$.
- Connect it to the power supply of outdoor units to energize the heating belt of the compressor. To protect the compressor at startup, power it on 12 hours prior to the operation.

Check if the arrangements of the drainpipe and connection line are correct.

The drainpipe shall be placed at the lower part while the connection line placed at the upper part. Heat preservation measures should be taken such as winding the drainpipe esp. in the indoor units with heating insulating materials.

The drain pipe should be made a slope type to avoid protruding at the upper part and concaving at the lower part on the way.

Checkup of Installation

- check if the mains voltage is matching
- check if there is air leakage at the piping joints
- check if the connections of mains power and indoor & outdoor units are correct
- check if the serial numbers of terminals are matching
- check if the installation place meets the requirement
- check if there is too much noise
- check if the connecting line is fastened
- check if the connectors for tubing are heat insulated
- check if the water is drained to the outside
- check if the indoor units are positioned

Ways of Test Run

Do ask the installation personnel to make a test run. Take the testing procedures according to the manual and check if the temperature regulator works properly.

When the machine fails to start due to the room temperature, the following procedures can be taken to do the compulsive running. The function is not provided for the type with remote control.

- Set the wired controller to refrigerating/heating mode, press "ON/OFF" button for 5 seconds to enter into the compulsive refrigerating/heating mode. Re-press "ON/OFF" button to quit the compulsive running and stop the operation of the air conditioner.

Test Run & Fault Code

Fault Remedies

If the failure occurs, the digital tube on remote receiver will display failure code, also you can adjust by LED5 on PCB flash times.

LED5 on PCB flash times	Display on digital tube	Fault descriptions
1	E1	Ambient temperature sensor Tai failure
2	E2	Coil temp. sensor TC1 failure
3	E3	Coil temp.sensor TC2 failure
5	E5	EEPROM data incorrect
6	E6	Communication between indoor and outdoor failure
9	E9	Indoor address repeated
14	E14	DC motor failure
20	E20	Outdoor failure

Disposal

DISPOSAL:

Do not dispose this product as unsorted municipal waste. Collection of such waste separately for special treatment is necessary.

It is prohibited to dispose of this appliance in domestic household waste.

For disposal there are several possibilities:

- a) The municipality has established collection systems, where electronic waste can be disposed of at least free of charge to the user.
- b) When buying a new product, the retailer will take back the old product at least free of charge.
- c) The manufacturer will take back the old appliance for disposal at least free of charge to user.
- d) As old products contain valuable resources, they can be sold to scrap metal dealers.

Wild disposal of waste in forests and landscapes endangers your health when hazardous substances leak into the ground-water and find their way into the food chain.

