

Airwell

Service Manual

WFD012

UNITS

AWWR-WFD012-C11



SM WFD GB

AVRIL 2017

Version:1

Table of Contents

Part I :Technical Information	1
1.Summary	1
.....	2
3.Outline Dimension Diagram	4
4.Refrigerant System Diagram	5
5.Electrical Part	6
5.1 Wiring Diagram	6
5.2 PCB Printed Diagram.....	7
6.Function and Control	9
6.1 Introduction of Control Panel.....	9
6.2 Introduction of Remote Controller	10
6.3 Function Introduction.....	13
Part II :Installation and Maintenance	15
7.Notes for Installation and Maintenance	15
8.Installation	18
8.1 Selection of Installation Location.....	18
8.2 Electric Connection Requirement.....	18
8.3 Installation Procedure	19
8.4 Installation of Accessories.....	19
8.5 Drain Water	19
9.Maintenance	20
9.1 Malfunction Analysis.....	20
9.2 Flashing LED of Indoor/Outdoor Unit and Primary Judgement.....	25
10.Exploded View and Parts List	35
11.Removal Procedure	37
Appendix:	43
Appendix 1: Reference Sheet of Celsius and Fahrenheit	43
Appendix 2: List of Resistance for Ambient Temperature Sensor	44

Model			AWWR-WFD012-C11
Product Code			7WT010009
Power Supply	Rated Voltage	V~	230
	Rated Frequency	Hz	50
	Phases		1
Cooling Capacity		W	3650
Heating Capacity		W	/
Cooling Power Input		W	1030
Heating Power Input		W	/
Cooling Current Input		A	4.6
Heating Current Input		A	/
Rated Input		W	1300
Rated Current		A	6.5
Air Flow Volume(H/M/L)		m ³ /h	480/430/380
Dehumidifying Volume		L/h	1.6
EER		WW	3.54
COP		W/W	/
Application Area		m ²	16-24
Climate Type			T1
Isolation			I
Moisture Protection			IP24
Design Pressure Hi. Side		MPa	4.3
Design Pressure Low Side		MPa	2.5
Dimension (WXHXD)		mm	660X428X700
Dimension of Carton Box (LXWXH)		mm	790X736X490
Dimension of Package (LXWXH)		mm	793X739X505
Net Weight		kg	50
Gross Weight		kg	54
Refrigerant			R32
Refrigerant Charge		kg	0.63
Indoor Side	Fan Type		Centrifugal
	Fan Diameter Length(DXL)	mm	Φ193.1X80.9
	Cooling Speed	r/min	870/800/730
	Heating Speed	r/min	/
	Fan Motor Power Output	W	100
	Fan Motor RLA	A	0.51
	Fan Motor Capacitor	μF	4
	Electric Heating Power Input	W	/
	Evaporator Form		Aluminum Fin-copper Tube
	Evaporator Pipe Diameter	mm	Φ7
		mm	3-1.3
	Evaporator Coil Length (LXDXW)	mm	401X38.1X381
	Swing Motor Model		MP28ED
	Swing Motor Power Output	W	4
	Fuse Current	A	3.15
Sound Pressure Level (H/M/L)	dB (A)	50/48/46	
Sound Power Level (H/M/L)	dB (A)	59/57/55	

Outdoor Side	Compressor Manufacturer		ZHUHAI LANDA COMPRESSOR CO.,LTD
	Compressor Model		QXF-B096zC190
	Compressor Oil		FW68DA or equivalent
	Compressor Type		Rotary
	Compressor LRA.	A	/
	Compressor RLA	A	4.5
	Compressor Power Input	W	940
	Compressor Overload Protector		1NT11L-6233/KSD115°C /HPC115/95U1
	Throttling Method		Capillary
	Set Temperature Range	°C	16~30
	Cooling Operation Ambient Temperature Range	°C	16~43
	Heating Operation Ambient Temperature Range	°C	/
	Condenser Form		Aluminum Fin-copper Tube
	Condenser Pipe Diameter	mm	Φ5+Φ7
		mm	3-1.3+1-1.5
	Condenser Coil Length (LXDXW)	mm	685X34.2X381+578X12.7X76.2
	Fan Motor Speed (H/M/L)	rpm	870/800/730
	Fan Motor Power Output	W	100
	Fan Motor RLA	A	0.51
	Fan Motor Capacitor	μF	4
	Outdoor Unit Air Flow Volume	CFM	1200
	Fan Type		
	Fan Diameter	mm	Φ391
Sound Pressure Level (H/M/L)	dB (A)	58/56/54	
Sound Power Level (H/M/L)	dB (A)	65/63/61	
Defrosting Method		/	

The above data is subject to change without notice; please refer to the nameplate of the unit.

5.2 PCB Printed Diagram

5.2.1 Silk screen on main board

•Top view

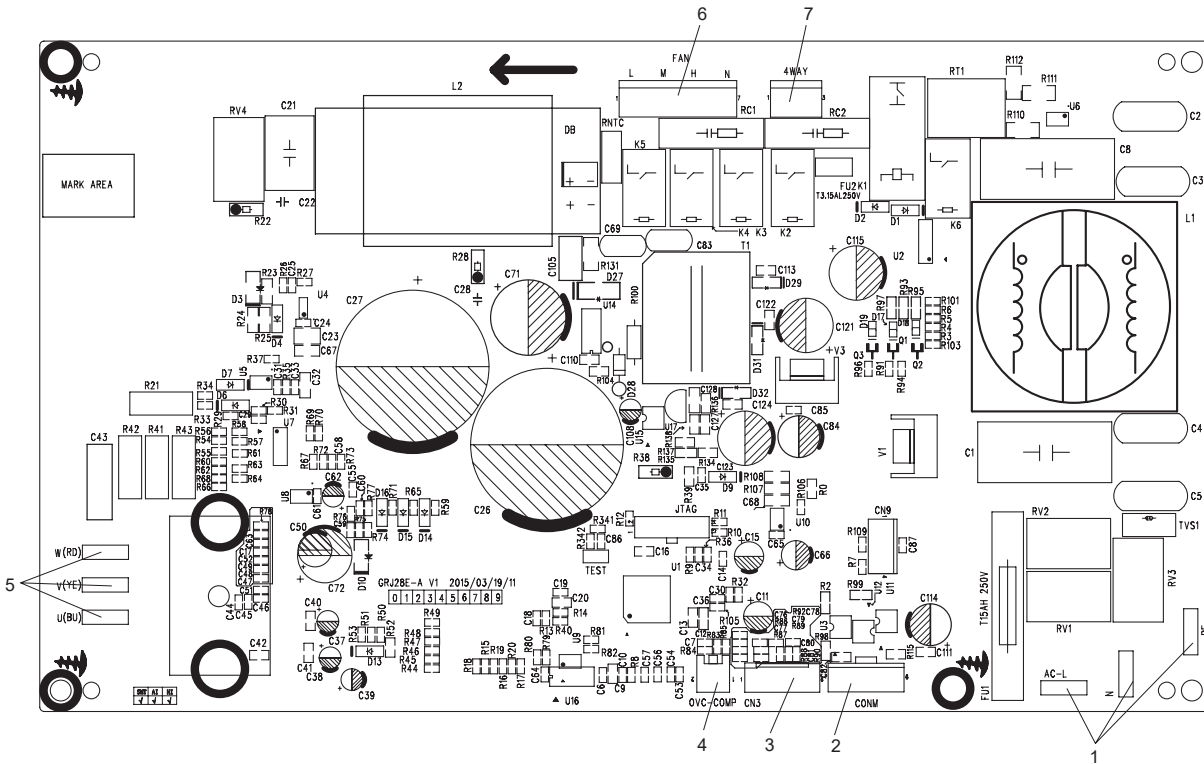

1	Interfaces for neutral wire, live wire and earthing wire	5	U/V/W interface of compressor
2	Communication interface	6	Interface of AC fan
3	Interface of temperature sensor	7	Interface of 4-way valve (reserved)
4	Interface of overload protection of compressor		

•Bottom view

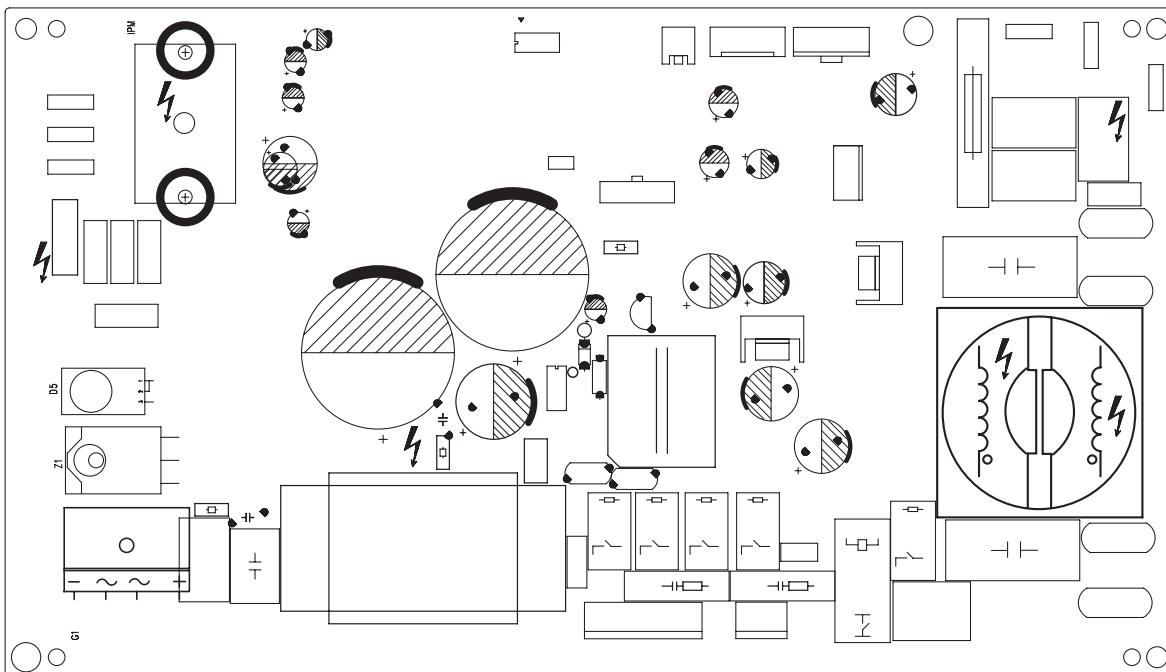

6.2 Introduction of Remote Controller

Buttons on Remote Controller

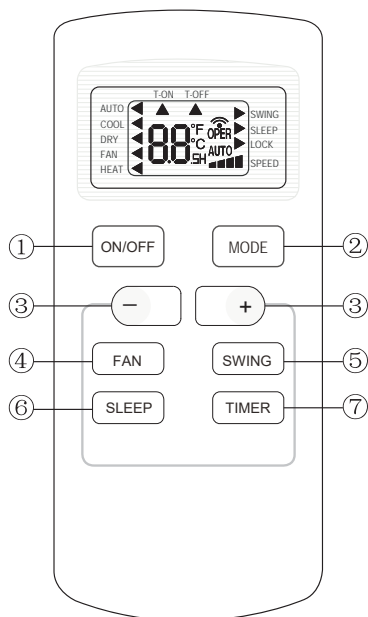

①: **ON/OFF** button

②: **MODE** button

③: **+/-** button

④: **FAN** button

⑤: **SWING** button

⑥: **SLEEP** button

⑦: **TIMER** button

Icon Display on Remote Controller

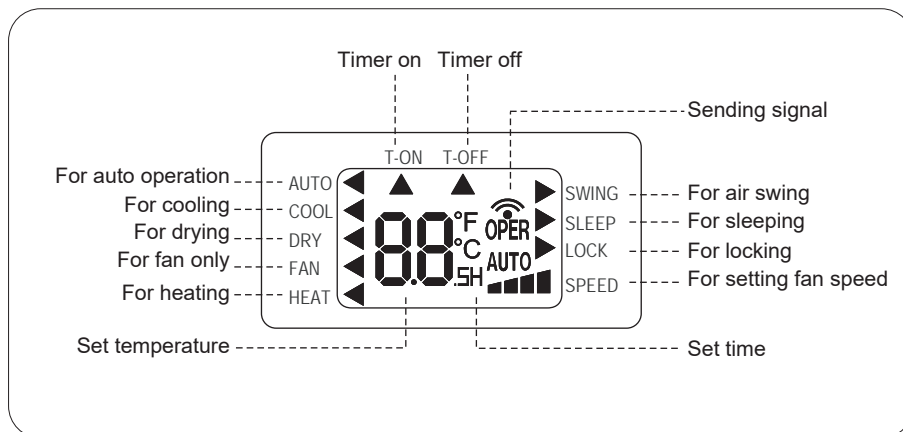

Operation introduction of remote controller

- Note:**
- ◆ When power is connected(stand by condition), you can operate the air conditioner through the remote controller.
 - ◆ When unit is on, each time you press the button on remote controller, the sending signal icon  on the display of remote controller will blink once. If the air conditioner gives out a beep sound, it means the signal has been sent.
 - ◆ When unit is off, set temperature will be displayed on the remote controller(If the light of indoor unit display is turned on, the corresponding icon will be displayed); When unit is on, it will display the icon of the on-going function.

1. ON/OFF Button

Press this button to turn unit on/off.

2. MODE Button

Pressing this button once can select your required mode circularly as below(the corresponding icon  will be lit up after the mode is selected):



- ◆ When selecting auto mode, air conditioner will operate automatically according to ex-factory setting. Set temperature can't be adjusted and won't be displayed either. Press FAN button to adjust fan speed.
- ◆ When selecting cool mode, air conditioner will operate under cool mode. Then press + or -- button to adjust set temperature. Press FAN button to adjust fan speed.
- ◆ When selecting dry mode, air conditioner will operate at low fan speed under dry mode. In dry mode, fan speed can't be adjusted.
- ◆ When selecting fan mode, air conditioner will operate in fan mode only. Then press FAN button to adjust fan speed.
- ◆ When selecting heat mode, air conditioner will operate under heat mode. Then press + or -- button to adjust set temperature. Press FAN button to adjust fan speed. (This function is not available in this air conditioner.)

3. +/- button

- ◆ Pressing + or - button once will increase or decrease set temperature by 1 °F(°C). Hold + or -- button for 2s, set temperature on remote controller will change quickly. Release the button after your required set temperature is reached.
- ◆ When setting Timer On, Timer Off or Clock, press + or -- button to adjust the time (See TIMER Button for setting details).

4. FAN Button

Pressing this button can select fan speed circularly as: AUTO, SPEED 1 (●), SPEED 2 (▂), SPEED 3 (▃), SPEED 4 (▄) (unavailable in this air conditioner. Speed 4 is the same with speed 3).

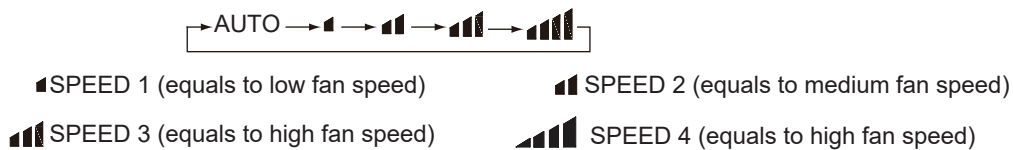

Note:

- ◆ Under Auto mode, air conditioner will select proper fan speed automatically according to ex-factory setting.
- ◆ Fan speed can't be adjusted under Dry mode.

5. SWING Button

Press this button to turn on left & right air swing.

6. SLEEP Button

Under Cool, Heat, Dry mode, press this button to turn on Sleep function. Press this button to cancel Sleep function. Under Fan and Auto mode, this function is unavailable.

7. TIMER Button

- ◆ When unit is on, press this button to set Timer Off. T-OFF and H icon will be blinking. Within 5s, press + or - button to adjust the time for Timer Off. Pressing + or - button once will increase or decrease the time by 0.5h. Hold + or - button for 2s, time will change quickly. Release the button after your required set time is reached. Then press TIMER button to confirm it. T-OFF and H icon will stop blinking.
- ◆ When unit is off, press this button to set Timer On. T-ON and H icon will be blinking. Within 5s, press + or - button to adjust the time for Timer On. Pressing + or - button once will increase or decrease the time by 0.5h. Hold + or - button for 2s, time will change quickly. Release the button after your required set time is reached. Then press TIMER button to confirm it. T-ON and H icon will stop blinking.

Note:

- ◆ Range of time setting is: 0.5~24h.
- ◆ The interval between two motions can't exceed 5s, otherwise the remote controller will exit setting status.

Simple operationfirst

1. After putting through power "ON/OFF" button on remote controller to turn on the air conditioner.
2. Press "MODE" button to select your required operation mode: AUTO, COOL, DRY, FAN.
3. Press "+" or "-" button to select your required temperature. (temperature can't adjusted under AUTO mode)
4. Press "FAN" button to select your required fan speed: auto, first notch, second notch, third notch, fourth notch (fourth notch is same as third notch for this air conditioner.)

Replacement of Batteries in Remote Controller

1. Press the back side of remote controller on the spot marked with , and then push out the cover of battery box along the arrow direction.
2. Replace two No.7 (AAA 1.5V) dry batteries and make sure the positions of + and -- polar are correct.
3. Reinstall the cover of battery box.

Note:

- ◆ During operation, point the signal sender of the remote controller at the receiving window of the indoor unit;
- ◆ The distance between signal sender and receiving window should be within 8m. There should be no obstacle between them.
- ◆ Signal may be interfered easily in the room where there is fluorescent lamp or wireless telephone; Remote controller should be close to indoor unit during operation.
- ◆ Replace new batteries of the same model when replacement is required.
- ◆ If you don't use remote controller for a long time, please take out the batteries.
- ◆ If the display on remote controller is fuzzy or if there's no display, please replace batteries.

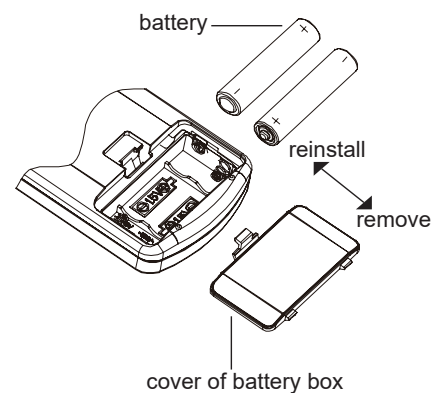

6.3 Function Introduction

I Basic functions:

一、Cooling mode

1. Working condition and process for cooling:

- When Tinner amb. $\geq T_{\text{preset}}$, the unit operates under cooling mode. Meanwhile, the fan and the compressor operate, and the fan operates at set fan speed;
 - When Tinner amb. $\leq T_{\text{preset}} - 2^{\circ}\text{C}$, the compressor stops operation, and the fan operates at set fan speed;
 - When $T_{\text{preset}} - 2^{\circ}\text{C} < \text{Tinner amb.} < T_{\text{preset}}$, the unit keeps previous operation status.
 - When turning off the unit, the compressor stops operation. The fan will stop operation after operating at low fan speed for another 30s.
2. Under cooling mode, the temperature setting range is $16^{\circ}\text{C} \sim 30^{\circ}\text{C}$. When compressor stops operation due to malfunction, the fan and the swing fan operate at original status.

二、Drying mode

1. Working condition and process for drying:

- When Tinner amb. $> T_{\text{preset}}$, the unit operates at drying mode. Meanwhile, the fan and the compressor operate, and the fan is defaulted to operate at low fan speed;
- When $T_{\text{preset}} - 2^{\circ}\text{C} \leq \text{Tinner amb.} \leq T_{\text{preset}}$, the unit keeps the original operation status;
- When Tinner amb. $< T_{\text{preset}} - 2^{\circ}\text{C}$, compressor stops operation, and the fan is defaulted to operate at low fan speed.
- When turning off the unit, the compressor stops operation. The fan will stop operation after operating at low fan speed for another 30s.

2. In this mode, the temperature setting range is $16^{\circ}\text{C} \sim 30^{\circ}\text{C}$.

三、Auto mode

Working condition and process for auto operation

- When Tinner amb. $\geq 26^{\circ}\text{C}$, the unit operates at cooling mode and $T_{\text{preset}} = 25^{\circ}\text{C}$;
- When Tinner amb. $\leq 22^{\circ}\text{C}$, the unit operate at fan mode and $T_{\text{preset}} = 20^{\circ}\text{C}$;
- When $22^{\circ}\text{C} < \text{Tinner amb.} < 26^{\circ}\text{C}$, the unit keeps the original operation status;

四、Fan mode

Under the fan mode, compressor stops operation and the fan operates at set fan speed. Temperature can't be set by buttons on the control panel, while it can be set by remote controller.

II Buttons' function

1. ON/OFF:

It used to turn on or turn off the unit.

2. Mode:

It used to switch among cooling mode, drying mode and fan mode.

3. Fan speed:

It used to set high, medium, low or auto fan speed. The corresponding LED indicator is on (under drying mode, this button can't be adjusted. The fan speed is the low speed).

4. +/- button:

4.1 The temperature setting range is 0~24 hours. The timer can be set in 0.5 hour increments between 1 and 10 hours; or in 1 hour increments for 10 hours above.

4.2 Under temperature setting range, each push on +/- button will increase or decrease 1°C .

5. Swing:

Press this button to turn on swing function; press this button again to cancel swing function.

6. Timer function

6.1 Timer ON: Timer ON can be set under OFF status, and then Timer ON setting range is 0.5 ~ 24 hours. When the set time is reached, the system will operate at the preset mode.

6.2 Timer OFF: Timer OFF can be set under ON status, and then Timer OFF setting range is 0.5 ~ 24 hours. When the set time is reached, the system will stop operation.

7. The dual-8 nixie tube is defaulted to display $^{\circ}\text{C}$. The displays can switch among $^{\circ}\text{C}$ and $^{\circ}\text{F}$. Press "+" and "-" buttons simultaneously for 3s to switch them.

8. FILTER

f.

9. Sleeping mode:

9.1 When the initial temperature is set at $16 \sim 23^{\circ}\text{C}$, after turning on the sleeping function, the temperature will increase by 1°C every two hours. When the temperature is increased by 3°C , the temperature will not change any more. When the unit has operated for 7 hours, the temperature will decreased by 1°C . After that, the unit will operate at this time all the time.

9.2 When the initial temperature is set at $24 \sim 27^{\circ}\text{C}$, after turning on the sleeping function, the temperature will increase by 1°C every two hours. When the temperature is increased by 2°C , the temperature will not change any more. When the unit has operated for 7 hours, the temperature will decreased by 1°C . After that, the unit will operate at this time all the time.

9.3 When the initial temperature is set at $28 \sim 29^{\circ}\text{C}$, after turning on the sleeping function, the temperature will increase by 1°C every two hours. When the temperature is increased by 1°C , the temperature will not change any more. When the unit has operated for 7 hours, the temperature will decreased by 1°C . After that, the unit will operate at this time all the time.

9.4 When the initial temperature is set at 30°C , after turning on the sleeping function, the unit will operate at this temperature. When the unit has operated for 7 hours, the temperature will decreased by 1°C . After that, the unit will operate at this time all the time.

10. Fan

The fan can operate at high, medium, low or auto fan speed. The auto fan speed will automatically adjust the current operation status of the fan.

a. Auto fan speed under cooling mode:

$T_{\text{inner amb.}} \geq T_{\text{preset}} + 2^{\circ}\text{C}$ high fan speed

$T_{\text{preset}} < T_{\text{inner amb.}} < T_{\text{preset}} + 2^{\circ}\text{C}$ medium fan speed

$T_{\text{inner amb.}} \leq T_{\text{preset}}$ low fan speed

b. The fan speed under fan mode is same as that for cooling mode.

c. The auto fan under auto mode is controlled by the auto fan under its actual mode;

d. Only low fan speed under drying mode. When adjusting the fan speed button, only the low fan indicator is ON and the buzzer will give out a sound.

11. Power-off memory

The system will memorize the setting operation status (mode, set temperature, fan speed, timer) before power failure. Once power recovered, the unit will automatically operate at the set status before power failure.

Part II :Installation and Maintenance

7.Notes for Installation and Maintenance

Safety Precautions: Important!

Please read the safety precautions carefully before installation and maintenance.

The following contents are very important for installation and maintenance.

Please follow the instructions below.

- The installation or maintenance must accord with the instructions.
- Comply with all national electrical codes and local electrical codes.
- Pay attention to the warnings and cautions in this manual.
- All electric work must be performed by a licensed technician according to local regulations and the instructions given in this manual.
- Be caution during installation and maintenance. Prohibit incorrect operation to prevent electric shock, casualty and other accidents.



Warnings

Electrical Safety Precautions:

1. Cut off the power supply of air conditioner before checking and maintenance.
2. The air condition must apply specialized circuit and prohibit share the same circuit with other appliances.
3. The air conditioner should be installed in suitable location and ensure the power plug is touchable.

during installation and maintenance.

5. Have the unit adequately grounded. The grounding wire can't be used for other purposes.
6. Must apply protective accessories such as cable-cross loop and wire clip.
7. The live wire, neutral wire and grounding wire of power supply must be corresponding to the live wire, neutral wire and grounding wire of the air conditioner.
8. If power cord is broken, please get the specialized power cord from the manufacture or distributor.
9. If the power cord is not long enough, please get the specialized power cord from the manufacture or distributor. Prohibit prolong the wire by yourself.
10. Make sure all wires and pipes are connected properly.

11. Check if there is electric leakage on the unit body. If yes, please eliminate the electric leakage.
12. Replace the fuse with a new one of the same speci-

wire or conducting wire.

13. If the unit is to be installed in a humid place, the circuit breaker must be installed.

Installation Safety Precautions:

1. Select the installation location according to the requirement of this manual.(See the requirements in installation part)
2. Handle unit transportation with care; the unit should not be carried by only one person if it is more than 20kg.
4. Ware safety belt if the height of working is above 2m.
5. Use equipped components or appointed components during installation.
6. Make sure no foreign objects are left in the

Refrigerant Safety Precautions:

1. A poisonous gas; Prohibit prolong the connection pipe by welding.
2. . Never have it mixed with any other refrigerant. Never have air remain in the refrigerant line as it may lead to rupture or other hazards.
3. Make sure no refrigerant gas is leaking out when installation is completed.

measure to minimize the density of refrigerant.

5. Never touch the refrigerant piping or compressor without wearing glove to avoid scald or frostbite.

hazard, explosion, electric shock or injury.

Safety Precautions for Refrigerant

•To realize the function of the air conditioner unit, a special refrigerant circulates in the system. The used refrigerant is the

the greenhouse effect is also lower. R32 has got very good thermodynamic features which lead to a really high energy

WARNING:

•Do not use means to accelerate the defrosting process or to clean, other than those recommended by the manufacture. Should repair be necessary, contact your nearest authorized Service Centre. personnel may be dangerous. The appliance shall be stored in a room without continuously operating ignition sources. (for .)

•Do not pierce or burn.

's instructions only. Be aware that

refrigerants not contain odour.

•Read specialist's manual.

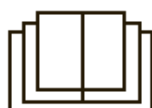

Safety Operation of Flammable Refrigerant

h the refrigeration system recognized by this industry. If it needs other technician to maintain and repair the appliance, they should be supervised by the person who bears the qualification for

•It can only be repaired by the method suggested by the equipment's manufacturer.

Installation notes

operating heater).

•It is not allowed to drill hole or burn the connection pipe.

•The air conditioner must be installed in a room that is larger than the minimum room area.

The minimum room area is shown on the nameplate or following table a.

•Leak test is a must after installation.

table a - Minimum room area(m²)

Minimum room area(m ²)	Charge amount (kg)	≤1.2	1.3	1.4	1.5	1.6	1.7	1.8	1.9	2	2.1	2.2	2.3	2.4	2.5
	floor location	/	14.5	16.8	19.3	22	24.8	27.8	31	34.3	37.8	41.5	45.4	49.4	53.6
wall mounted	/	5.2	6.1	7	7.9	8.9	10	11.2	12.4	13.6	15	16.3	17.8	19.3	
window mounted	/	1.6	1.9	2.1	2.4	2.8	3.1	3.4	3.8	4.2	4.6	5	5.5	6	
ceiling mounted	/	1.1	1.3	1.4	1.6	1.8	2.1	2.3	2.6	2.8	3.1	3.4	3.7	4	

Maintenance notes

•Check whether the maintenance area or the room area meet the requirement of the nameplate.

— It's only allowed to be operated in the rooms that meet the requirement of the nameplate.

•Check whether the maintenance area is well-ventilated.

— The continuous ventilation status should be kept during the operation process.

•Check whether the appliance mark is in good condition.

— Replace the vague or damaged warning mark.

Welding

●If you should cut or weld the refrigerant system pipes in the process of maintaining, please follow the steps as below:

- a. Shut down the unit and cut power supply
- b. Eliminate the refrigerant
- c. Vacuuming
- d. Clean it with N₂ gas
- e. Cutting or welding
- f. Carry back to the service spot for welding

●The refrigerant should be recycled into the specialized storage tank.

s well-ventilated.

Filling the refrigerant

each other.

when it's removed.

Safety instructions for transportation and storage

●According to the local rules and laws.

8. Installation

8.1 Selection of Installation Location

1. Basic requirement

Installing the unit in the following places may cause malfunction. If it is unavoidable, please consult the local dealer:

- (1)
- (2) The place with high-frequency devices (such as welding machine, medical equipment).
- (3) The place near coast area.
- (4) The place with oil or fumes in the air.
- (5) The place with sulfureted gas.
- (6) Other places with special circumstances.

2. Requirement of complete unit

- (1) There should be no obstruction near air inlet and air outlet.
- (2) Select a location where the condensation water can be dispersed easily and wont affect other people.
- (3) The location should be able to withstand the weight of indoor unit and wont increase noise and vibration.
fect neighborhood.
- (5) The location should be able to withstand the weight of unit.
- (6) Select a location which is out of reach for children and far away from animals or plants. If it is unavoidable, please add fence for safety purpose.

8.2 Electric Connection Requirement

1. Safety precaution

- (1) Must follow the electric safety regulations when installing the unit.
- (2)
- (3) Make sure the power supply matches with the requirement of air conditioner. Unstable power supply or incorrect wiring may result in
- (4) For appliances with type Y attachment, the instructions shall contain the substance of the following. If the supply cord is damaged, it must be replaced by the manufacturer
- (5) Properly connect the live wire, neutral wire and grounding wire of power socket.
- (6) Be sure to cut off the power supply before proceeding any work related to electricity and safety.

2. Grounding requirement

- (1)
Please make sure it is always grounded effectively, otherwise it may cause electric shock.
- (2) The yellow-green wire or green wire in air conditioner is grounding wire, which cant be used for other purposes.
- (3) The grounding resistance should comply with national electric safety regulations.

8.3 Installation Procedure

- (1) Remove the sticker from the front panel.
- (2) Put the unit into the installation hole.
 - When installing, make sure the unit is slanted downward to the back to minimize the noise and vibration of operation. (Slant by 6-10mm.)
- Make sure the installation place is strong enough to minimize the noise and vibration of operation.
- 3) Fill the gaps in the cabinet with sponge or foam.

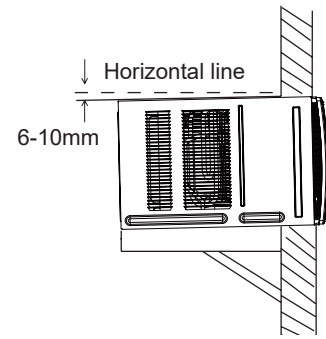

8.4 Installation of Accessories

- (1) To install iron support

Make sure the installation hole is strong enough to support the air conditioner. If not, install an iron support to hold the unit. The iron support should be on the outside of the building (See the right)
- (2) T

To avoid dropping anything onto the unit or exposing the unit to direct sunlight, contact your seller to install a sunshade baffle for the unit. When installing, make sure the air inlet at the side grille will not be blocked.

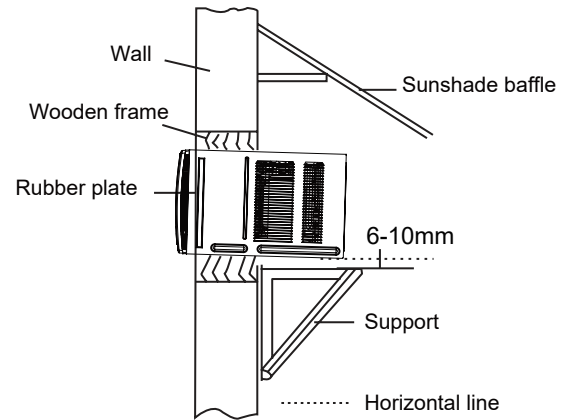

8.5 Drain Water

To maximize cooling efficiency, the air conditioner is designed to spray condensate onto the condenser coil.

For cooling only unit: Should the spraying sound annoy you, please adopt the method of outside drain with the following steps, which may however cause a small loss of performance.

- (1) Slide out the unit from the cabinet.
- (2) Remove the rubber plug from the body base plate.
- (3) Install the drain pan to the corner of the cabinet with 2 screws.
- (4) Connect the drain hose to the outlet on the bottom of the drain pan.
- (5) Slide the unit into its original place in the cabinet.

Note:

- Drain pan and drain hose must be installed before operation.
- Drain hose or tubing can be purchased locally to satisfy your particular needs.

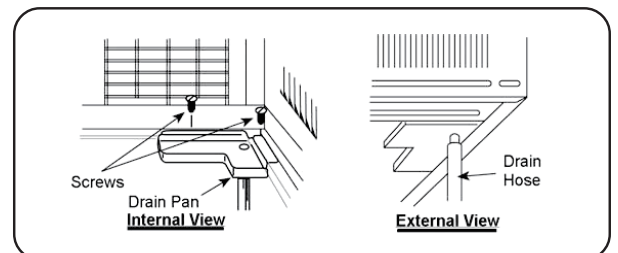

9. Maintenance

9.1 Malfunction Analysis

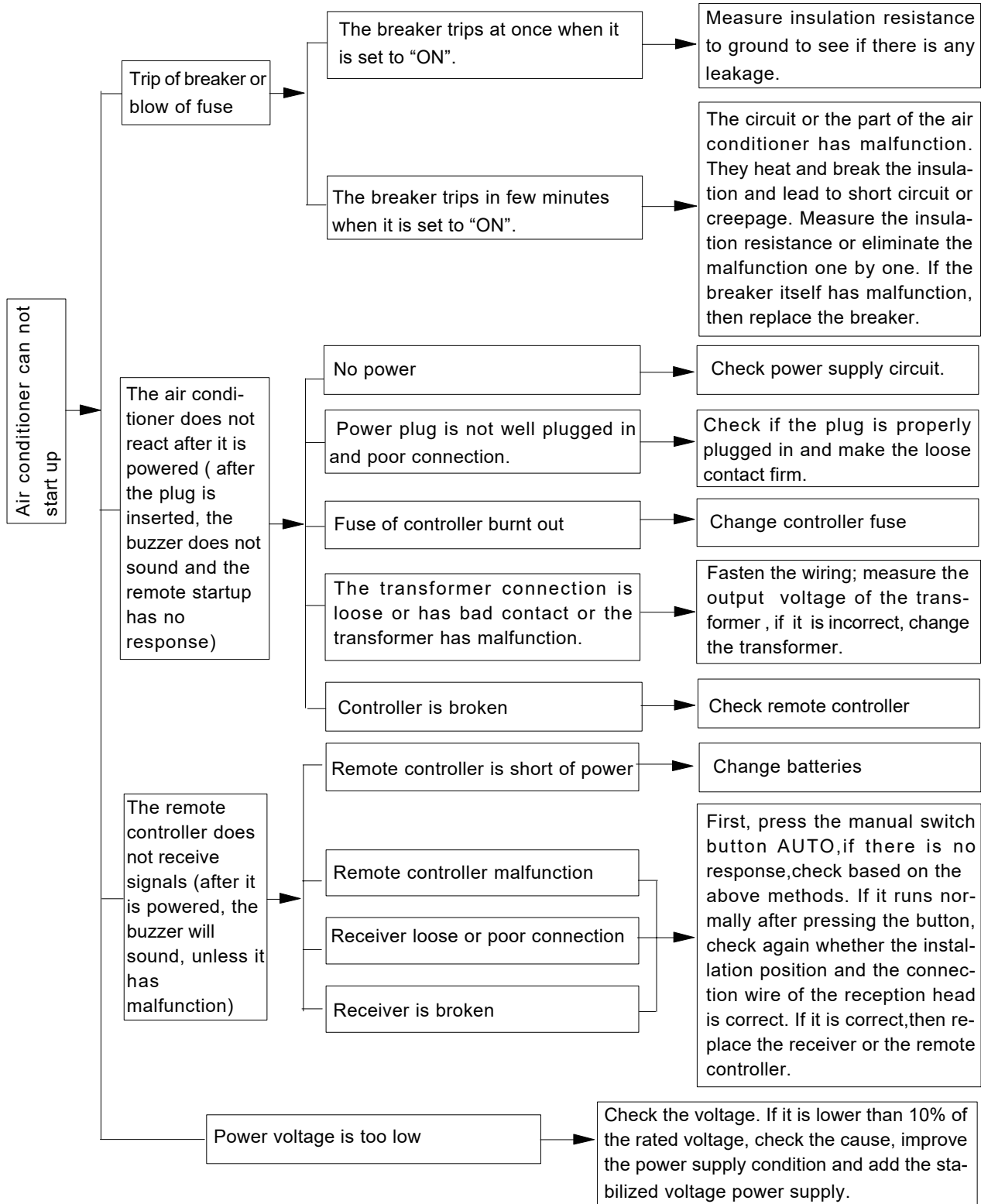

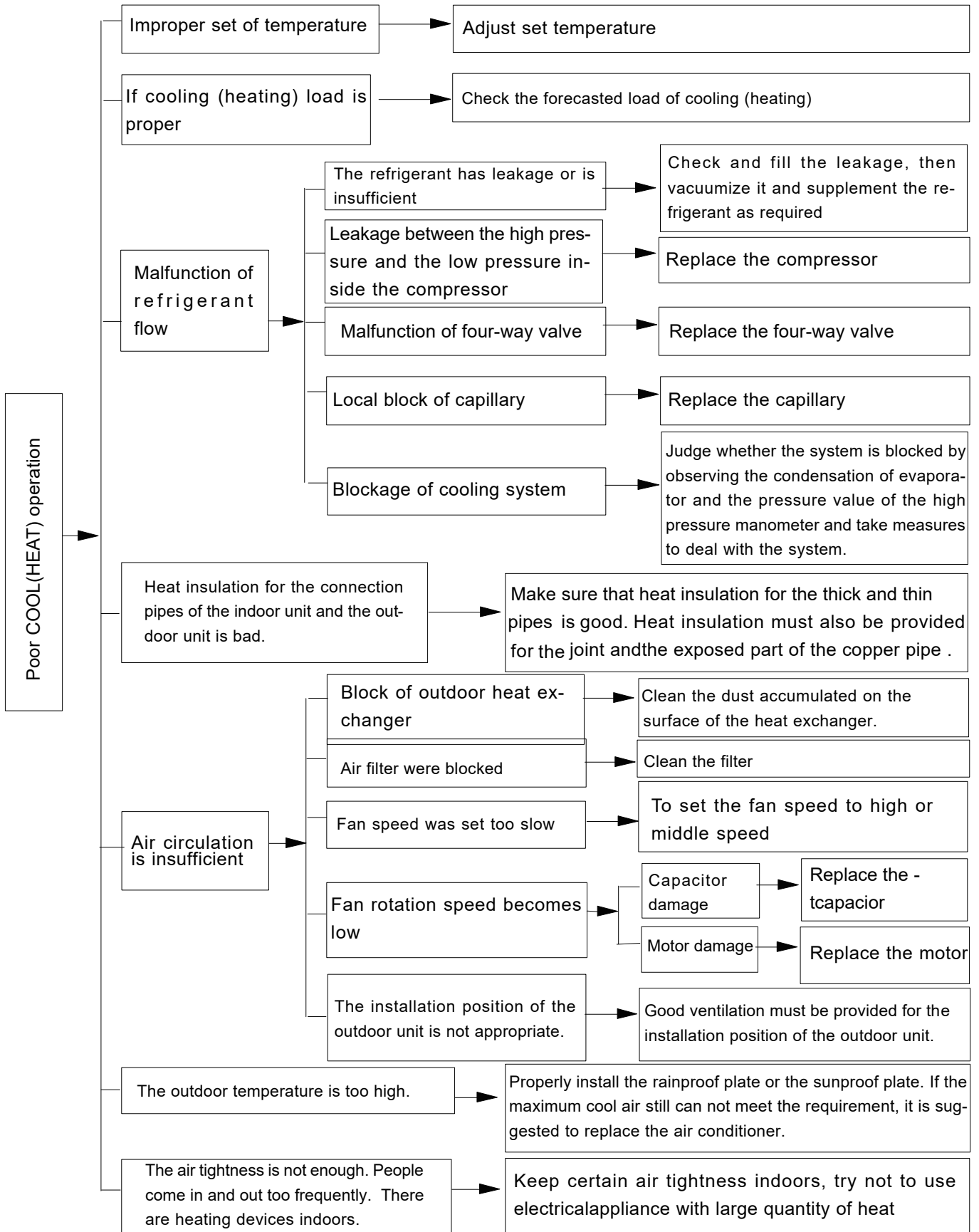

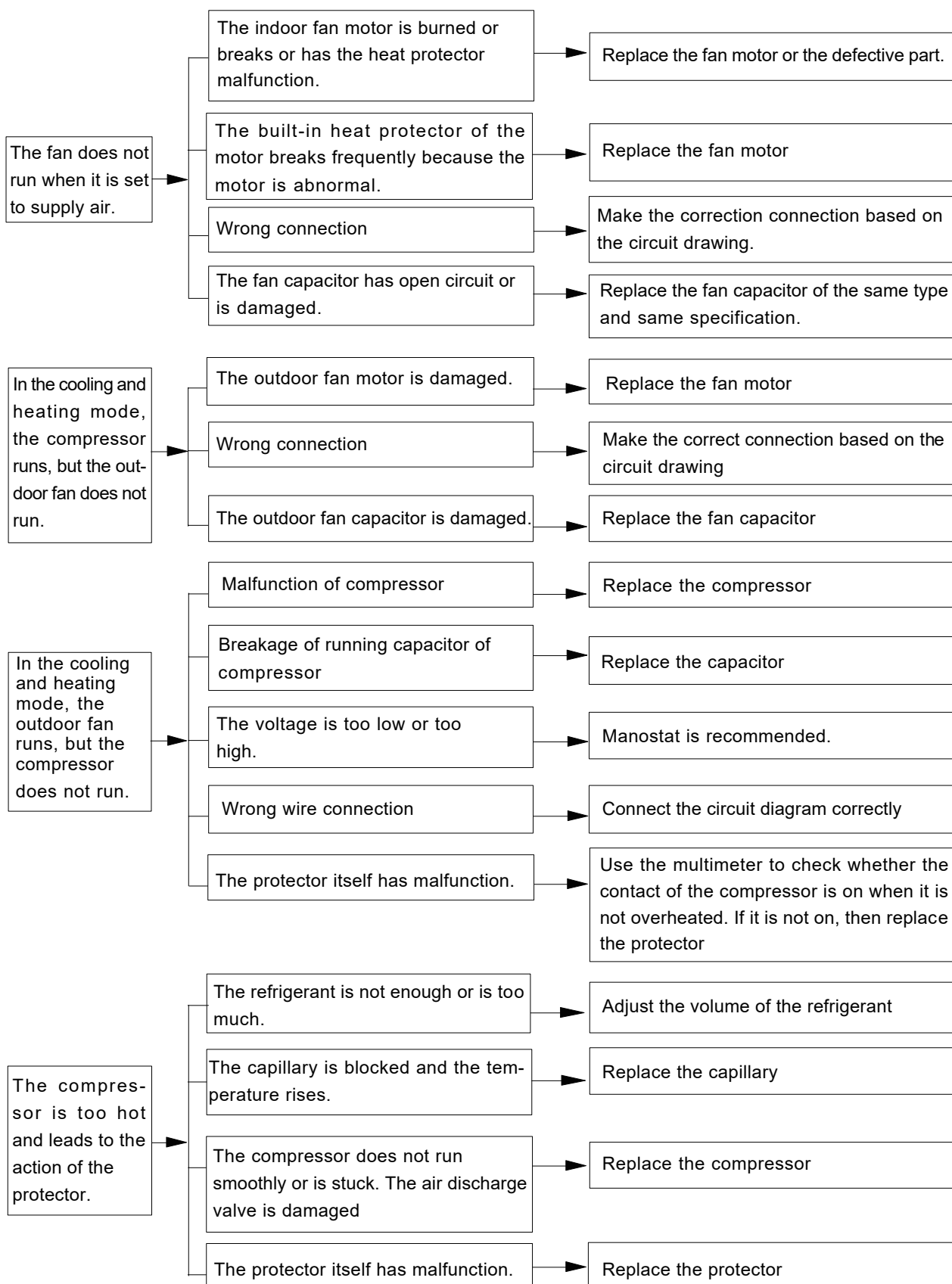

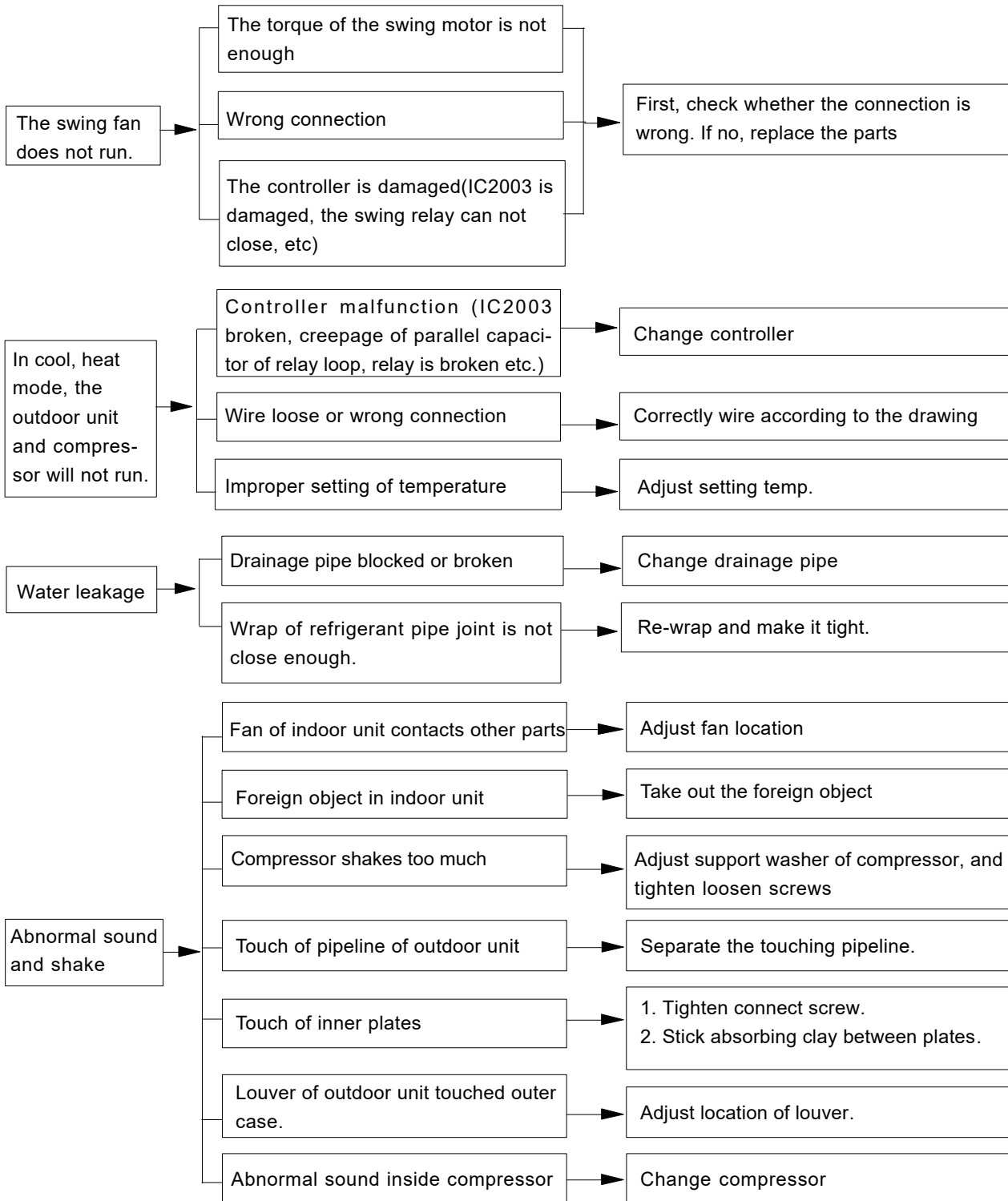

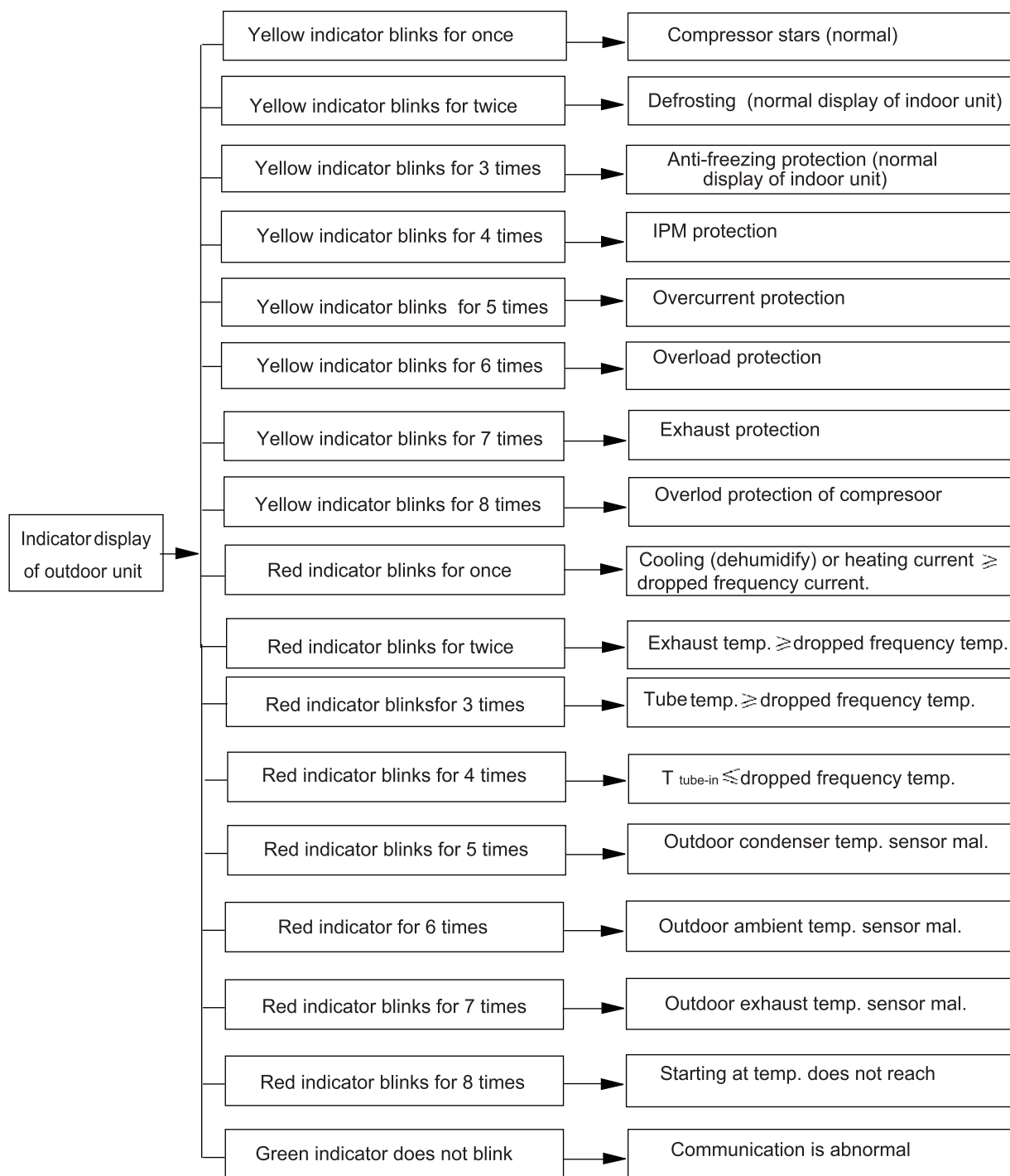

9.2 Flashing LED of Indoor/Outdoor Unit and Primary Judgement

No.	Malfunction Name	Display Method of Indoor Unit				Display Method of Outdoor Unit			A/C Status	Possible Causes
		Dual-8 Code Display	Indicator Display (during blinking, ON 0.5s and OFF 0.5s)			Indicator has 3 kinds of display status and during blinking, ON 0.5s and OFF 0.5s				
			Operation Indicator	Cool Indicator	Heat Indicator	Yellow Indicator	Red Indicator	Green Indicator		
1	High pressure protection of system	E1	OFF 3s and blink once						During cooling and drying operation, except indoor fan operates, all loads stop operation. During heating operation, the complete unit stops.	Possible reasons: 1. Refrigerant was superabundant; 2. Poor heat exchange (including exchanger and bad radiating environment); Ambient temperature is too high.
2	Antifreezing protection	E2	OFF 3S and blink twice			OFF 1S and blink 3 times			During cooling and drying operation, compressor and outdoor fan stop while indoor fan operates.	1. Poor air-return in indoor unit; 2. Fan speed is abnormal; 3. Evaporator is dirty.
3	System block or refrigerant leakage	E3	OFF 3S and blink 3 times				OFF 1S and blink 9 times		The Dual-8 Code Display will show E3 until the low pressure switch stop operation.	1.Low-pressure protection 2.Low-pressure protection of system 3.Low-pressure protection of compressor
4	High discharge temperature protection of compressor	E4	OFF 3S and blink 4 times			OFF 1S and blink 7 times			During cooling and drying operation, compressor and outdoor fan stop while indoor fan operates. During heating operation, all loads stop.	Please refer to the malfunction analysis (discharge protection, overload).
5	Overcurrent protection	E5	OFF 3S and blink 5 times			OFF 1S and blink 5 times			During cooling and drying operation, compressor and outdoor fan stop while indoor fan operates. During heating operation, all loads stop.	1. Supply voltage is unstable; 2. Supply voltage is too low and load is too high; 3. Evaporator is dirty.
6	Communication Malfunction	E6	OFF 3S and blink 6 times					OFF	During cooling operation,compressor stops while indoor fan motor operates. During heating operation, the complete unit stops.	Refer to the corresponding malfunction analysis.

No.	Malfunction Name	Display Method of Indoor Unit			Display Method of Outdoor Unit			A/C Status	Possible Causes	
		Dual-8 Code Display	Indicator Display (during blinking, ON 0.5s and OFF 0.5s)			Indicator has 3 kinds of display status and during blinking, ON 0.5s and OFF 0.5s				
			Operation Indicator	Cool Indicator	Heat Indicator	Yellow Indicator	Red Indicator			Green Indicator
7	Normal communication							continuously		
8	High temperature resistant protection	E8	OFF 3S and blink 8 times				OFF 1S and blink 6 times		During cooling operation: compressor will stop while indoor fan will operate. During heating operation, the complete unit stops.	Refer to the malfunction analysis (overload, high temperature resistant).
9	EEPROM malfunction	EE			OFF 3S and blink 15 times		OFF 1S and blink 11 times		During cooling and drying operation, compressor will stop while indoor fan will operate; During heating operation, the complete unit will stop	Replace outdoor control panel AP1
10	Limit/ decrease frequency due to high temperature of module	EU		OFF 3S and blink 6 times	OFF 3S and blink 6 times				All loads operate normally, while operation frequency for compressor is decreased	Discharging after the complete unit is de-energized for 20mins, check whether the thermal grease on IPM Module of outdoor control panel AP1 is suf and whether the radiator is inserted tightly. If its no use, please replace control panel AP1.
11	Malfunction protection of jumper cap	C5	OFF 3S and blink 15 times						Wireless remote receiver and button are effective, but can not dispose the related command	1. No jumper cap insert on mainboard. 2. Incorrect insert of jumper cap. 3. Jumper cap damaged. 4. Abnormal detecting circuit of mainboard.
12	Gathering refrigerant	Fo	OFF 3S and blink 1 times	OFF 3S and blink 1 times					When the outdoor unit receive signal of Gathering refrigerant ,the system will be forced to run under cooling mode for gathering refrigerant	Nominal cooling mode

No.	Malfunction Name	Display Method of Indoor Unit			Display Method of Outdoor Unit			A/C Status	Possible Causes	
		Dual-8 Code Display	Indicator Display (during blinking, ON 0.5s and OFF 0.5s)			Indicator has 3 kinds of display status and during blinking, ON 0.5s and OFF 0.5s				
			Operation Indicator	Cool Indicator	Heat Indicator	Yellow Indicator	Red Indicator			Green Indicator
13	Indoor ambient temperature sensor is open/short circuited	F1		OFF 3S and blink once				During cooling and drying operation, indoor unit operates while other loads will stop; during heating operation, the complete unit will stop operation.	1. Loosening or bad contact of indoor ambient temp. sensor and mainboard terminal. 2. Components in mainboard fell down leads short circuit. 3. Indoor ambient temp. sensor damaged.(check with sensor resistance value chart) 4. Mainboard damaged.	
14	Indoor evaporator temperature sensor is open/short circuited	F2		OFF 3S and blink twice				AC stops operation once reaches the setting temperature. Cooling, drying: internal fan motor stops operation while other loads stop operation; heating: AC stop operation	1. Loosening or bad contact of Indoor evaporator temp. sensor and mainboard terminal. 2. Components on the mainboard fall down leads short circuit. 3. Indoor evaporator temp. sensor damaged.(check temp. sensor value chart for testing) 4. Mainboard damaged.	
15	Outdoor ambient temperature sensor is open/short circuited	F3		OFF 3S and blink 3 times			OFF 1S and blink 6 times	During cooling and drying operating, compressor stops while indoor fan operates; During heating operation, the complete unit will stop operation	Outdoor temperature sensor hasnt been connected well or is damaged. Please check it by referring to the resistance table for temperature sensor)	

No.	Malfunction Name	Display Method of Indoor Unit			Display Method of Outdoor Unit			A/C Status	Possible Causes	
		Dual-8 Code Display	Indicator Display (during blinking, ON 0.5s and OFF 0.5s)			Indicator has 3 kinds of display status and during blinking, ON 0.5s and OFF 0.5s				
			Operation Indicator	Cool Indicator	Heat Indicator	Yellow Indicator	Red Indicator			Green Indicator
16	Outdoor condenser temperature sensor is open/short circuited	F4		OFF 3S and blink 4 times				OFF 1S and blink 5 times	During cooling and drying operation, compressor stops while indoor fan will operate; During heating operation, the complete unit will stop operation.	Outdoor temperature sensor hasn't been connected well or is damaged. Please check it by referring to the resistance table for temperature sensor)
17	Outdoor discharge temperature sensor is open/short circuited	F5		OFF 3S and blink 5 times				OFF 1S and blink 7 times	During cooling and drying operation, compressor will stop after operating for about 3 mins, while indoor fan will operate; During heating operation, the complete unit will stop after operating for about 3 mins.	1. Outdoor temperature sensor hasn't been connected well or is damaged. Please check it by referring to the resistance table for temperature sensor) 2. The head of temperature sensor hasn't been inserted into the copper tube
18	Limit/decrease frequency due to overload	F6		OFF 3S and blink for 6 times				OFF 1S and blink 3 times	All loads operate normally, while operation frequency for compressor is decreased	Refer to the malfunction analysis (overload, high temperature resistant)
19	Decrease frequency due to overcurrent	F8		OFF 3S and blink 8 times				OFF 1S and blink once	All loads operate normally, while operation frequency for compressor is decreased	The input supply voltage is too low; System pressure is too high and overload
20	Decrease frequency due to high air discharge	F9		OFF 3S and blink 9 times				OFF 1S and blink twice	All loads operate normally, while operation frequency for compressor is decreased	Overload or temperature is too high; Refrigerant Malfunction of electric expansion valve (EKV)
21	Limit/decrease frequency due to antifreezing	FH		OFF 3S and blink 2 times	OFF 3S and blink 2 times			OFF 1S and blink 4 times	All loads operate normally, while operation frequency for compressor is decreased	Poor air-return in indoor unit or fan speed is too low

No.	Malfunction Name	Display Method of Indoor Unit			Display Method of Outdoor Unit			A/C Status	Possible Causes	
		Dual-8 Code Display	Indicator Display (during blinking, ON 0.5s and OFF 0.5s)			Indicator has 3 kinds of display status and during blinking, ON 0.5s and OFF 0.5s				
			Operation Indicator	Cool Indicator	Heat Indicator	Yellow Indicator	Red Indicator			Green Indicator
22	Voltage for DC bus-bar is too high	PH		OFF 3S and blink 11 times			OFF 1S and blink 13 times			<p>During cooling and drying operation, compressor will stop while indoor fan will operate; During heating operation, the complete unit will stop operation.</p> <p>1. Measure the voltage of position L and N on wiring board (XT), if the voltage is higher than 265VAC, turn on the unit after the supply voltage is increased to the normal range. 2. If the AC input is normal, measure the voltage of electrolytic capacitor C on control panel (AP1), if its normal, there's malfunction for the circuit, please replace the control panel (AP1)</p>
23	Voltage of DC bus-bar is too low	PL			OFF 3S and blink 21 times		OFF 1S and blink 12 times			<p>During cooling and drying operation, compressor will stop while indoor fan will operate; During heating operation, the complete unit will stop</p> <p>1. Measure the voltage of position L and N on wiring board (XT), if the voltage is higher than 150VAC, turn on the unit after the supply voltage is increased to the normal range. 2. If the AC input is normal, measure the voltage of electrolytic capacitor C on control panel (AP1), if its normal, there's malfunction for the circuit, please replace the control panel (AP1)</p>
24	Compressor Min frequency in test state	P0		(during blinking, ON 0.25s and OFF 0.25s)	(during blinking, ON 0.25s and OFF 0.25s)					Showing during min. cooling or min. heating test

No.	Malfunction Name	Display Method of Indoor Unit			Display Method of Outdoor Unit			A/C Status	Possible Causes	
		Dual-8 Code Display	Indicator Display (during blinking, ON 0.5s and OFF 0.5s)			Indicator has 3 kinds of display status and during blinking, ON 0.5s and OFF 0.5s				
			Operation Indicator	Cool Indicator	Heat Indicator	Yellow Indicator	Red Indicator			Green Indicator
25	Compressor rated frequency in test state	P1		(during blinking, ON 0.25s and OFF 0.25s)	(during blinking, ON 0.25s and OFF 0.25s)				Showing during nominal cooling or nominal heating test	
26	Compressor maximum frequency in test state	P2		(during blinking, ON 0.25s and OFF 0.25s)	(during blinking, ON 0.25s and OFF 0.25s)				Showing during max. cooling or max. heating test	
27	Compressor intermediate frequency in test state	P3		(during blinking, ON 0.25s and OFF 0.25s)	(during blinking, ON 0.25s and OFF 0.25s)				Showing during middle cooling or middle heating test	
28	Overcurrent protection of phase current for compressor	P5		OFF 3S and blink 15 times				During cooling and drying operation, compressor will stop while indoor fan will operate; During heating operation, the complete unit will stop operation.	Refer to the malfunction analysis (IPM protection, loss of synchronism protection and overcurrent protection of phase current for compressor.	
29	Charging malfunction of capacitor	PU		OFF 3S and blink 17 times				During cooling and drying operation, compressor will stop while indoor fan will operate; During heating operation, the complete unit will stop	Refer to the part three—charging malfunction analysis of capacitor	
30	Malfunction of module temperature sensor circuit	P7			OFF 3S and blink 18 times			During cooling and drying operation, compressor will stop while indoor fan will operate; During heating operation, the complete unit will stop	Replace outdoor control panel AP1	

No.	Malfunction Name	Display Method of Indoor Unit			Display Method of Outdoor Unit			A/C Status	Possible Causes	
		Dual-8 Code Display	Indicator Display (during blinking, ON 0.5s and OFF 0.5s)			Indicator has 3 kinds of display status and during blinking, ON 0.5s and OFF 0.5s				
			Operation Indicator	Cool Indicator	Heat Indicator	Yellow Indicator	Red Indicator			Green Indicator
31	Module high temperature protection	P8			OFF 3S and blink 19 times				During cooling operation, compressor will stop while indoor fan will operate; During heating operation, the complete unit will stop	After the complete unit is deenergized for 20mins, check whether the thermal grease on IPM Module of outdoor control panel whether the radiator is inserted tightly. If its no use, please replace control panel AP1.
32	Decrease frequency due to high temperature resistant during heating operation	HO			OFF 3S and blink 10 times				All loads operate normally, while operation frequency for compressor is decreased	Refer to the malfunction analysis (overload, high temperature resistant)
33	Static dedusting protection	H2			OFF 3S and blink twice					
34	Overload protection for compressor	H3			OFF 3S and blink 3 times	OFF 1S and blink 8 times			During cooling and drying operation, compressor will stop while indoor fan will operate; During heating operation, the complete unit will stop operation.	1. Wiring terminal OVC-COMP is loosened. In normal state, the resistance for this terminal should be less than 1ohm. 2. Refer to the malfunction analysis (discharge protection, overload)
35	System is abnormal	H4			OFF 3S and blink 4 times	OFF 1S and blink 6 times			During cooling and drying operation, compressor will stop while indoor fan will operate; During heating operation, the complete unit will stop operation	Refer to the malfunction analysis (overload, high temperature resistant)

No.	Malfunction Name	Display Method of Indoor Unit			Display Method of Outdoor Unit			A/C Status	Possible Causes	
		Dual-8 Code Display	Indicator Display (during blinking, ON 0.5s and OFF 0.5s)			Indicator has 3 kinds of display status and during blinking, ON 0.5s and OFF 0.5s				
			Operation Indicator	Cool Indicator	Heat Indicator	Yellow Indicator	Red Indicator			Green Indicator
36	IPM protection	H5			OFF 3S and blink 5 times	OFF 1S and blink 4 times			During cooling and drying operation, compressor will stop while indoor fan will operate; During heating operation, the complete unit will stop operation.	Refer to the malfunction analysis (IPM protection, loss of synchronism protection and overcurrent protection of phase current for compressor.
37	Module temperature is too high	H5			OFF 3S and blink 5 times	OFF 1S and blink 10 times				
38	Internal motor (fan motor) do not operate	H6	OFF 3S and blink 11 times						Internal fan motor, external fan motor, compressor and electric heater stop operation, guide louver stops at present location.	1. Bad contact of DC motor feedback terminal. 2. Bad contact of DC motor control end. 3. Fan motor is stalling. 4. Motor malfunction. 5. Malfunction of mainboard rev detecting circuit.
39	Desynchronizing of compressor	H7			OFF 3S and blink 7 times				During cooling and drying operation, compressor will stop while indoor fan will operate; During heating operation, the complete unit will stop operation.	Refer to the malfunction analysis (IPM protection, loss of synchronism protection and overcurrent protection of phase current for compressor.
40	PFC protection	HC			OFF 3S and blink 6 times	OFF 1S and blink 14 times			During cooling and drying operation, compressor will stop while indoor fan will operate; During heating operation, the complete unit will stop operation.	Refer to the malfunction analysis

No.	Malfunction Name	Display Method of Indoor Unit			Display Method of Outdoor Unit			A/C Status	Possible Causes	
		Dual-8 Code Display	Indicator Display (during blinking, ON 0.5s and OFF 0.5s)			Indicator has 3 kinds of display status and during blinking, ON 0.5s and OFF 0.5s				
			Operation Indicator	Cool Indicator	Heat Indicator	Yellow Indicator	Red Indicator			Green Indicator
41	Outdoor DC fan motor malfunction	L3	OFF 3S and blink 23 times				OFF 1S and blink 14 times		Outdoor DC fan motor malfunction lead to compressor stop operation, DC fan motor malfunction or system blocked or the connector loosed	
42	power protection	L9	OFF 3S and blink 20 times				OFF 1S and blink 9 times		compressor stop operation and Outdoor fan motor will stop 30s latter , 3 minutes latter fan motor and compressor will restart To protect the electronical components when detect high power	
43	Indoor unit and outdoor unit doesn't match	LP	OFF 3S and blink 19 times				OFF 1S and blink 16 times		compressor and Outdoor fan motor can't work Indoor unit and outdoor unit doesn't match	
44	Failure startup	LC			OFF 3S and blink 11 times				During cooling and drying operation, compressor will stop while indoor fan will operate; During heating operation, the complete unit will stop operation. Refer to the malfunction analysis	
45	Malfunction of phase current detection circuit for compressor	U1			OFF 3S and blink 13 times				During cooling and drying operation, compressor will stop while indoor fan will operate; During heating operation, the complete unit will stop Replace outdoor control panel AP1	
46	Malfunction of voltage dropping for DC bus-bar	U3			OFF 3S and blink 20 times				During cooling and drying operation, compressor will stop while indoor fan will operate; During heating operation, the complete unit will stop Supply voltage is unstable	
47	Malfunction of complete units current detection	U5		OFF 3S and blink 13 times					During cooling and drying operation, the compressor will stop while indoor fan will operate; During heating operating, the complete unit will stop operation. Theres circuit malfunction on outdoor units control panel AP1, please replace the outdoor units control panel AP1.	

No.	Malfunction Name	Display Method of Indoor Unit				Display Method of Outdoor Unit			A/C Status	Possible Causes	
		Dual-8 Code Display	Indicator Display (during blinking, ON 0.5s and OFF 0.5s)			Indicator has 3 kinds of display status and during blinking, ON 0.5s and OFF 0.5s					
			Operation Indicator	Cool Indicator	Heat Indicator	Yellow Indicator	Red Indicator	Green Indicator			
48	The four-way valve is abnormal	U7	OFF 3S and blink 20 times							If this malfunction occurs during heating operation, the complete unit will stop operation.	1. Supply voltage is lower than AC175V; 2. Wiring terminal 4V is loosened or broken; 3. 4V is damaged, please replace 4V.
49	Zerocrossing malfunction of outdoor unit	U9	OFF 3S and blink 18 times							During cooling operation, compressor will stop while indoor fan will operate; during heating, the complete unit will stop operation.	Replace outdoor control panel AP1
50	Frequency limiting (power)						OFF 1S and blink 13 times				
51	Compressor is opencircuited					OFF 1S and blink once					
52	The temperature for turning on the unit is reached						OFF 1S and blink 8 times				
53	Frequency limiting (module temperature)						OFF 1S and blink 11 times				
54	Defrosting				OFF 3S and blink once (during blinking, ON 10s and OFF 0.5s)	OFF 1S and blink twice				Defrosting will occur in heating mode. Compressor will operate while indoor fan will stop operation.	Its the normal state

NO.	Description	Part Code	Qty
		AWWR-WFD012-C11	
Product Code		7WT010009	
1	Cabinet Assy	0000600003	1
2	Condenser Assy	01100200518	1
3	Discharge Tube Sub-assy	03001300361	1
4	Rear Cover Plate	22241017	1
5	Rear Clapboard	20051030	1
6	Axial Flow Fan	10331162	1
7	Fan Motor	1501106106	1
8	Connected Board(front & back)	01207700003	1
9	Motor Support	01701032	1
10	Front Clapboard Sub-Assy	01700200002	1
11	Foam(Propeller Housing)	12311050	1
12	Top Cover Board Sub-assy	01701100004	1
13	Connected Board(Propeller Housing)	01207700004	2
14	Centrifugal Fan	10311016	1
15	Air Louver	10511041	1
16	Crank	73011006	1
17	SteppingMotor	15212116	1
18	Air door support	24211039	1
19	Air Outlet Sub-Assy	20903100002	1
20	Evaporator Assy	01100100253	1
21	Clapboard	01205100003	1
22	Compressor and Fittings	00101415	1
23	Compressor Gasket	76710287	3
24	Capillary Sub-assy	03000600493	1
25	Drainage hole Cap	76711012	1
26	Inhalation Tube Sub-assy	03001000373	1
27	Chassis Sub-assy	01700000159P	1
28	Foam (Water Tray)	12311658	1
29	Chassis Clamp	01211601	1
30	Wire Clamp	71010103	1
31	Electric Box Assy 1	10000100730	1
32	Seat Board Sub-Assy	01708000004	1
33	Capacitor CBB61S	3301074714	1
34	Electric Box	01201700098	1
35	Terminal Board	42011103	1
36	Electric Box Assy	10000202695	1
37	LCD Cover Sub-assy	00018900010	1
38	LCD Board(Remote Control)	20121318	1
39	Membrane	22431132	1
40	Power Cord	4002046442	1
41	Remote Controller	30510065	1
42	Guide Blade	105116021	14
43	Guide Blade Lever	10581604	1
44	Front Case	20001601	1
45	Filter Sub-Assy	11121601	1
46	Air Intake Panel	20001602	1
47	Front Panel Assy	20001801	1

Above data is subject to change without notice.

11. Removal Procedure

 Caution: pull out the power, discharge the refrigerant completely before removal.

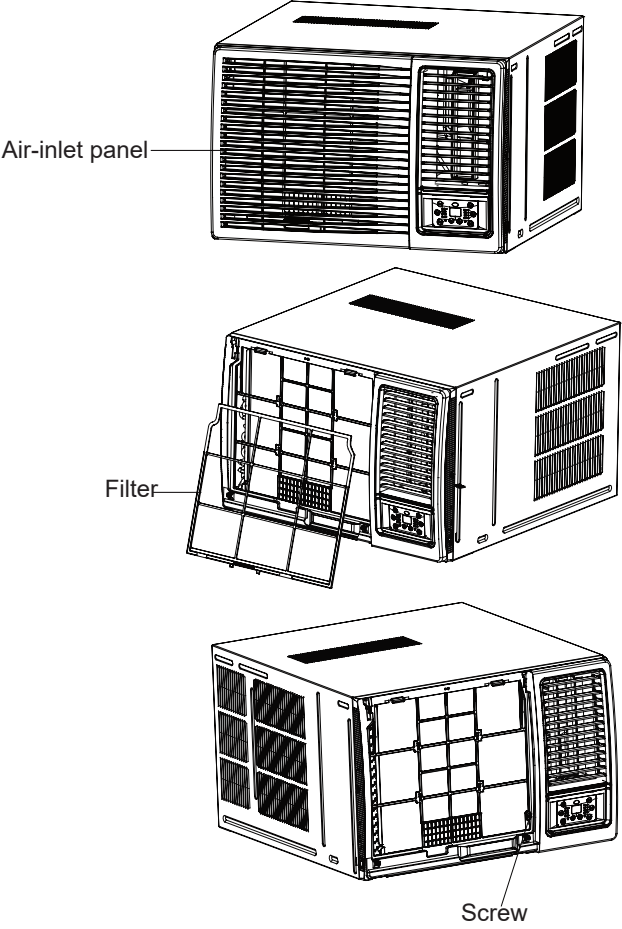
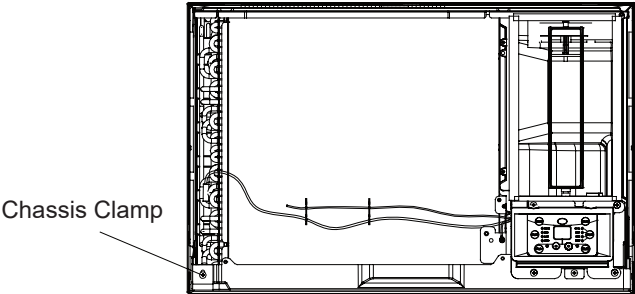
Step	Procedure
<p>1. Remove panel assy</p>	<p>Open the air-inlet panel; remove the [panel] at the left side and right side of the panel; beat the clasp of cabinet slightly and then remove the panel.</p> 
<p>2. Remove cabinet</p>	<p>and then pull out the unit.</p> 

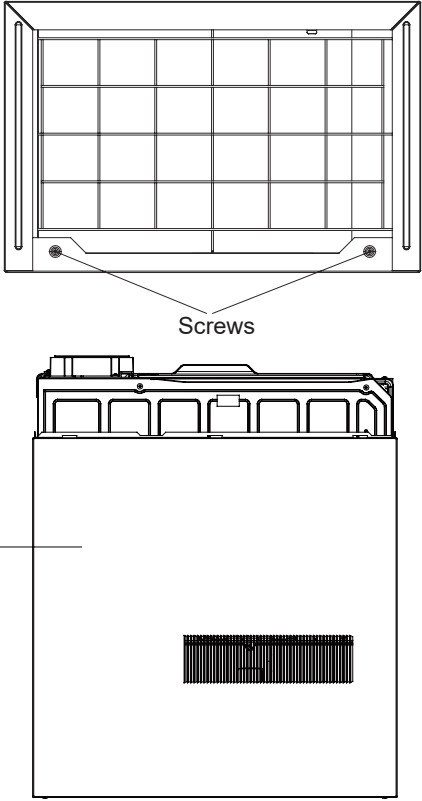
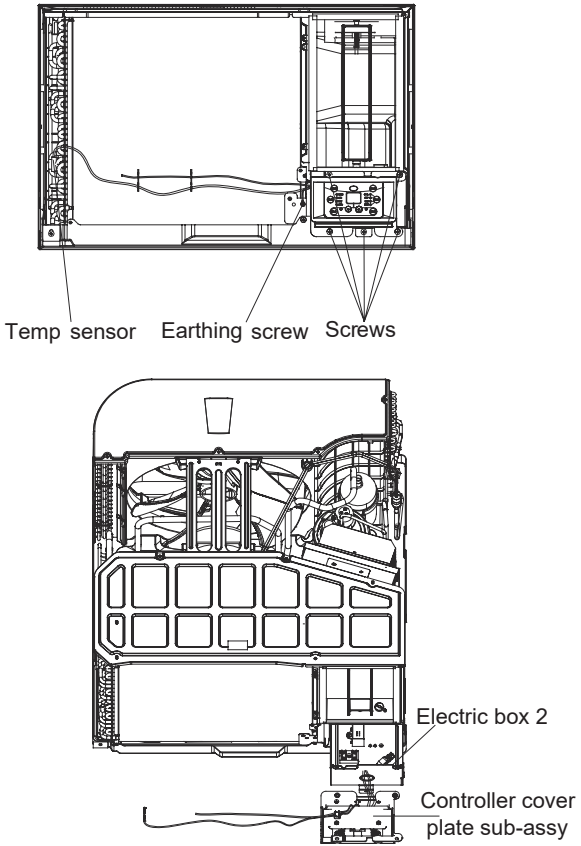
Step	Procedure	
		 <p style="text-align: center;">Screws</p> <p style="text-align: center;">Cabinet</p>
<p>3. Remove electric box 2</p>	<p>Remove remote control plate, earthing screw and temp sensor in turn. Then remove electric box 2 and controller cover plate sub-assy.</p>	 <p style="text-align: center;">Temp sensor Earthing screw Screws</p> <p style="text-align: right;">Electric box 2 Controller cover plate sub-assy</p>

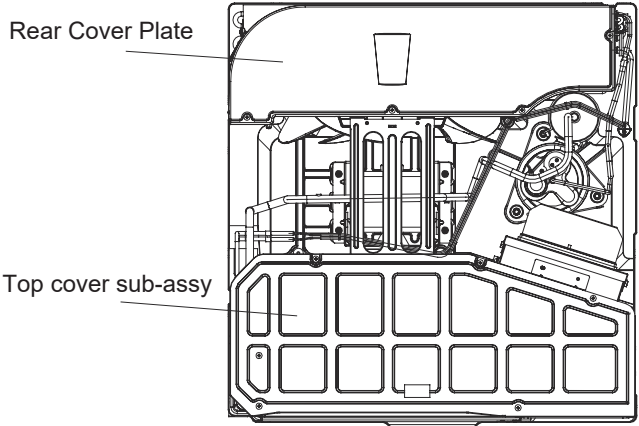
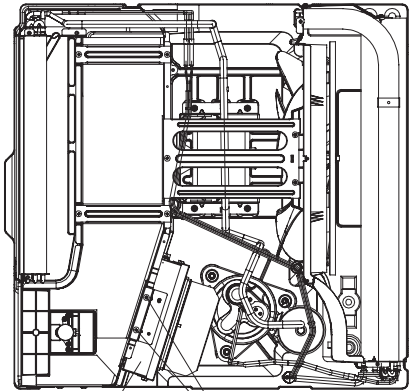
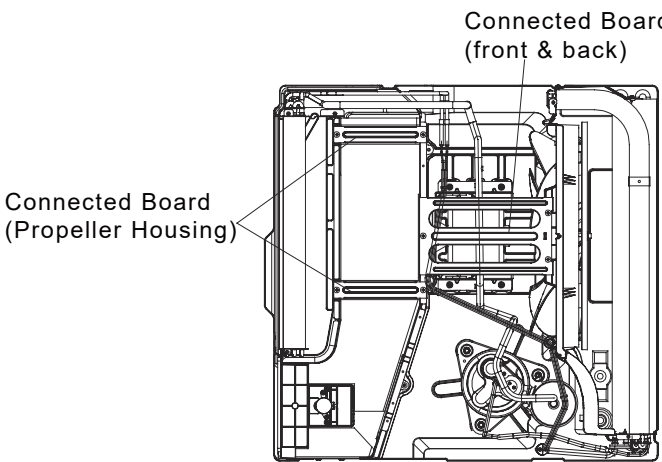
Step	Procedure	
4. Remove top cover sub-assy and rear cover plate	<p>plate and then remove the upper cover</p> <p>remove the rear cover plate.</p>	 <p>Rear Cover Plate</p> <p>Top cover sub-assy</p>
5. Remove electric box 1	<p>Twist of out compressor wires and overload wires, remove wires of ambient temperature sensor, external tube temperature sensor and discharge temperature sensor, and then pull the electric upwards to remove it.</p>	 <p>Electric box 1 Screws</p>
6.Remove connected board(propeller housing), connected board(front & back)	<p>Remove screws fixing connection board of propeller housing and front and rear connection board, and then remove the connection board (front & back) of propeller housing and front and rear connection board.</p>	 <p>Connected Board (Propeller Housing)</p> <p>Connected Board (front & back)</p>

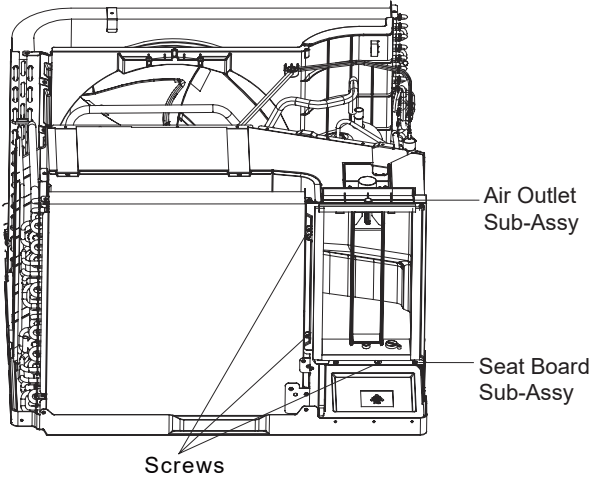
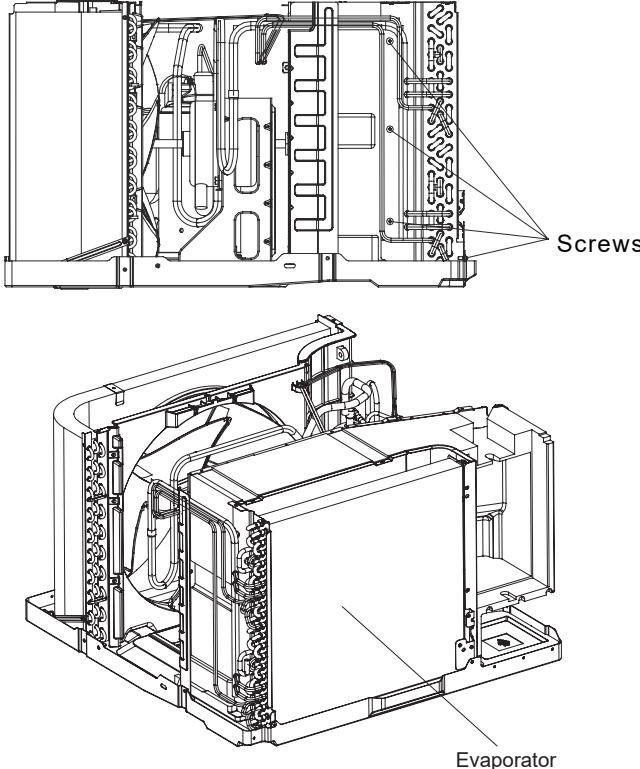
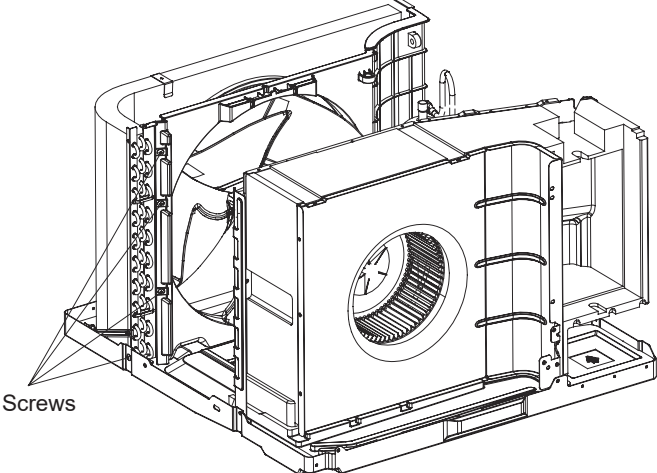
Step	Procedure	
7. Remove Air Outlet Sub-Assy and Seat Board Sub-Assy	<p>sub-assy, and then draw out air outlet sub-assy and seat board of air duct.</p>	
8. Remove evaporator	<p>Unsolder each connection pipe (Note: discharge the refrigerant completely before unsoldering). and then remove the evaporator.</p>	
9. Remove condenser	<p>Unsolder each connection pipe (Note: discharge the refrigerant completely before unsoldering). and then remove the condenser.</p>	

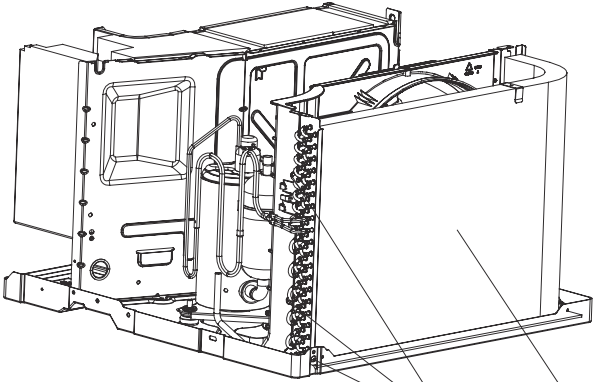
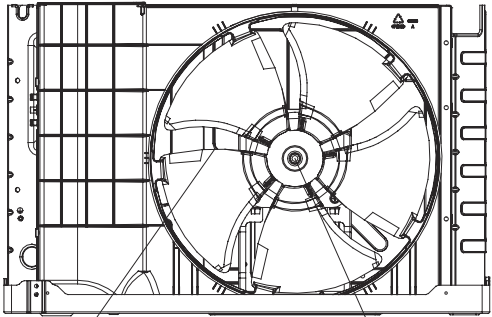
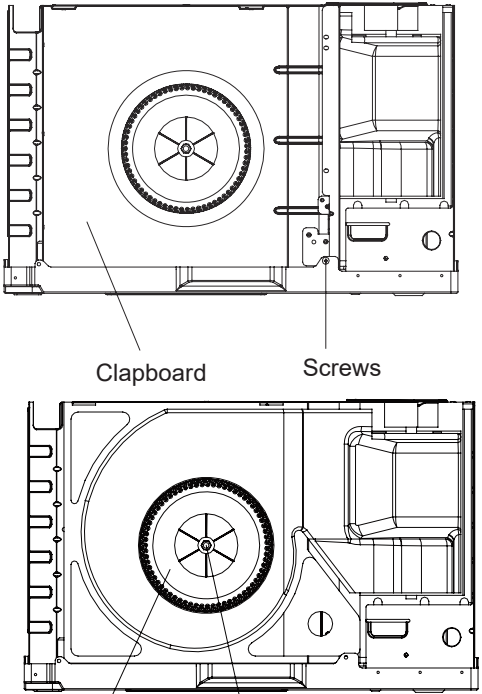
Step	Procedure	
		 <p>Screws Condenser</p>
	<p>remove the washer and then remove</p>	 <p>Axial flow blad Nut</p>
<p>11. Remove Clapboard and Centrifugal Fan</p>		
	<p>sheet, and then draw out the isolation sheet; Remove the nuts of centrifugal blade with wrench, take out the washer and then remove the centrifugal blade.</p>	 <p>Clapboard Screws</p> <p>Centrifugal blade Nut</p>

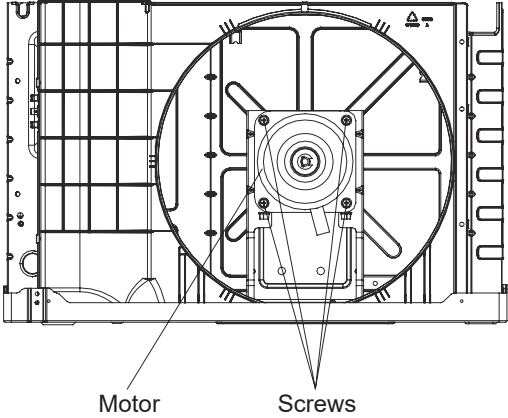
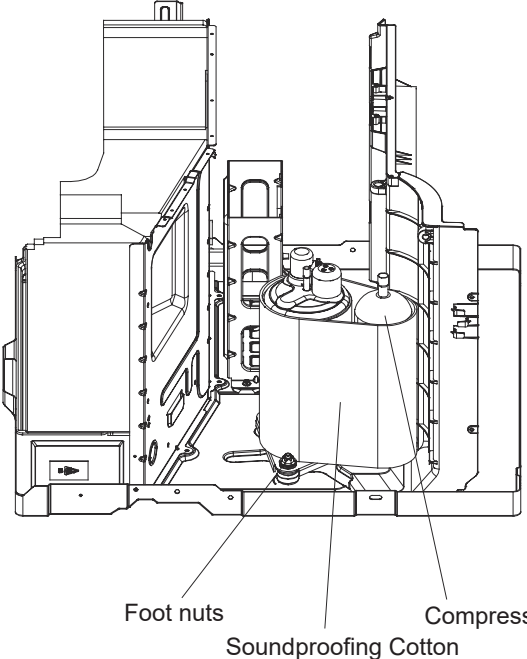
Step	Procedure
12. Remove motor	<p>Remove the screws of motor support; take out the motor support; remove the screws of motor and then remove the motor.</p>  <p>The diagram shows a top-down view of the motor assembly. A central circular motor is mounted on a rectangular support frame. Several screws are shown securing the support frame to the motor. Labels 'Motor' and 'Screws' point to their respective parts.</p>
13. Remove compressor	<p>Unsolder each connection pipe (Note: discharge the refrigerant completely before unsoldering). Remove the foot compressor and then remove the compressor.</p>  <p>The diagram shows a side view of the compressor assembly. A cylindrical compressor is mounted on a base. A foot nut is visible at the bottom of the base. Soundproofing cotton is shown surrounding the compressor. Labels 'Foot nuts', 'Soundproofing Cotton', and 'Compressor' point to their respective parts.</p>

Appendix:

Appendix 1: Reference Sheet of Celsius and Fahrenheit

Conversion formula for Fahrenheit degree and Celsius degree: $T_f = T_c \times 1.8 + 32$

Set temperature

Fahrenheit display temperature (°F)	Fahrenheit (°F)	Celsius(°C)	Fahrenheit display temperature (°F)	Fahrenheit (°F)	Celsius (°C)	Fahrenheit display temperature (°F)	Fahrenheit (°F)	Celsius (°C)
61	60.8	16	69/70	69.8	21	78/79	78.8	26
62/63	62.6	17	71/72	71.6	22	80/81	80.6	27
64/65	64.4	18	73/74	73.4	23	82/83	82.4	28
66/67	66.2	19	75/76	75.2	24	84/85	84.2	29
68	68	20	77	77	25	86	86	30

Ambient temperature

Fahrenheit display temperature (°F)	Fahrenheit (°F)	Celsius(°C)	Fahrenheit display temperature (°F)	Fahrenheit (°F)	Celsius(°C)	Fahrenheit display temperature (°F)	Fahrenheit (°F)	Celsius(°C)
32/33	32	0	55/56	55.4	13	79/80	78.8	26
34/35	33.8	1	57/58	57.2	14	81	80.6	27
36	35.6	2	59/60	59	15	82/83	82.4	28
37/38	37.4	3	61/62	60.8	16	84/85	84.2	29
39/40	39.2	4	63	62.6	17	86/87	86	30
41/42	41	5	64/65	64.4	18	88/89	87.8	31
43/44	42.8	6	66/67	66.2	19	90	89.6	32
45	44.6	7	68/69	68	20	91/92	91.4	33
46/47	46.4	8	70/71	69.8	21	93/94	93.2	34
48/49	48.2	9	72	71.6	22	95/96	95	35
50/51	50	10	73/74	73.4	23	97/98	96.8	36
52/53	51.8	11	75/76	75.2	24	99	98.6	37
54	53.6	12	77/78	77	25			

Appendix 2: List of Resistance for Ambient Temperature Sensor

Resistance Table of Ambient Temperature Sensor (15K)

Temp(°C)	Resistance(kΩ)	Temp(°C)	Resistance(kΩ)	Temp(°C)	Resistance(kΩ)	Temp(°C)	Resistance(kΩ)
-19	138.1	20	18.75	59	3.848	98	1.071
-18	128.6	21	17.93	60	3.711	99	1.039
-17	121.6	22	17.14	61	3.579	100	1.009
-16	115	23	16.39	62	3.454	101	0.98
-15	108.7	24	15.68	63	3.333	102	0.952
-14	102.9	25	15	64	3.217	103	0.925
-13	97.4	26	14.36	65	3.105	104	0.898
-12	92.22	27	13.74	66	2.998	105	0.873
-11	87.35	28	13.16	67	2.896	106	0.848
-10	82.75	29	12.6	68	2.797	107	0.825
-9	78.43	30	12.07	69	2.702	108	0.802
-8	74.35	31	11.57	70	2.611	109	0.779
-7	70.5	32	11.09	71	2.523	110	0.758
-6	66.88	33	10.63	72	2.439	111	0.737
-5	63.46	34	10.2	73	2.358	112	0.717
-4	60.23	35	9.779	74	2.28	113	0.697
-3	57.18	36	9.382	75	2.206	114	0.678
-2	54.31	37	9.003	76	2.133	115	0.66
-1	51.59	38	8.642	77	2.064	116	0.642
0	49.02	39	8.297	78	1.997	117	0.625
1	46.6	40	7.967	79	1.933	118	0.608
2	44.31	41	7.653	80	1.871	119	0.592
3	42.14	42	7.352	81	1.811	120	0.577
4	40.09	43	7.065	82	1.754	121	0.561
5	38.15	44	6.791	83	1.699	122	0.547
6	36.32	45	6.529	84	1.645	123	0.532
7	34.58	46	6.278	85	1.594	124	0.519
8	32.94	47	6.038	86	1.544	125	0.505
9	31.38	48	5.809	87	1.497	126	0.492
10	29.9	49	5.589	88	1.451	127	0.48
11	28.51	50	5.379	89	1.408	128	0.467
12	27.18	51	5.197	90	1.363	129	0.456
13	25.92	52	4.986	91	1.322	130	0.444
14	24.73	53	4.802	92	1.282	131	0.433
15	23.6	54	4.625	93	1.244	132	0.422
16	22.53	55	4.456	94	1.207	133	0.412
17	21.51	56	4.294	95	1.171	134	0.401
18	20.54	57	4.139	96	1.136	135	0.391
19	19.63	58	3.99	97	1.103	136	0.382

Resistance Table of Ambient Temperature Sensor (20K)

Temp(°C)	Resistance(kΩ)	Temp(°C)	Resistance(kΩ)	Temp(°C)	Resistance(kΩ)	Temp(°C)	Resistance(kΩ)
-19	181.4	20	25.01	59	5.13	98	1.427
-18	171.4	21	23.9	60	4.948	99	1.386
-17	162.1	22	22.85	61	4.773	100	1.346
-16	153.3	23	21.85	62	4.605	101	1.307
-15	145	24	20.9	63	4.443	102	1.269
-14	137.2	25	20	64	4.289	103	1.233
-13	129.9	26	19.14	65	4.14	104	1.198
-12	123	27	18.13	66	3.998	105	1.164
-11	116.5	28	17.55	67	3.861	106	1.131
-10	110.3	29	16.8	68	3.729	107	1.099
-9	104.6	30	16.1	69	3.603	108	1.069
-8	99.13	31	15.43	70	3.481	109	1.039
-7	94	32	14.79	71	3.364	110	1.01
-6	89.17	33	14.18	72	3.252	111	0.983
-5	84.61	34	13.59	73	3.144	112	0.956
-4	80.31	35	13.04	74	3.04	113	0.93
-3	76.24	36	12.51	75	2.94	114	0.904
-2	72.41	37	12	76	2.844	115	0.88
-1	68.79	38	11.52	77	2.752	116	0.856
0	65.37	39	11.06	78	2.663	117	0.833
1	62.13	40	10.62	79	2.577	118	0.811
2	59.08	41	10.2	80	2.495	119	0.77
3	56.19	42	9.803	81	2.415	120	0.769
4	53.46	43	9.42	82	2.339	121	0.746
5	50.87	44	9.054	83	2.265	122	0.729
6	48.42	45	8.705	84	2.194	123	0.71
7	46.11	46	8.37	85	2.125	124	0.692
8	43.92	47	8.051	86	2.059	125	0.674
9	41.84	48	7.745	87	1.996	126	0.658
10	39.87	49	7.453	88	1.934	127	0.64
11	38.01	50	7.173	89	1.875	128	0.623
12	36.24	51	6.905	90	1.818	129	0.607
13	34.57	52	6.648	91	1.736	130	0.592
14	32.98	53	6.403	92	1.71	131	0.577
15	31.47	54	6.167	93	1.658	132	0.563
16	30.04	55	5.942	94	1.609	133	0.549
17	28.68	56	5.726	95	1.561	134	0.535
18	27.39	57	5.519	96	1.515	135	0.521
19	26.17	58	5.32	97	1.47	136	0.509

Resistance Table of Ambient Temperature Sensor (50K)

Temp(°C)	Resistance(kΩ)		Temp(°C)	Resistance(kΩ)		Temp(°C)	Resistance(kΩ)		Temp(°C)	Resistance(kΩ)
-29	853.5		10	98		49	18.34		88	4.75
-28	799.8		11	93.42		50	17.65		89	4.61
-27	750		12	89.07		51	16.99		90	4.47
-26	703.8		13	84.95		52	16.36		91	4.33
-25	660.8		14	81.05		53	15.75		92	4.20
-24	620.8		15	77.35		54	15.17		93	4.08
-23	580.6		16	73.83		55	14.62		94	3.96
-22	548.9		17	70.5		56	14.09		95	3.84
-21	516.6		18	67.34		57	13.58		96	3.73
-20	486.5		19	64.33		58	13.09		97	3.62
-19	458.3		20	61.48		59	12.62		98	3.51
-18	432		21	58.77		60	12.17		99	3.41
-17	407.4		22	56.19		61	11.74		100	3.32
-16	384.5		23	53.74		62	11.32		101	3.22
-15	362.9		24	51.41		63	10.93		102	3.13
-14	342.8		25	49.19		64	10.54		103	3.04
-13	323.9		26	47.08		65	10.18		104	2.96
-12	306.2		27	45.07		66	9.83		105	2.87
-11	289.6		28	43.16		67	9.49		106	2.79
-10	274		29	41.34		68	9.17		107	2.72
-9	259.3		30	39.61		69	8.85		108	2.64
-8	245.6		31	37.96		70	8.56		109	2.57
-7	232.6		32	36.38		71	8.27		110	2.50
-6	220.5		33	34.88		72	7.99		111	2.43
-5	209		34	33.45		73	7.73		112	2.37
-4	198.3		35	32.09		74	7.47		113	2.30
-3	199.1		36	30.79		75	7.22		114	2.24
-2	178.5		37	29.54		76	7.00		115	2.18
-1	169.5		38	28.36		77	6.76		116	2.12
0	161		39	27.23		78	6.54		117	2.07
1	153		40	26.15		79	6.33		118	2.02
2	145.4		41	25.11		80	6.13		119	1.96
3	138.3		42	24.13		81	5.93		120	1.91
4	131.5		43	23.19		82	5.75		121	1.86
5	125.1		44	22.29		83	5.57		122	1.82
6	119.1		45	21.43		84	5.39		123	1.77
7	113.4		46	20.6		85	5.22		124	1.73
8	108		47	19.81		86	5.06		125	1.68
9	102.8		48	19.06		87	4.90		126	1.64

Airwell