

Service Manual

Flow Logic II YCVFD series

R410A

English Manual

AWAU-YCVFD220-H13

AWAU-YCVFD280-H13

AWAU-YCVFD335-H13

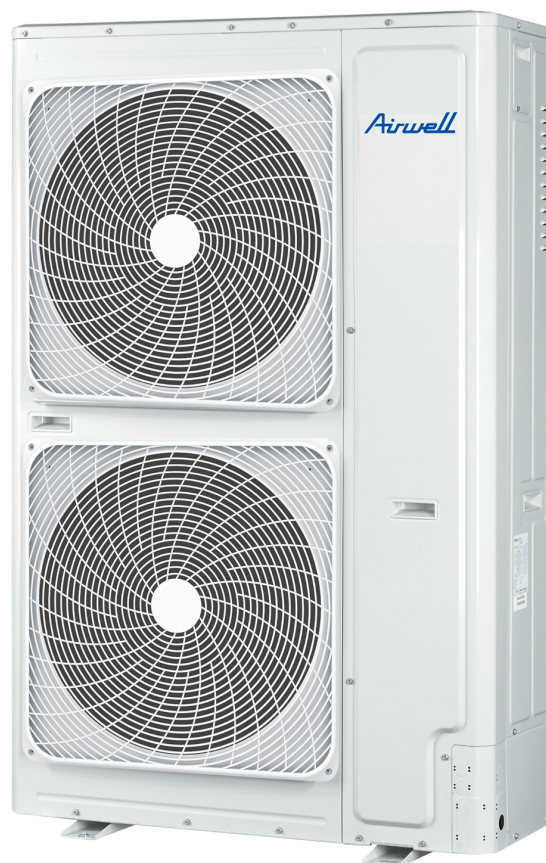

IMPORTANT NOTE:

Read this manual carefully before installing or operating your new air conditioning unit. Make sure to save this manual for future reference.







CONTENTS

1. General Information.....	1
2. Specification	7
3. Refrigerant Circuit.....	13
4. Dimension	14
5. Wiring Diagram.....	15
6. Performance Curves.....	17
7. Noise Level.....	19
8. Outdoor Installation	20
9. Electric Installation.....	40
10. Trial Operation	44
11. Dip Switch Setting.....	54
12. Digital Tube Display.....	57
13. Failure Code.....	58
14. Troubleshooting.....	63
APPENDIX	81

1. General Information

1.1 Indoor units

<p>4-WAY CASSETTE TYPE/CBV PANEL 600X600</p> <p>AWSI-CBV005-N11 AWSI-CBV007-N11 AWSI-CBV009-N11 AWSI-CBV012-N11 AWSI-CBV016-N11</p> 	<p>ROUND-WAY SMART AIR FLOW CASSETTE/ PANEL 900X900</p> <p>AWSI-CFV007-N11 AWSI-CFV009-N11 AWSI-CFV012-N11 AWSI-CFV016-N11 AWSI-CFV018-N11</p>  <p>AWSI-CFV024-N11</p> <p>AWSI-CFV030-N11 AWSI-CFV038-N11</p> <p>AWSI-CFV048-N11 AWSI-CFV060-N11</p>
<p>4-WAY CASSETTE TYPE/CCV PANEL 900X900</p> <p>AWSI-CCV018-N11 AWSI-CCV024-N11</p>  <p>AWSI-CCV030-N11 AWSI-CCV038-N11 AWSI-CCV048-N11</p> 	<p>ONE WAY CASSETTE TYPE/Panel for CDV to s12</p> <p>AWSI-CDV007-N11 AWSI-CDV009-N11 AWSI-CDV012-N11</p> 
<p>2-WAY CASSETTE TYPE/ PANEL FOR CEV</p> <p>AWSI-CEV009-N11 AWSI-CEV012-N11 AWSI-CEV016-N11 AWSI-CEV018-N11</p> 	<p>LOW ESP DUCT TYPE</p>  
<p>SLIM LOW ESP DUCT</p> <p>AWSI-DDV007-N11 AWSI-DDV009-N11 AWSI-DDV012-N11 AWSI-DDV016-N11</p>  	<p>MED ESP DUCT TYPE (50/100Pa)</p> <p>AW-DBV005-N11 AW-DBV007-N11 AW-DBV009-N11 AW-DBV012-N11 AW-DBV016-N11</p>  <p>AW-DBV018-N11 AW-DBV024-N11 AW-DBV028-N11</p>  <p>MED ESP DUCT TYPE (50/100Pa)</p> <p>AW-DBV030-N11 AW-DBV038-N11 AW-DBV048-N11</p> 

<p>N HIGH WALL</p> <p>AWSI-HBV030-N11 AWSI-HBV007-N11 AWSI-HBV009-N11 AWSI-HBV012-N11 AWSI-HBV016-N11 AWSI-HBV018-N11 AWSI-HBV024-N11</p> 	<p>MED ESP DUCT TYPE (50/96Pa)</p> <p>AWSI-DBV018-N11 AWSI-DBV024-N11 AWSI-DBV028-N11</p>  <p>AWSI-DBV030-N11 AWSI-DBV038-N11 AWSI-DBV048-N11</p> 
<p>HIGH ESP DUCT TYPE</p> <p>AWSI-DCV018-N11 AWSI-DCV024-N11</p>  <p>AWSI-DCV030-N11 AWSI-DCV038-N11 AWSI-DCV048-N11</p> 	<p>CONVERTIBLE TYPE</p> <p>AWSI-FAV009-N11 AWSI-FAV012-N11 AWSI-FAV018-N11 AWSI-FAV024-N11</p>  <p>AWSI-FAV028-N11 AWSI-FAV030-N11 AWSI-FAV038-N11 AWSI-FAV048-N11</p>

1.2 Features

Outdoor structure

(8/10/12HP SIDE DISCHARGE)

More Bigger Outdoor Capacity, More Flexible Application

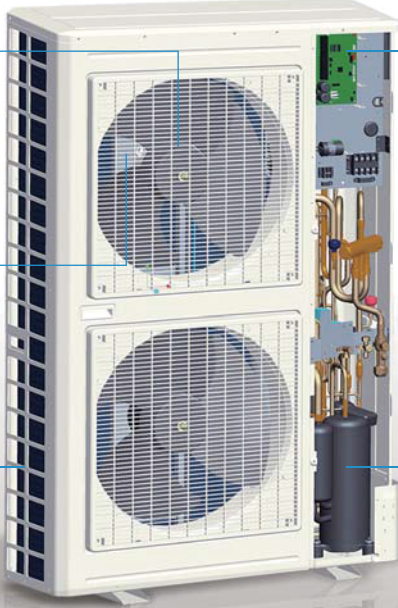

High efficiency DC fan motor

- DC fan motor with stepless inverter control, efficiency increase 45% comparing with AC motor and power input largely decrease

Large diameter fan

- 570mm big diameter axial flow fan
- Zigzag design, reduce airflow disturbance, air volume is bigger, the noise is lower

High efficiency condenser

- New type high efficiency Ø8 inner grooved tube
- New hydrophilic corrugated fissure fin, high efficiency

Vector inverter control

- 180 degrees sine wave vector control, 64-bit operation
- High precision control, to achieve high efficiency and lower noise

Double pressure sensor

- Equipped with high and low voltage Pressure double sensors
- Accurate Pressure control, the system run more smoothly, more energy efficiency

Twin rotary DC Inverter compressor

- High chamber DC INVERTER twin rotary compressor
- Small vibration, low noise, high energy efficiency

DC fan and fan motor

DC inverter fan motor more higher efficiency in part load running

- 16-stage speed control; high efficiency running especially in low speed
- Efficiency increase 45% comparing with AC motor and power input largely decrease big diameter fan
- 570mm big diameter fan, more big air flow and more higher efficiency

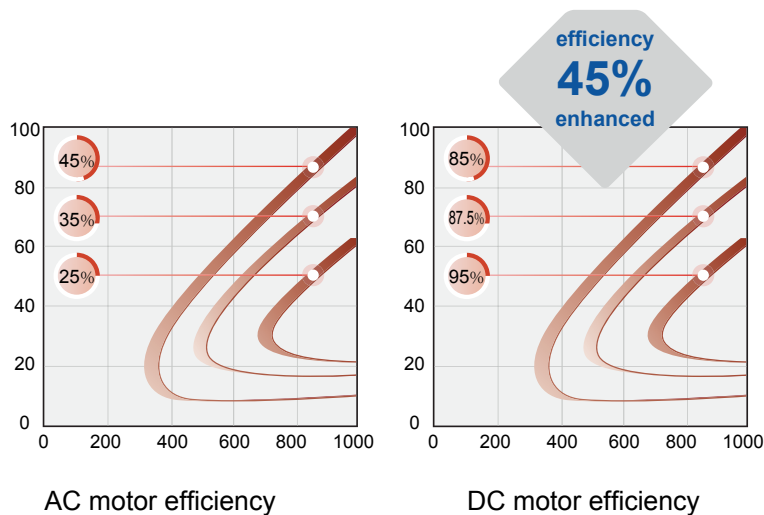

Ø570mm fan



DC motor

New DC inverter twin rotary compressor

- Small torque change, good dynamic balance, the system runs stably, little vibration, low noise, high efficiency
- More higher efficiency in part load running

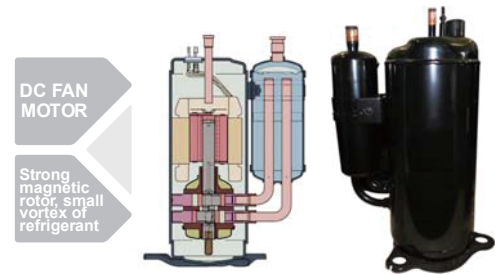

Low noise level

Night quiet operation function

Noise can be reduced to 45dB (A)

Low noise operation

- DC INVERTER compressor, smooth operation, no need frequent start the compressor, effectively reduce the noise outdoor
- Vector inverter control, more precise control
- DC fan motor, motor bracket used the non-resonance structure, ensure smooth running of the motor, reduce operating noise
- Big diameter fan, design according to aviation quieter principle



High reliability

Refrigerant automatically reclaim technology

Set refrigerant automatically reclaim through dip switch, the refrigerant in indoor and pipe can be automatically return to outdoor, convenient in maintenance and reducing waste of refrigerant, reduce customer maintenance cost, improve the efficiency of after-sales maintenance

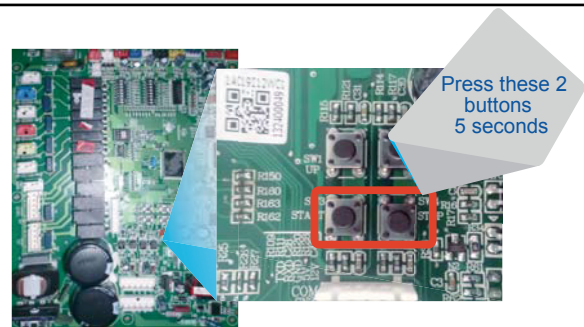

Refrigerant control technology

Refrigerant control technology without high pressure accumulator, reducing the refrigerant volume and enhancing the running efficiency

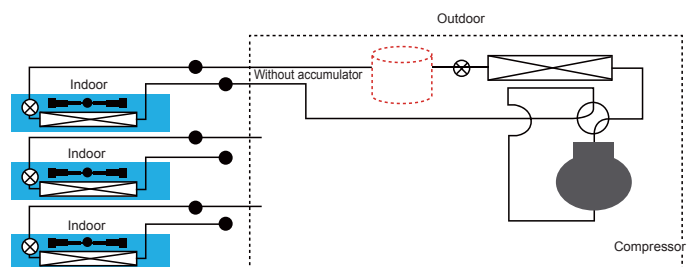

High reliability

Air inlet grill design on right side panel

Air inlet grill design, reducing the module temperature and avoid air dust into air conditioner

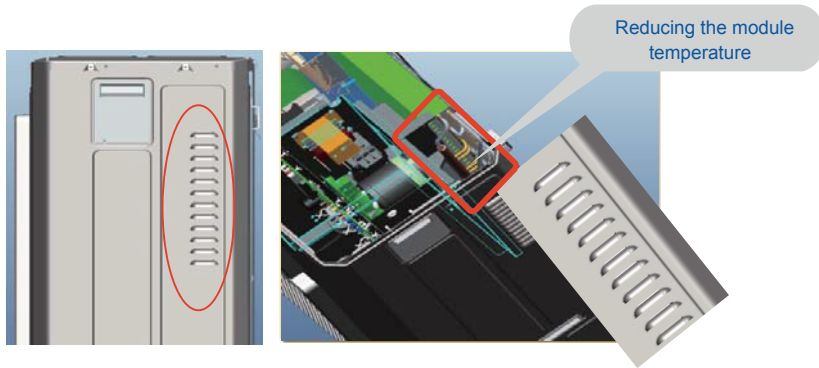

High and Low Double Pressure Sensor

Double pressure sensor with PID control technology

Together with high speed communication to realize the quick start of compressor and more precise control, the temperature can be control $\pm 0.5^{\circ}\text{C}$



Easy installation

Compact side discharge design, Big capacity, small floor area

Small floor area, only 0.42m^2 , 43% floor area can be reduced

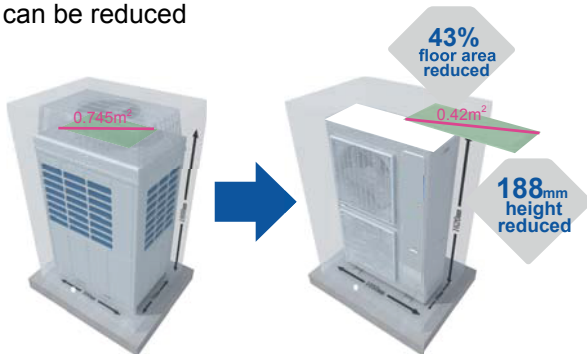

Compact side discharge design

No need additional ventilation hood comparing with top discharge unit

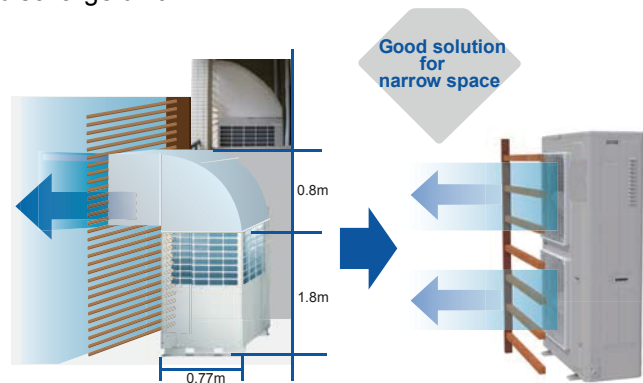

4 Way pipe connection

Front, rear, right, down 4 way pipe connection, flexible installation

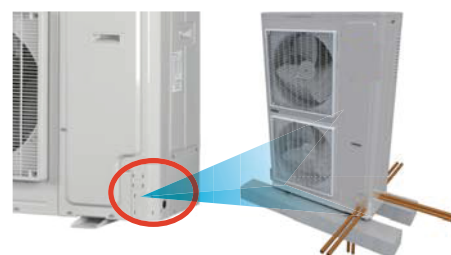

Long pipe length, high height drop

- Total pipe length: 300m
- Single pipe length: Max. 175m
- From outdoor to the first branch pipe: 135m
- From the first branch to the farthest indoor door unit: 40m Height drop: 50m (outdoor above)/40m (outdoor below)
- Height drop between indoor units: 15m

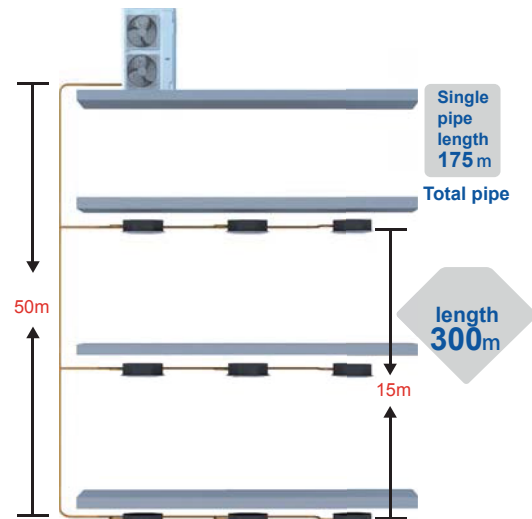

- Separate Refrigerant Charging Valve
- Easy for refrigerant charging

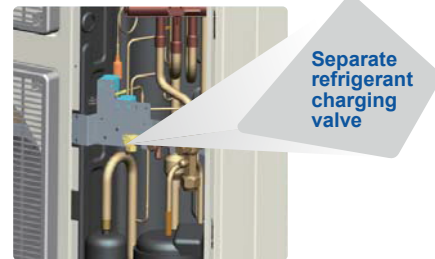

Easy service

Parameter display panel

- The first original parameter display panel on the side
- The parameter can be observed directly by opening the protective cover in case of maintenance, to avoid removing the repair board

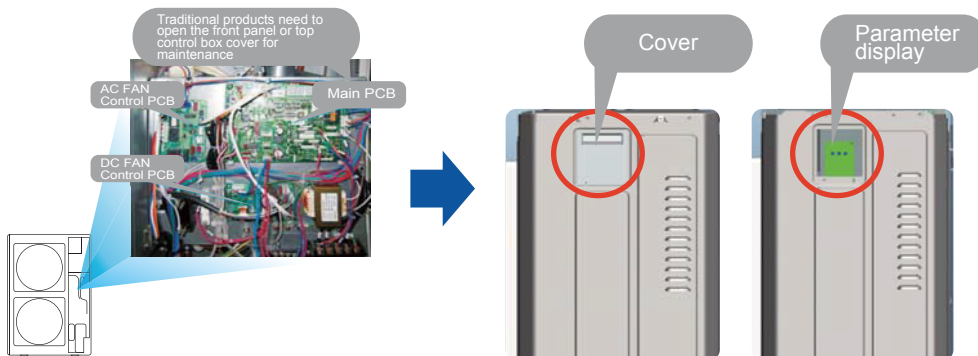

Easy maintenance for control

- The control box is in front, reserving space 108mm between control box and top panel, easy maintenance from the top Control box is with hinge design, easy to open for maintenance

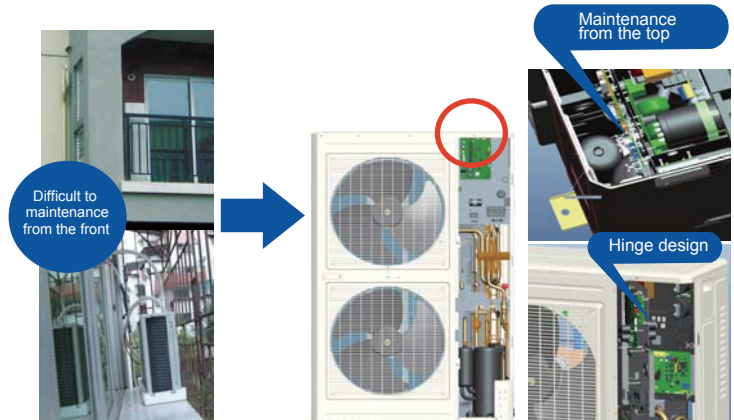

2. Specification

Model		AWAU-YCVFD220-H13	
Power supply		Ph/V/Hz	3/380~400/50/60
Cooling	Rated capacity	kW	22.6
	Rated capacity	kBtu/h	77.1
	Rated power input	kW	5.79
	Max. power input	kW	10.4
	EER		3.90
	Rated current	A	9.6
	Max. current	A	17.2
Heating	Rated capacity	kW	25.0
	Rated capacity	kBtu/h	85.3
	Rated power input	kW	5.43
	Max. power input	kW	9.8
	COP		4.60
	Rated current	A	9.0
	Max. current	A	16.2
Compressor	Brand		MITSUBISHI ELECTRIC
	Model		LNB53FCAMC
	Type		Rotary
	Compressor quantity		1 INV
	Capacity	W	16860
	Power Input	W	5200
	Rated current (RLA)	A	15.4
	Speed	rps	60
	Crankcase Heater	W	56
	Refrigerant oil brand		Itochu.,LTD.,Shanghai
	Refrigerant oil type		FV50S
	Refrigerant oil charge	ml	1700
Outdoor fan motor	Brand		NIDEC/BROAD OCEAN
	Model		SIC-81FW-F1145-1/Y7S623D811
	Voltage		310/220-230
	IP Class		IP44/IP44
	Type		DC/AC
	Insulation class		E/B
	Safe class		I/I
	Power Input	W	185/346
	Output	W	145/180
	Rated current	A	0.84/1.43
	Capacitor	μF	/10
	Speed	rpm	770/850
Outdoor fan	Brand		LANGDI
	Model		/
	Material		Plastic
	Type		Axial
	Diameter	mm	570
	Height	mm	202

Model		AWAU-YCVFD220-H13	
Outdoor coil	Number of rows		2
	Tube pitch (a)×row pitch (b)	mm	22×19.05
	Fin spacing	mm	1.55
	Fin type (code)		Fracture
	Fin coating type	Optional	Hydrophilic aluminum
	Salt spray test duration	Hour	500
	Tube outside dia.and type	mm	Internal thread copper tube Φ8
	Coil length × height	mm	1122×1584
	Number of circuits		14
Cabinet coating	Coating type		Powder Coating
	Salt spray test duration	Hour	500
	Sheet metal material		Hot zinc plate
	Sheet metal thickness	mm	1.0
Control panel enclosure IP class		Standard	IP24
Outdoor air flow		m ³ /h	10000
Outdoor sound level (sound pressure level)		dB (A)	55
Outdoor sound level (sound power level)		dB (A)	66
Outdoor unit	Dimension (W*D*H)	mm	1050×400×1636
	Packing (W*D*H)	mm	1150×510×1795
	Net weight	kg	168
	Gross weight	kg	183
Refrigerant	Type		R410A
	Charged volume	kg	6.1
Throttle type			EXV
Design pressure		MPa	4.15
Refrigerant piping	Liquid pipe	mm	9.52
	Gas pipe	mm	19.05
	Total pipe lenth	m	300
	Max. pipe length (Equivalent/ Actual)	m	175/150
	Max.Diff. indoor/ outdoor unit	m	50 (Outdoor higher than indoor) 40 (Indoor higher than outdoor)
	Max.Diff. indoor/indoor unit	m	15
Connectable indoor unit ratio		%	50%~130%
Maximum indoor units		Piece	13
Connection wiring	Power wiring	mm ²	6
	Signal wiring	mm ²	Shield wire: (0.75-2) *2
Operation Range		°C	Cooling: -5~43 Heating: -15~21

■ Norminal condition: indoor temperature (cooling): 27DB (°C)/19WB (°C), indoor temperature (heating): 20DB (°C)/14.5 WB(°C) Outdoor temperature (cooling): 35DB (°C)/24WB (°C), outdoor temperature (heating): 7DB (°C)/6WB (°C)

The noise level will be measured in the third octave band limited values in the semi-anechoic chamber, using a Real Time Analyser calibrated sound intensity meter. It is a sound pressure noise level.

Model		AWAU-YCVFD280-H13	
Power supply		Ph/V/Hz	3/380~400/50/60
Cooling	Rated capacity	kW	28
	Rated capacity	kBtu/h	95.5
	Rated power input	kW	8
	Max. power input	kW	14.4
	EER		3.50
	Rated current	A	13.2
	Max. current	A	23.8
Heating	Rated capacity	kW	31.5
	Rated capacity	kBtu/h	107.5
	Rated power input	kW	7.5
	Max. power input	kW	12.4
	COP		4.20
	Rated current	A	12.4
	Max. current	A	22.3
Compressor	Brand		MITSUBISHI ELECTRIC
	Model		LNB53FCAMC
	Type		Rotary
	Compressor quantity		1 INV
	Capacity	W	16860
	Power Input	W	5200
	Rated current (RLA)	A	15.4
	Speed	rps	60
	Crankcase Heater	W	56
	Refrigerant oil brand		Itochu.,LTD.,Shanghai
	Refrigerant oil type		FV50S
	Refrigerant oil charge	ml	1700
Outdoor fan motor	Brand		NIDEC/BROAD OCEAN
	Model		SIC-81FW-F1145-1/Y7S623D811
	Voltage		310/220-230
	IP Class		IP44/IP44
	Type		DC/AC
	Insulation class		E/B
	Safe class		I/I
	Power Input	W	185/346
	Output	W	145/180
	Rated current	A	0.84/1.43
	Capacitor	μF	/10
	Speed	rpm	770/850
Outdoor fan	Brand		LANGDI
	Model		/
	Material		Plastic
	Type		Axial
	Diameter	mm	570
	Height	mm	202

Model		AWAU-YCVFD280-H13	
Outdoor coil	Number of rows		2
	Tube pitch (a)× row pitch (b)	mm	22×19.05
	Fin spacing	mm	1.55
	Fin type (code)		Fracture
	Fin coating type	Optional	Hydrophilic aluminum
	Salt spray test duration	Hour	500
	Tube outside dia.and type	mm	Internal thread copper tube Φ8
	Coil length × height	mm	1122×1584
	Number of circuits		14
Cabinet coating	Coating type		Powder Coating
	Salt spray test duration	Hour	500
	Sheet metal material		Hot zinc plate
	Sheet metal thickness	mm	1.0
Control panel enclosure IP class		Standard	IP24
Outdoor air flow		m ³ /h	10000
Outdoor sound level (sound pressure level)		dB (A)	58
Outdoor sound level (sound power level)		dB (A)	69
Outdoor unit	Dimension (W*D*H)	mm	1050×400×1636
	Packing (W*D*H)	mm	1150×510×1795
	Net weight	kg	168
	Gross weight	kg	183
Refrigerant	Type		R410A
	Charged volume	kg	6.1
Throttle type			EXV
Design pressure		MPa	4.15
Refrigerant piping	Liquid pipe	mm	12.7
	Gas pipe	mm	22.22
	Total pipe lenth	m	300
	Max. pipe length (Equivalent/ Actual)	m	175/150
	Max.Diff. indoor/ outdoor unit	m	50 (Outdoor higher than indoor) 40 (Indoor higher than outdoor)
	Max.Diff. indoor/indoor unit	m	15
Connectable indoor unit ratio		%	50%~130%
Maximum indoor units		Piece	16
Connection wiring	Power wiring	mm ²	10
	Signal wiring	mm ²	Shield wire: (0.75-2) *2
Operation Range		°C	Cooling: -5~43 Heating:-15~21

■ Norminal condition: indoor temperature (cooling): 27DB (°C)/19WB (°C), indoor temperature (heating): 20DB (°C)/14.5 WB (°C) Outdoor temperature (cooling): 35DB (°C)/24WB (°C), outdoor temperature (heating): 7DB (°C)/6WB (°C)

The noise level will be measured in the third octave band limited values in the semi-anechoic chamber, using a Real Time Analyser calibrated sound intensity meter. It is a sound pressure noise level.

Model		AWAU-YCVFD335-H13	
Power supply		Ph/V/Hz	3/380~400/50/60
Cooling	Rated capacity	kW	33.5
	Rated capacity	kBtu/h	114.3
	Rated power input	kW	9.75
	Max. power input	kW	15.4
	EER		3.44
	Rated current	A	16.4
	Max. current	A	26.0
Heating	Rated capacity	kW	37.5
	Rated capacity	kBtu/h	128.0
	Rated power input	kW	9.62
	Max. power input	kW	15.0
	COP		3.90
	Rated current	A	16.2
	Max. current	A	25.3
Compressor	Brand		mitsubishi electric
	Model		LNB53FCAMC
	Type		Rotary
	Compressor quantity		1 INV
	Capacity	W	16860
	Power input	W	5200
	Rated current (RLA)	A	15.4
	Speed	rps	60
	Crankcase heater	W	56
	Refrigerant oil brand		Itochu.,LTD.,Shanghai
	Refrigerant oil type		FV50S
	Refrigerant oil charge	ml	1700
Outdoor fan motor	Brand		NIDEC/BROAD OCEAN
	Model		SIC-81FW-F1145-1/Y7S623D811
	Voltage		310/220-230
	IP class		IP44/IP44
	Type		DC/AC
	Insulation class		E/B
	Safe class		I/I
	Power input	W	185/346
	Output	W	145/180
	Rated current	A	0.84/1.43
	Capacitor	μF	/10
	Speed	rpm	770/850
Outdoor fan	Brand		LANGDI
	Model		/
	Material		Plastic
	Type		Axial
	Diameter	mm	570
	Height	mm	202

Model		AWAU-YCVFD335-H13	
Outdoor coil	Number of rows		2
	Tube pitch (a)× row pitch (b)	mm	22×19.05
	Fin spacing	mm	1.55
	Fin type (code)		Fracture
	Fin coating type	Optional	Hydrophilic aluminum
	Salt spray test duration	Hour	500
	Tube outside dia.and type	mm	Internal thread copper tube Φ8
	Coil length × height	mm	1122×1584
	Number of circuits		14
Cabinet coating	Coating type		Powder Coating
	Salt spray test duration	Hour	500
	Sheet metal material		Hot zinc plate
	Sheet metal thickness	mm	1.0
Control panel enclosure IP class		Standard	IP24
Outdoor air flow		m ³ /h	10000
Outdoor sound level (sound pressure level)		dB (A)	60
Outdoor sound level (sound power level)		dB (A)	71
Outdoor unit	Dimension (W*D*H)	mm	1050×400×1636
	Packing (W*D*H)	mm	1150/510/1795
	Net weight	kg	168
	Gross weight	kg	183
Refrigerant	Type		R410A
	Charged volume	kg	6.1
Throttle type			EXV
Design pressure		MPa	4.15
Refrigerant piping	Liquid pipe	mm	12.7
	Gas pipe	mm	25.4
	Total pipe lenth	m	300
	Max. pipe length (Equivalent/ Actual)	m	175/150
	Max.Diff. indoor/ outdoor unit	m	50 (Outdoor higher than indoor) 40 (Indoor higher than outdoor)
	Max.Diff. indoor/indoor unit	m	15
Connectable indoor unit ratio		%	50%~130%
Maximum indoor units		Piece	16
Connection wiring	Power wiring	mm ²	10
	Signal wiring	mm ²	Shield wire: (0.75-2) *2
Operation Range		°C	Cooling: -5~43 Heating:-15~21

■ Norminal condition: indoor temperature (cooling): 27DB (°C)/19WB (°C), indoor temperature (heating): 20DB (°C)/14.5 WB(°C) Outdoor temperature (cooling): 35DB (°C)/24WB (°C), outdoor temperature (heating): 7DB (°C)/6WB (°C)

The noise level will be measured in the third octave band limited values in the semi-anechoic chamber, using a Real Time Analyser calibrated sound intensity meter. It is a sound pressure noise level.

3. Refrigerant Circuit

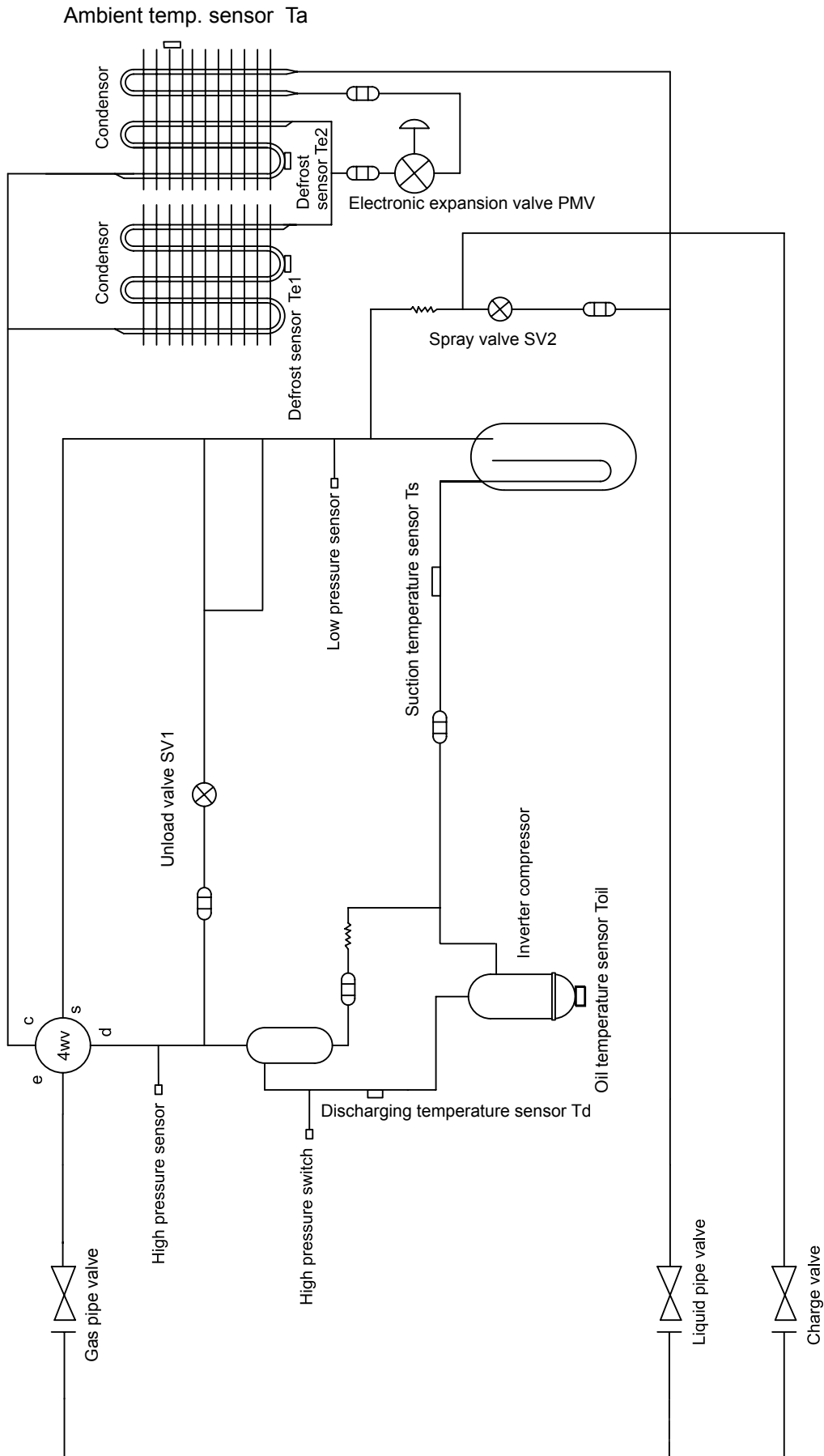

4. Dimension

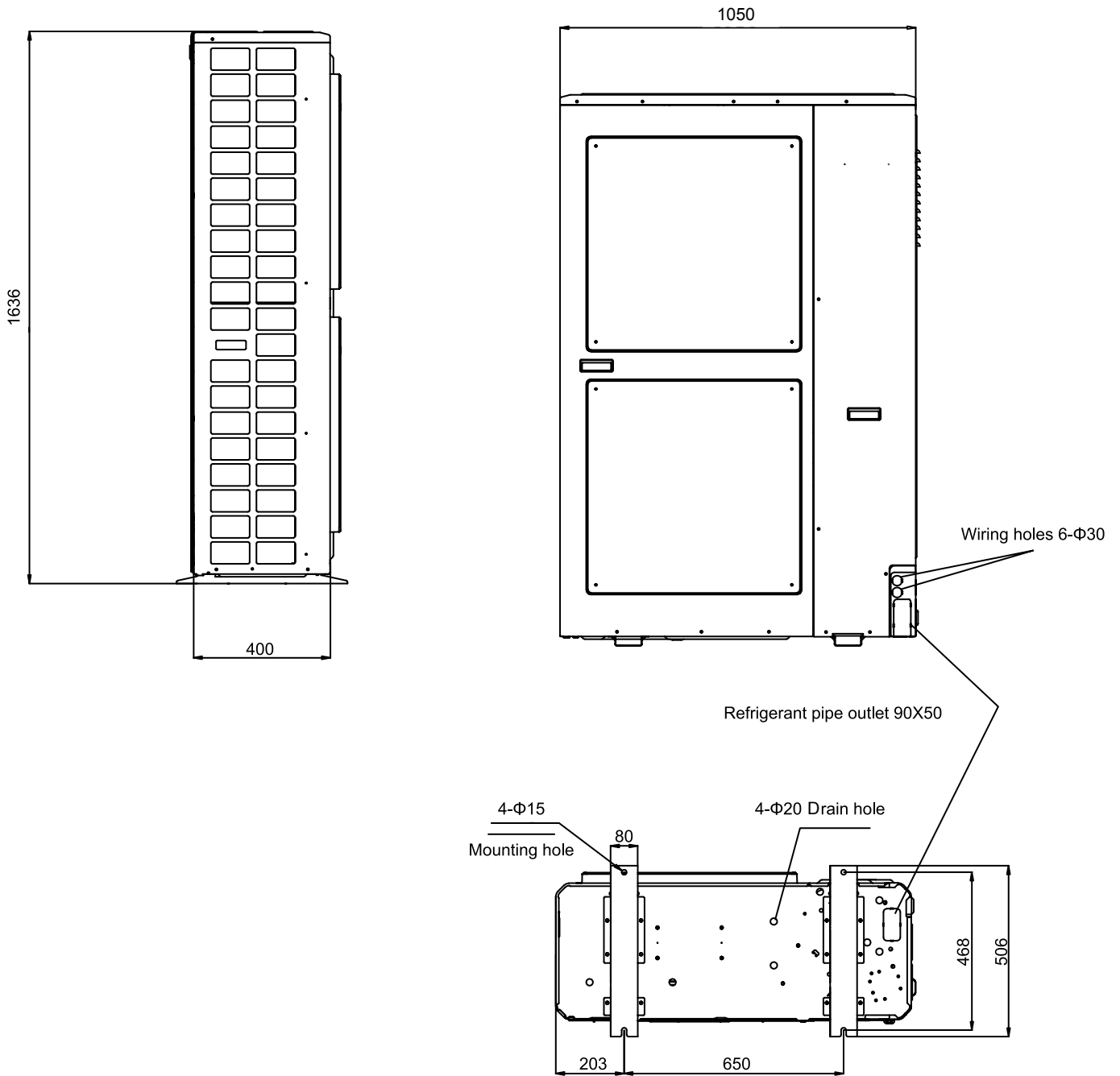

5. Wiring Diagram

New (the unit with relay)

0150513195

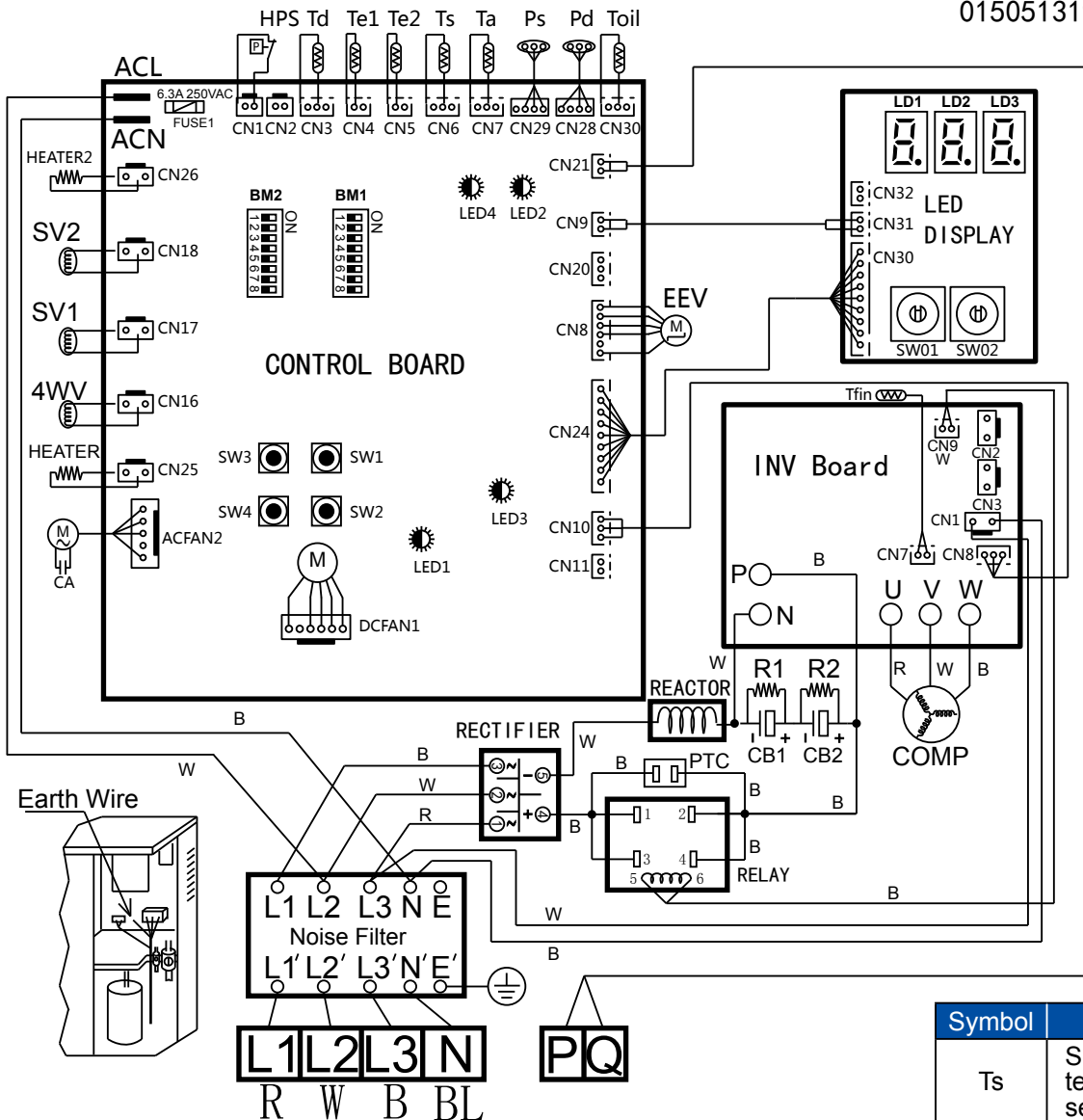

⚠ WARNING

Please power off firstly for about 10 minutes before checking control box, and make sure the voltage between P and N below 20V.

Notes

• Please check the power firstly before test, and make sure the crankcase heater powering on for 12 hours at least to protecting compressor. The switch BM1-1 is used for locking the indoor units number, the initial situation is "OFF". After power on, the display board will display 【U**】 , "**" indicates the number of indoor units that the outdoor unit can communicate with. If it can match the actual number of indoor units, please change "OFF" to "ON", or else fix the communication problem firstly. Forbid connecting the power wire to the "P" and "Q", otherwise the control board will be damaged. Please make sure the earth wire connecting the grounding hole on the electric box firmly.

SYMBOL

Symbol	Signification
HEATER, 2	Crankcase heater
SV1	Unloading valve
SV2	Spray valve
4WV	4-way valve
CA	Capacitor
ACFAN2	AC fan motor
DCFAN1	DC fan motor
HPS	High pressure switch
Td	Discharging temp. sensor
Te1, 2	Defrost temperature sensor

Symbol	Signification
Ts	Suction temperature sensor
Ta	Ambient temperature sensor
Pd	High pressure sensor
Ps	Low pressure sensor
Toil	Oil temperature sensor
EEV	Electronic expansion valve
Tfin	IPM temperature sensor
CB1, 2	Electrolytic capacitor
R	Red
W	White
BL	Blue
B	Black
Y	Yellow

Old (the unit with AC contactor)

0150513195

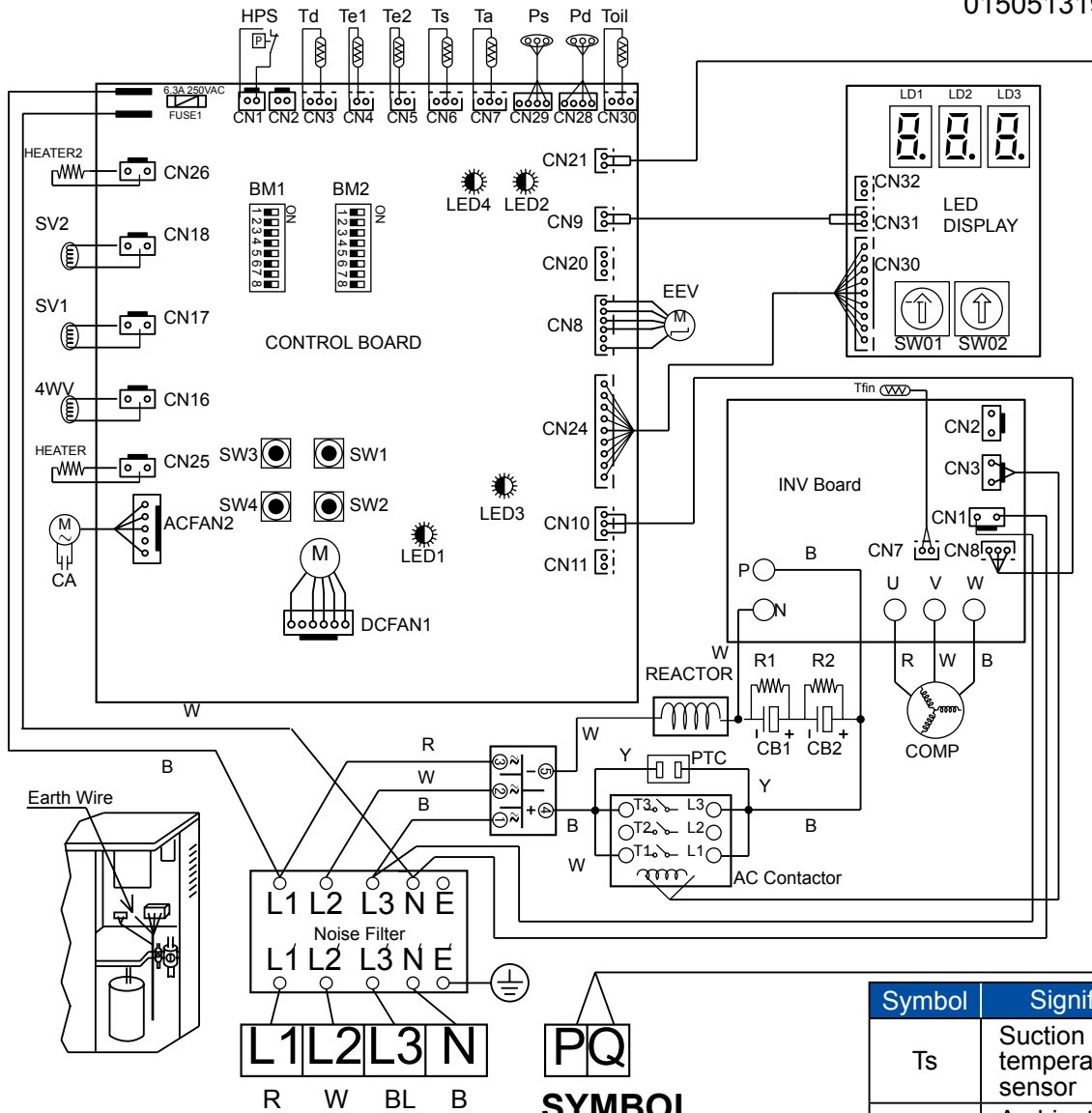

⚠ WARNING

Please power off firstly for about 10 minutes before checking control box, and make sure the voltage between P and N below 20V.

Notes

• Please check the power firstly before test, and make sure the crankcase heater powering on for 12 hours at least to protecting compressor. The switch BM1-1 is used for locking the indoor units number, the initial situation is "OFF". After power on, the display board will display 【U**】 , "**" indicates the number of indoor units that the outdoor unit can communicate with. If it can match the actual number of indoor units, please change "OFF" to "ON", or else fix the communication problem firstly. Forbid connecting the power wire to the "P" and "Q", otherwise the control board will be damaged. Please make sure the earth wire connecting the grounding hole on the electric box firmly.

SYMBOL

Symbol	Signification
HEATER, 2	Crankcase heater
SV1	Unloading valve
SV2	Spray valve
4WV	4-way valve
CA	Capacitor
ACFAN2	AC fan motor
DCFAN1	DC fan motor
HPS	High pressure switch
Td	Discharging temp. sensor
Te1, 2	Defrost temperature sensor

Symbol	Signification
Ts	Suction temperature sensor
Ta	Ambient temperature sensor
Pd	High pressure sensor
Ps	Low pressure sensor
Toil	Oil temperature sensor
EEV	Electronic expansion valve
Tfin	IPM temperature sensor
CB1, 2	Electrolytic capacitor
R	Red
W	White
BL	Blue
B	Black
Y	Yellow

6. Performance Curves

(1) Calculation method of refrigerating capacity----refrigerating capacity to be known=refrigerating capacity*(A*B*C*D*E)W

A. Capacity compensation value of indoor air wet-bulb temperature condition

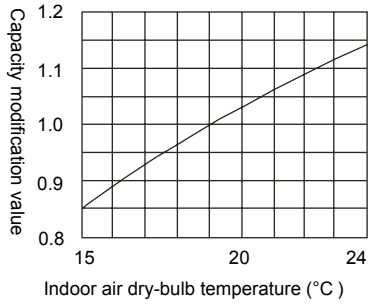

B. Capacity compensation value of outdoor air dry-bulb temperature condition

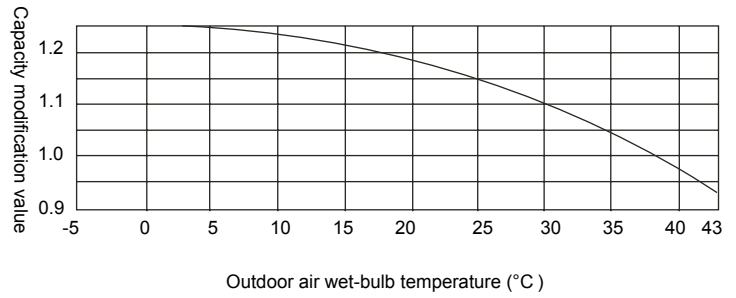

C. Capacity modification value under airflow variation rate of indoor unit group (only fro duct unit)

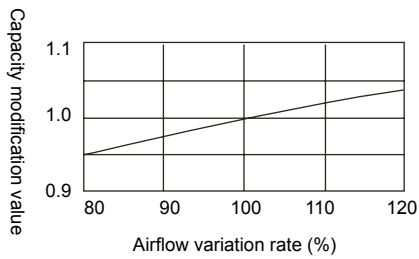

D. Capacity compensation suitable for total capability of indoor unit group

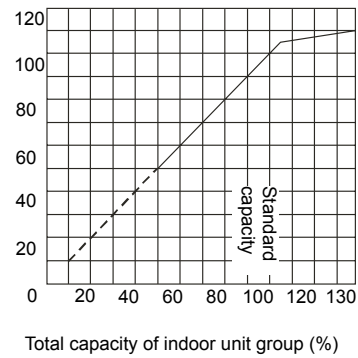

E. Fall of refrigerant pipe of indoor and outdoor unit, capacity compensation value of pipe length

AWAU-YCVFD220-H13

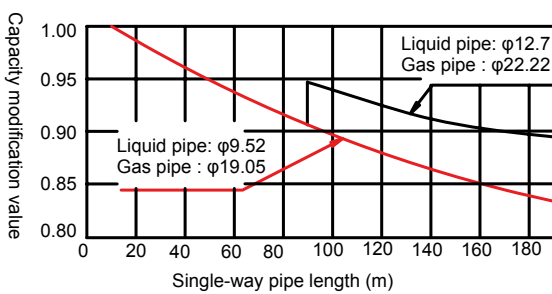

AWAU-YCVFD280-H13

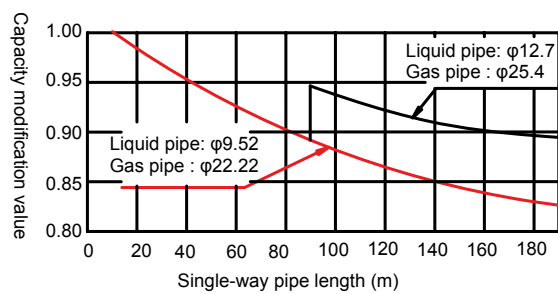

AWAU-YCVFD335-H13

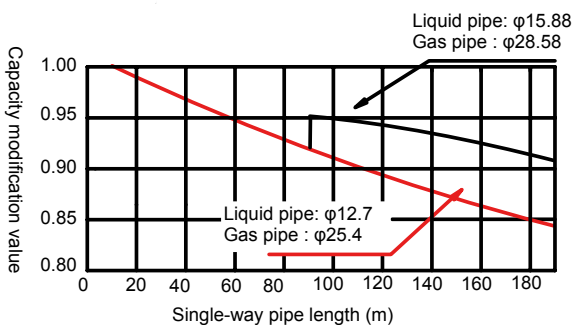

Notes:

- The refrigerant pipe should be thickened when the single way length is over 90m.
- When in cooling mode, outdoor is lower than indoor; or when in heating mode, outdoor is higher than indoor, the compensation factor should be decreased the below value from the above figure.

Vertical height drop between indoor and outdoor	5m	10m	15m	20m	25m	30m	35m	40m	45m	50m
Adjustment factor	0.003	0.006	0.009	0.012	0.015	0.018	0.021	0.024	0.027	0.030

(2) Calculation method of refrigerating capacity----heating capacity to be known=refrigerating capacity*(A*B*C*D*E*F)W

A. Capacity compensation value of indoor air dry-bulb temperature condition

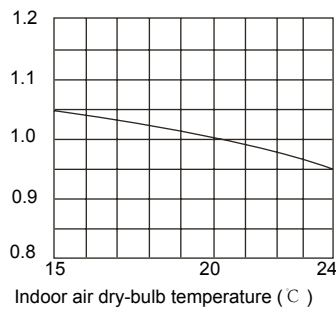

B. Capacity compensation value of outdoor air wet-bulb temperature condition

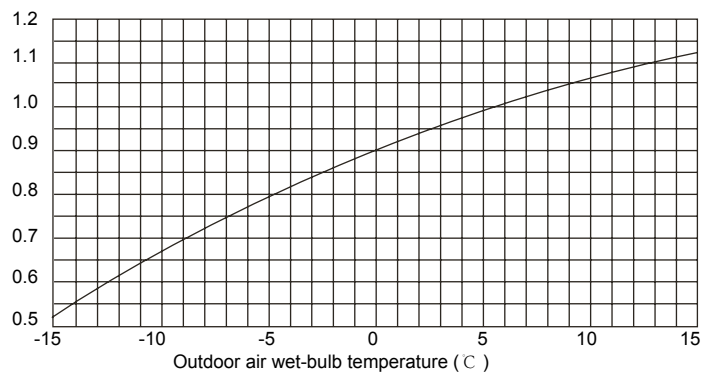

C. Capacity modification value under airflow variation rate of indoor unit group (only fro duct unit)

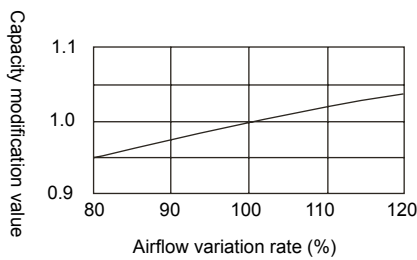

D. Capacity compensation suitable for total capability of indoor unit group

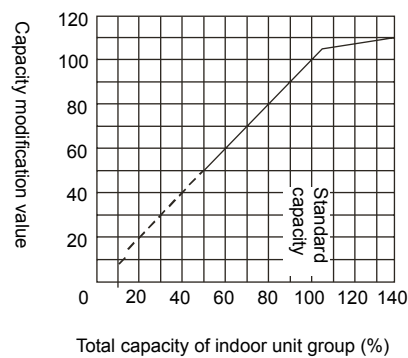

E. Capacity compensation value of pipe length between outdoors

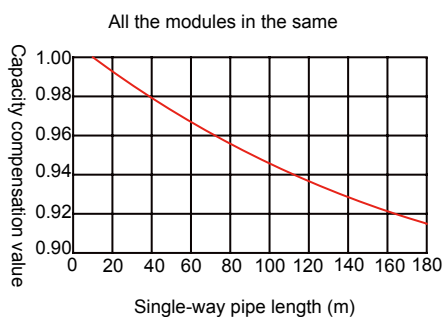

F. Capacity compensation value for defrost capability of outdoor heat exchanger

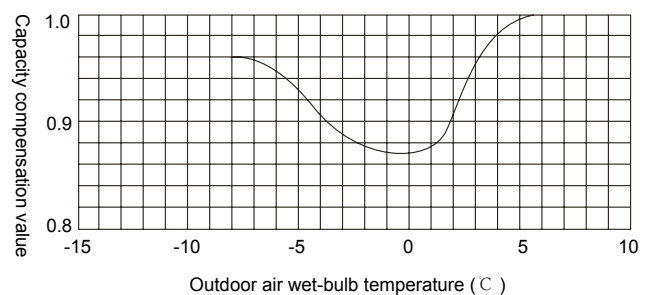

7. Noise Level

AWAU-YCVFD220-H13

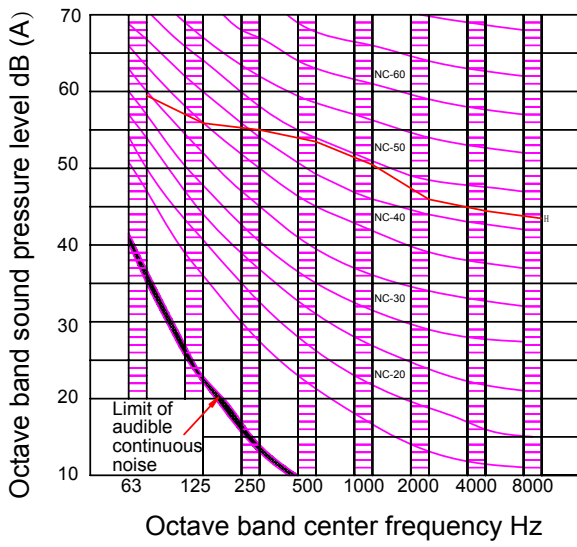

AWAU-YCVFD280-H13

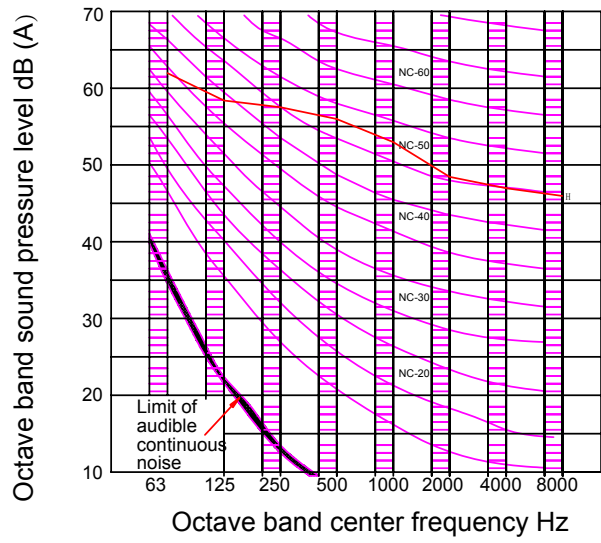

AWAU-YCVFD335-H13

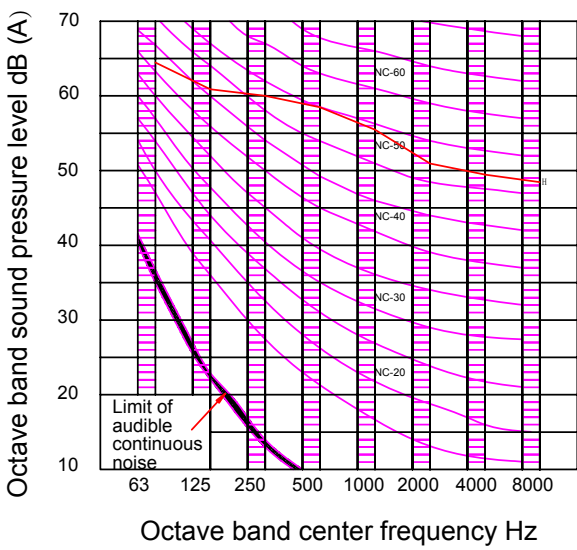

8. Outdoor Installation

- This manual should always be accessible and close to this air condition equipment.
- There are two types of indications, "WARNING" and "CAUTION". The indication preventing from death or heavy injury is listed as "WARNING". Even the indication listed as "CAUTION" may also cause serious accident. Both of them are related to safety, and should be strictly followed.
- After installation and start-up commissioning, please handover the manual to the user. The manual should be well kept in safe place and close to the unit.

WARNING

- The installation or the maintenance should be performed by an authorized agency. The wrong operation of this air condition equipment may cause water leakage, electric shock or fire.
- Please install the unit on the top of a solid foundation or structure which is strong enough to support the unit.
- The installation of this air condition equipment should follow local construction codes.
- Use the right cable size, secure the terminal firmly, organize the cables well and make sure no tension is added on cables. Cable insulation should not be damaged. The incorrect installation may lead to overheat or fire.
- When installing or moving the unit, the refrigerant system should be vacuumed and recharged with R410A refrigerant. If any other gas enters the system, it may lead to abnormal high pressure which may cause damage or injury.
- Please use the proper manifolds or branches during the system installation. The wrong parts may cause refrigerant leakage.
- Keep the drain pipe away from toxic gas vents to prevent possible pollution of indoor environment.
- During or after the installation, please check whether there is refrigerant leakage. If any leakage, please take any measures for ventilation. The refrigerant may be toxic at some concentration levels.
- The unit is not explosion-proof. Please keep it away from flammable gases.
- The drain pipe should be installed per this manual to ensure proper drainage. The pipe should be well insulated to avoid condensation. Wrong installation may lead to water leakage.
Both liquid pipe and the gas pipe should be also well insulated. Not enough insulation may lead to system performance deterioration or humidity formation.
- This air condition equipment is not intended to be operated by persons with lack of experience and training, unless they have supervision or instruction concerning use of this air condition equipment.
- Please keep children away from this air condition equipment.

CAUTION

- Grounding wire should be connected with the grounding bar. The grounding wire can not be connected to the gas pipe, water pipe, lightning rod or the telephone grounding wire. Improper grounding may cause electric shock.
- Units installed on roof should have appropriate access and handrail.
- Use the wrench to fasten the nut and flare at proper torque. Excessive torque may cause flared section to broke leading to refrigerant leakage.
- After refrigerant pipe installation, please take nitrogen leakage test to avoid refrigerant leakage.
- R410A is the only permitted refrigerant.
- To avoid mischarging wrong refrigerant, the check valve diameter is changed for R410A. To strengthen the pipe, the flared pipe dimension is also changed. Please use R410A specified tools as shown below.

	R410A specified tools	Remarks
1	Gauge manifold	Range: HP >4.5MPa, LP >2MPa
2	Charge hose	Pressure: HP:5.3MPa, LP:3.5MPa
3	Electronic weight for charging R410A	No other means permitted
4	Torque wrench	
5	Flare tool	
6	Copper pipe gauge for adjusting projecting margin	
7	Vacuum pump fitting	Vacuum pump must be equipped with check valve
8	Leakage detector	Only Helium detector permitted

When charging refrigerant, the refrigerant must be in liquid state from the tank.

- To prevent EMC interference on other appliances, please keep indoor unit, outdoor unit, power cable and connecting wire at least 1m away from those appliances .
- Fluorescent lamp (reverse phase or rapid start type) may interfere the remote controller's signal. Please install indoor unit away from fluorescent lamp. The farther the better.

For installation, please review the items below:





- Is the connected units quantity and the total capacity in the allowable range?
- Is the refrigerant pipe length in the limited range?
- Is the pipe size proper? And if the pipe installed horizontally?
- Is the branch pipe installed horizontally or vertically?
- Is the additional refrigerant counted correctly and weighed by the standard balance?
- Is there refrigerant leakage?
- Is all the indoor power supplies can be on/off simultaneously?
- Is the power voltage in compliance with the data marked on the rating label?
- Is the address of indoors has been set?

(1) Before installation

- 1) Before installation, check if the model, power supply, pipe, wires and parts purchased respectively are correct.
- 2) Check if the indoors and outdoors can be combined as the following.

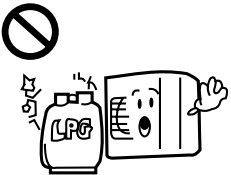
Outdoor		Indoor	
Model	Capacity (HP)	Indoor Qty	Total indoor capacity (HP)
AWAU-YCVFD220-H13	8	13	4~10.4
AWAU-YCVFD280-H13	10	16	5~13
AWAU-YCVFD335-H13	12	16	6~15.6

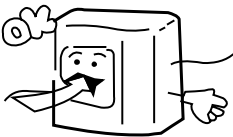
(2) Installation place selection

	<p>Air-conditioner can't be installed in the place with inflammable gas. Or it will cause fire hazard.</p>
	<p>The unit should be installed at the place where the cold/hot air or noise will not interfere the neighbours.</p>
	<p>The unit should be installed at the place with good ventilation. No obstacle at the air inlet/outlet. And no strong wind blows the unit. The installation space refers to the latter info.</p>
	<p>The unit should be installed at the strong enough place. Or it will cause vibration and noise.</p>
<ul style="list-style-type: none"> ■ The place where the water can flow fluently. ■ The place where no other heat source will affect the unit. ■ Pay attention to the snow against clogging the outdoor. ■ In installation, install the anti-vibration rubber between the unit and the bracket. 	
<ul style="list-style-type: none"> ■ The unit is better not be installed at the below places, or it will cause damage. ■ The place where there is corrosive gas (spa area etc). ■ The place blowing salty air (seaside etc). ■ Exists the strong coal smoke. ■ The place with high humidity. ■ The place where there is device emitting Hertzian waves. ■ The place where voltage changes greatly. 	

(3) Transportation and hoisting

Hoisting

- Please remove the outdoor unit to the installation location as far as possible near place before open the packaging.
- Forbid on the equipments to place anything, need to use 2 ropes while promoting outdoor.
- Please according to following way hoisting outdoor:
- Ensure that the outdoor unit when hosting the level to rise slowly.
- Do not remove the packaging.
- When hoisting do not have to tie up the elevator to the unit hits on the packaging and the outside wrapping.
- When hoisting exterior must use the suitable protection.

Handling

Before the installation, outdoor do not deposit any material, otherwise likely has the fire or the accident.

When handling unit, please operate as shown in the following figure and note the following points

1. Forbids to demolish the wooden foundation.
2. Prevent the outdoor to incline.
3. Should be handling more than two.

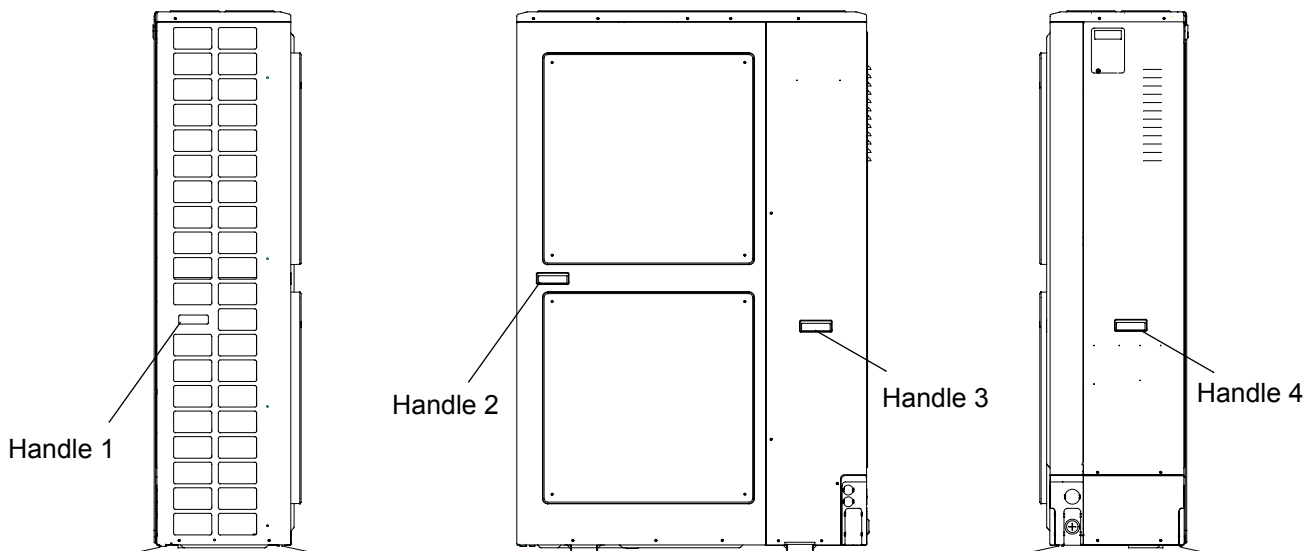

Outdoor installation

Installation location

- Outdoor unit should be placed in well ventilated and dry place.
- Outdoor noise and exhaust should not affect neighbors and around the ventilation.
- Ensure the ground steadily reliable.
- Do not install the outdoor unit on high oil, salt spray or harmful gases.
- Don't being installed to electromagnetic wave can directly radiate an electricity box and keep off electromagnetic wave radiation possibly, at least more than 3 meters.
- When ice snow overlay area installs outdoor unit, please add to defend snow cover.
- Outdoor unit installed in the shade, avoiding direct sunlight or high temperature heat sources of radiation.
- Do not install in dusty or polluted place to prevent outdoor unit heat exchanger jam.
- The outdoor unit should install in the public unapproachable place.

Installation and maintenance space

As shown below, install the outdoor unit should allow sufficient space for handing and maintenance.

Case 1: Stumbling block on the inlet , also upside opens.

Single installation around the opening

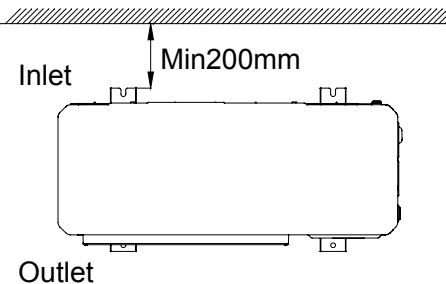

Single installation around the closed

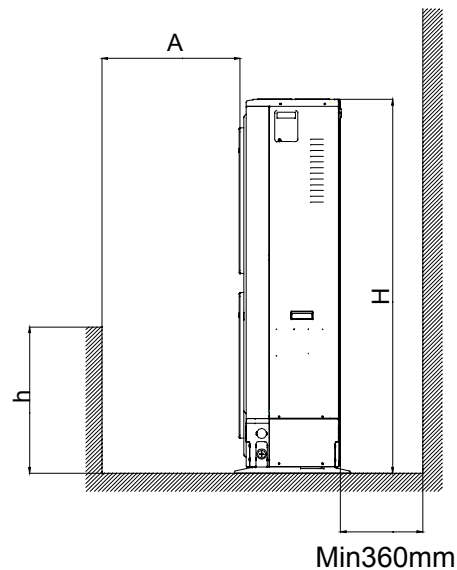
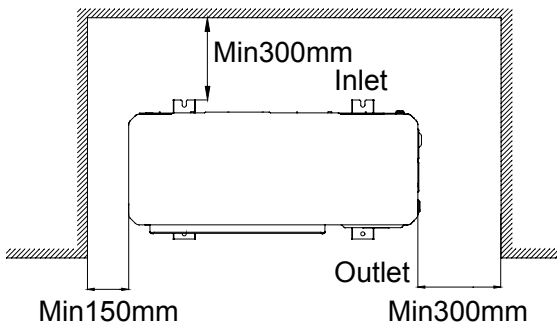

Multi Outdoor

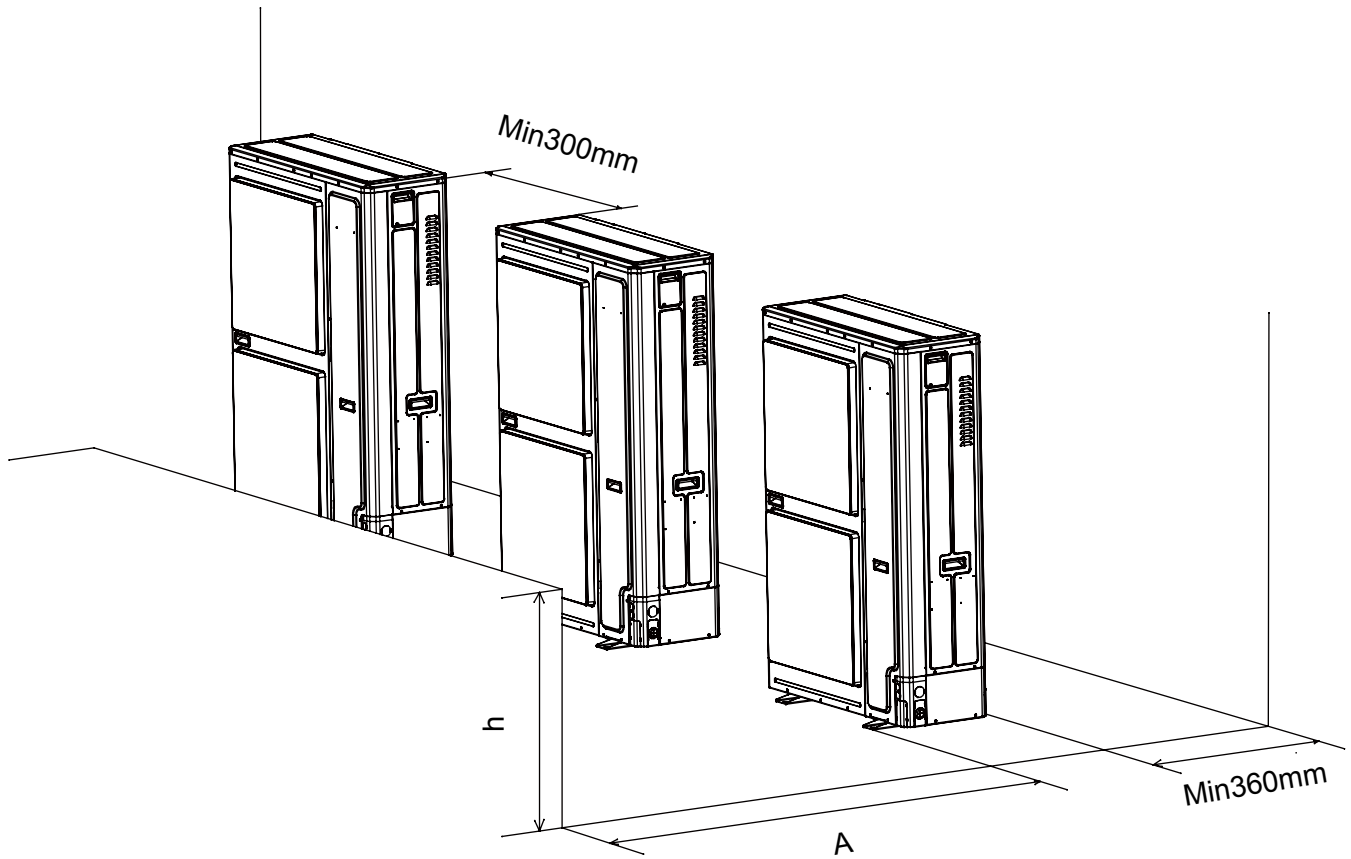
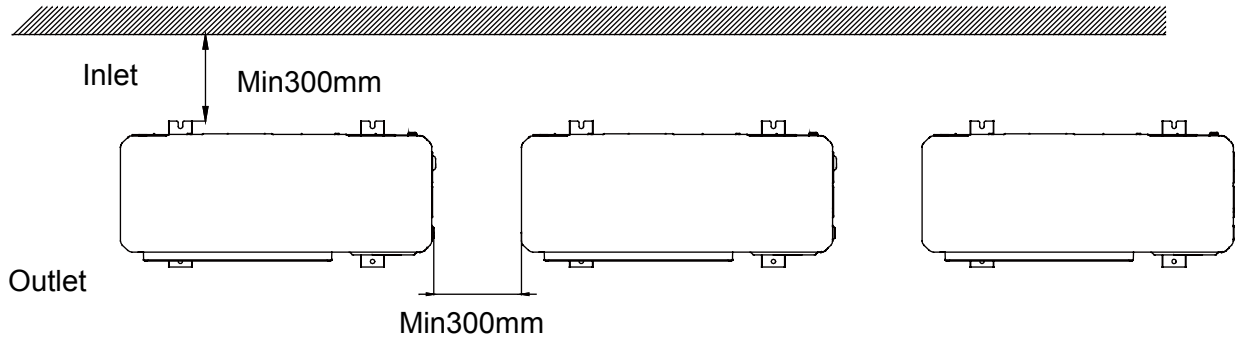

Case 2: Stumbling block on the inlet and top side

Single Outdoor

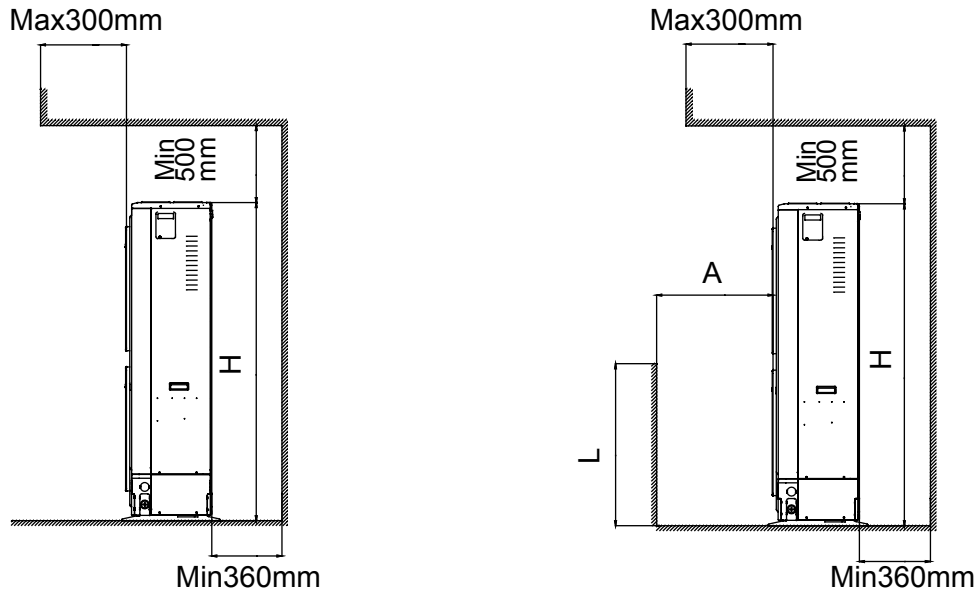

Multi Outdoor

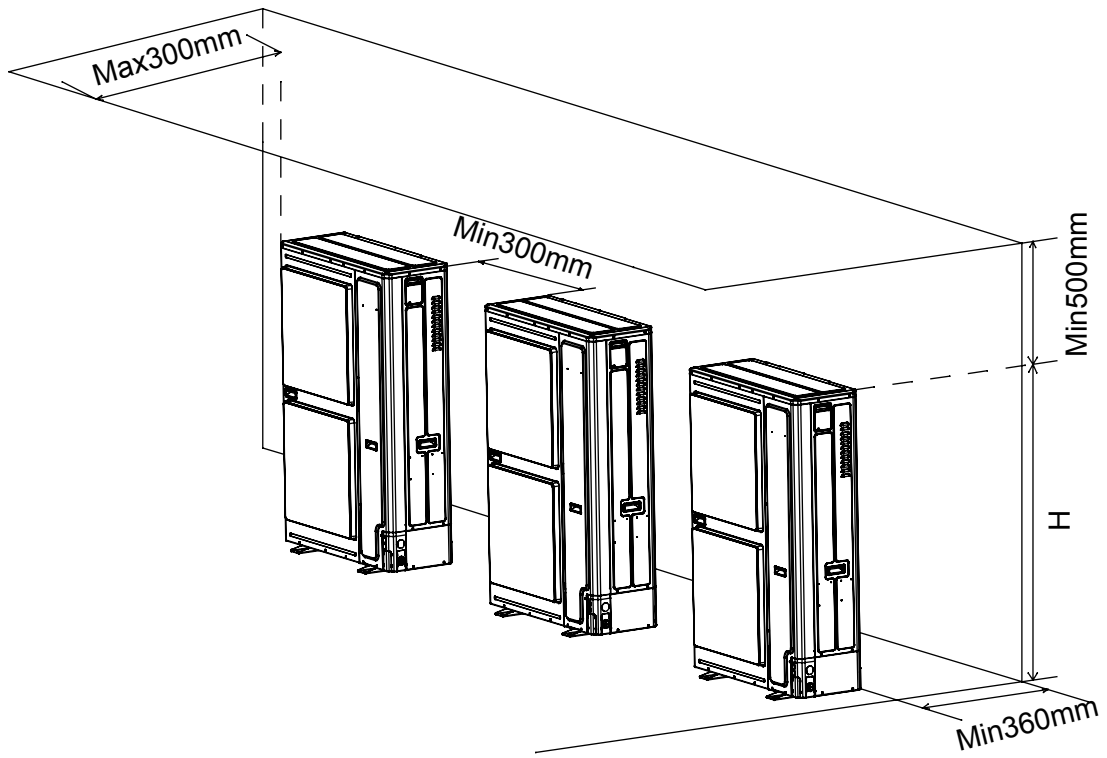

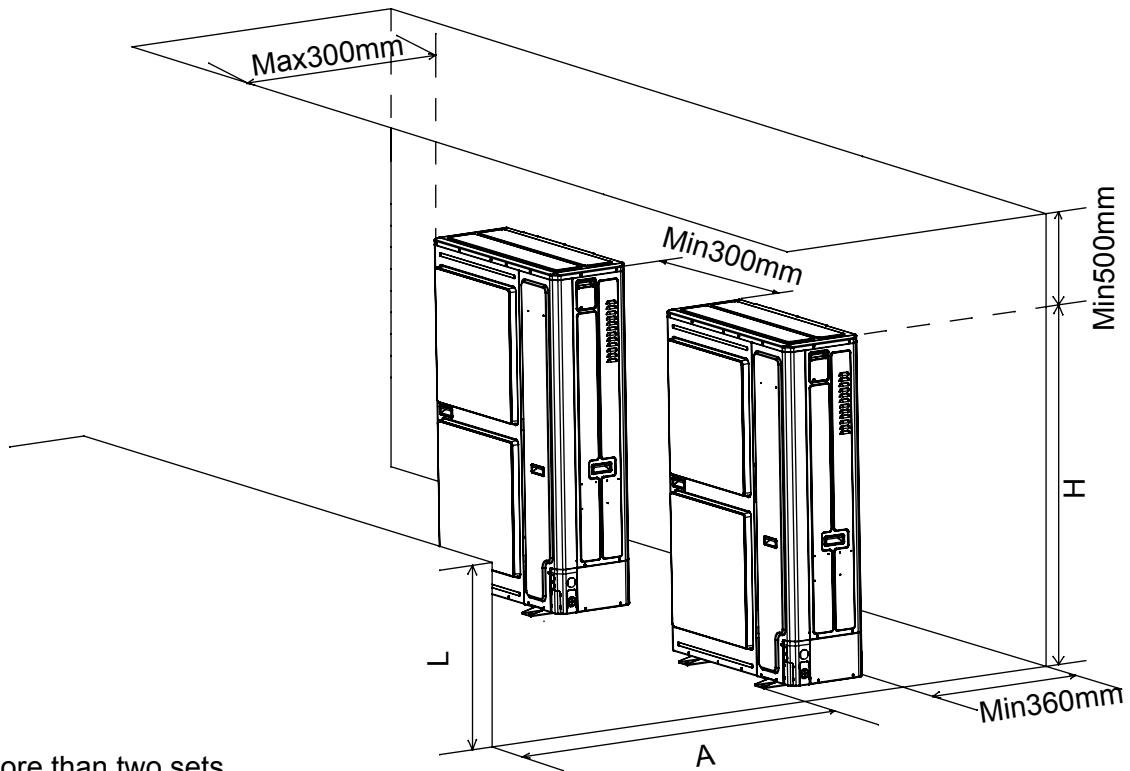

Not more than two sets

Case 3: Stumbling block on the outlet, both right and left side

Single Outdoor

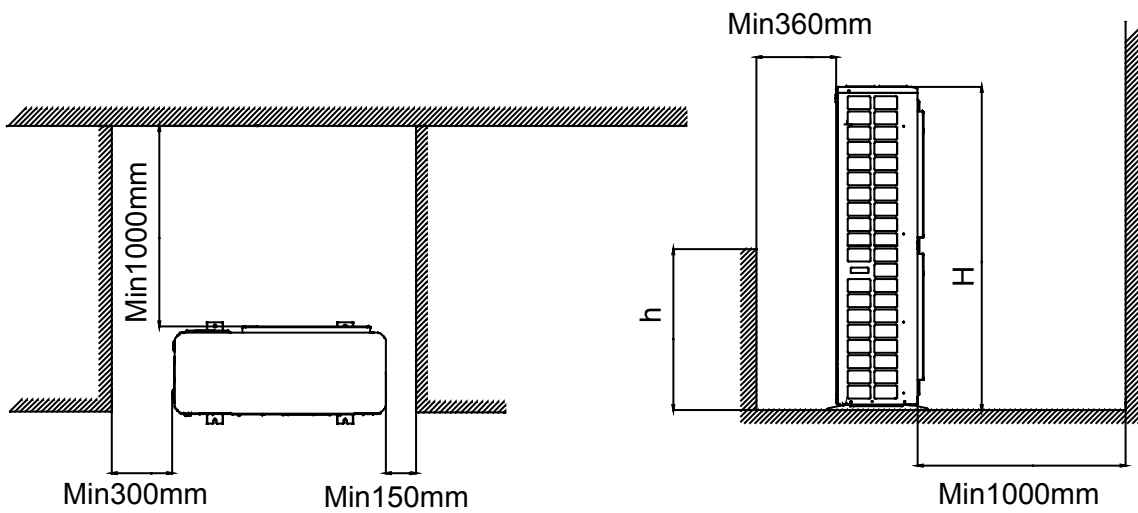

Multi Outdoor

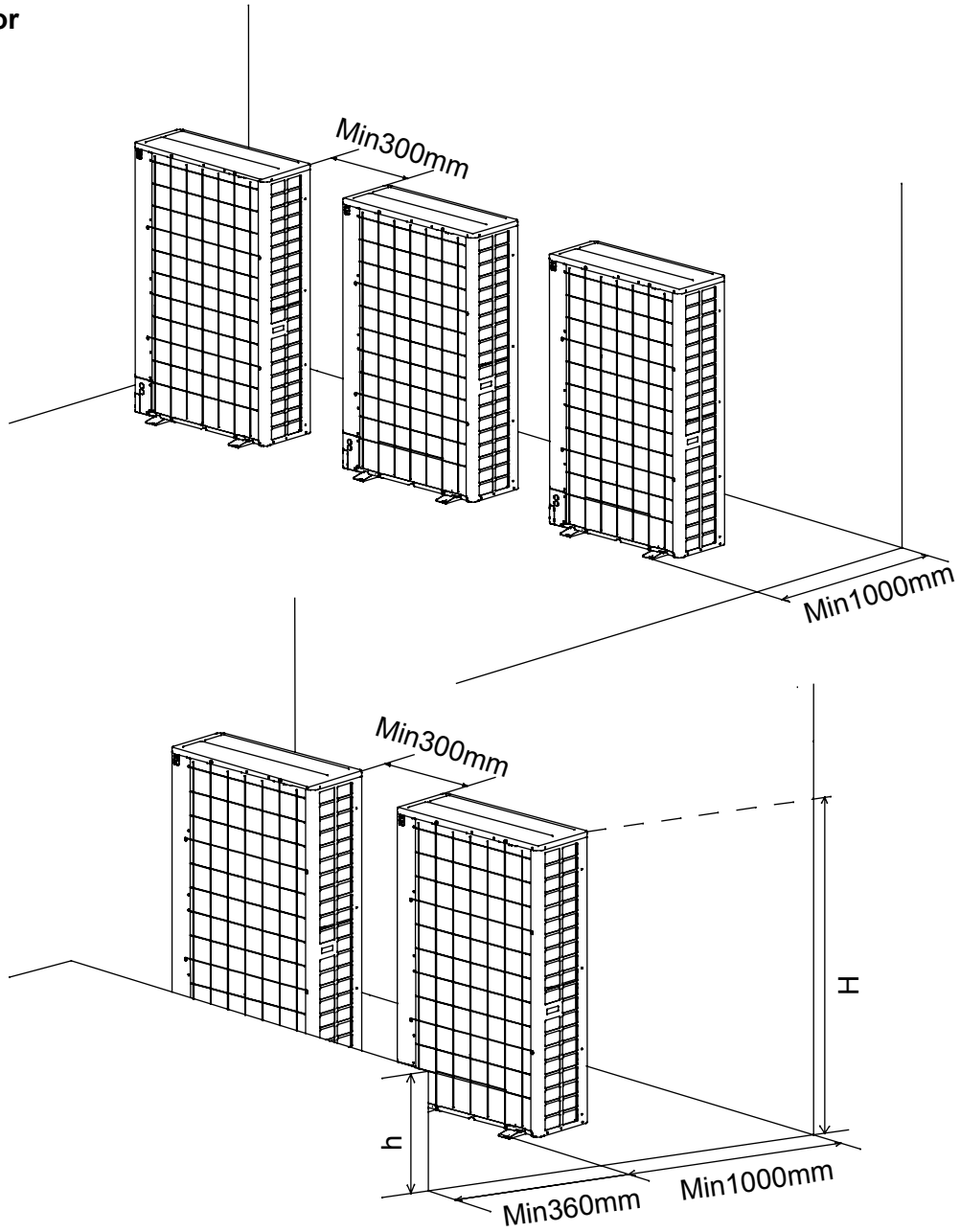

If $h > H$, please set the outdoor on the foundation to make sure $H \geq h$.
 H = The height of outdoor and foundation

h	A
$0 < h \leq 1/2H$	Over 600
$1/2H < h \leq H$	Over 1400

Note:

- Avoid making air short cycle in any case.

Multi Row Outdoor

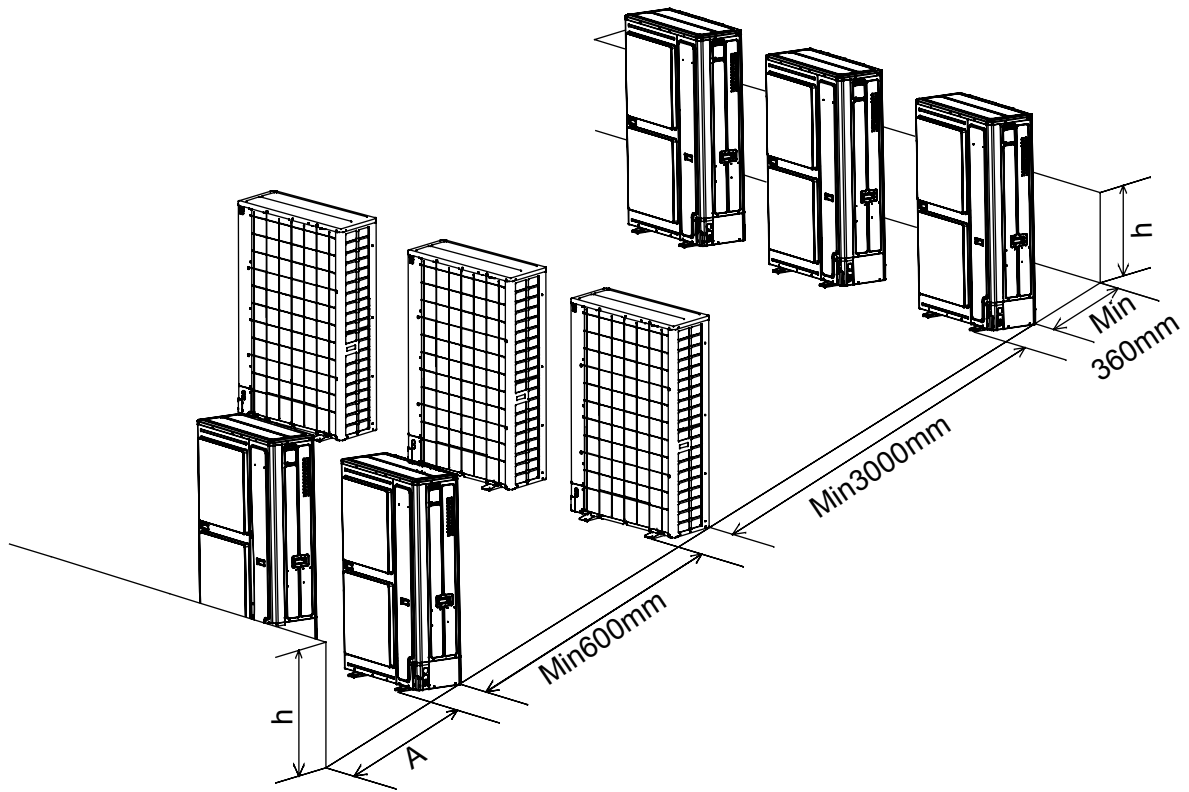

Note:

- Make sure the distance at least 300mm between two neighbor units and no stumbling block.

h	A
$0 < h \leq 1/2H$	Over 600
$1/2H < h \leq H$	Over 1400

A. Refrigerant pipe connection

Pipe connection method

- To ensure the efficiency, the pipe should be as short as possible.
- Daub the refrigerant oil on the connector and the flare nut.
- When bending the pipe, the bending semi-diameter should be as large as possible against the pipe being broken or bent.
- When connecting the pipe, aim at the center to thread the nut by hand and tighten it with the double spanners.
- Fastening torque please refers to "pipe specs and fastening torque" on page 15.
- Don't let the impurity such as sand, water etc into the pipe. Antifouling measures refer to page 13.

- When fastening and loosening the nut, operate with double spanners, because only one spanner cannot execute firmly.

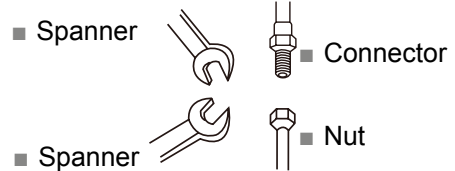

- If threading the nut as not aiming at the center, the screw thread will be damaged, further it will cause leakage.

Cautions in piping installation:

- When welding the pipe with hard solder, charge nitrogen into the pipe against oxidation. The pressure gauge should be set at 0.02 MPa. Perform the procedure with nitrogen circulation. Otherwise, the oxide film in the pipe may clog the capillary and expansion valve resulting in accident.
- The refrigerant pipe should be clean. If the water and the other impurity enter the pipe, charge the nitrogen to clean the pipe. The nitrogen should flow under the pressure of about 0.5Mpa and when charging the nitrogen, stop up the end of the pipe by hand to enhance the pressure in the pipe, then loose the hand (meanwhile stop up the other end).
- The piping installation should be executed after the stop valves are closed.
- When welding the valve and the pipe, cool down the valve with wet towel.
- When the connection pipe and the branch pipe need to be cut down, please use the special shears and cannot use the saw.
- When welding copper pipe, use the phosphor copper welding rod without any welding flux.
- (welding flux will damage the piping system. The welding flux containing chlorine will corrode pipe, especially, the welding flux with fluorin will damage refrigeration oil.)

Pipe material and specs selection

- Please select the refrigerant pipe of the below material.
- Material: the phosphoric oxidize seamless copper pipe, model: C1220T-1/2H (diameter is over 19.05); C1220T-0 (diameter is below 15.88).
- Thickness and specs:
- Confirm the pipe thickness and specs according to the pipe selection method (the unit is with R410A, if the pipe over 19.05 is 0-type, the pressure preservation will be bad, thus it must be 1/2H type and over the min. thickness.)
- The branch pipe and the gather pipe must be from Airwell.
- When installing the stop valve, refer to the relative operation instruction.
- The pipe installation should be in the allowable range.
- The installation of branch pipe and gather pipe should be performed according to the relative manual.

Anti-fouling measures

First, clean the pipe.

Position	Installation period	Measures
Outdoor	More than 1 month	Flat the pipe end
	Less than 1 month	Flat the pipe end or seal with adhesive tape
Indoor	Nothing to do with period	adhesive tape

Pipe specification

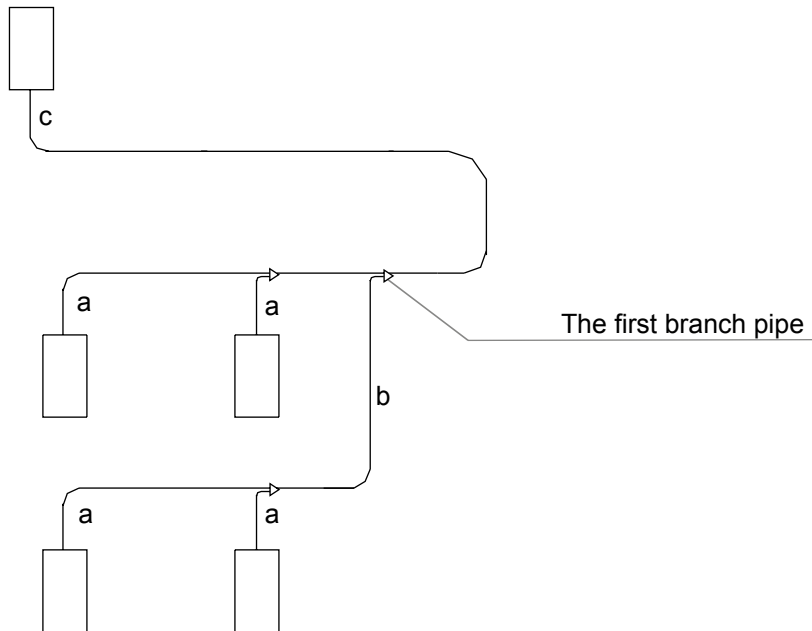

1. Pipe a (indoor-branch pipe) diameter: decided by connected indoor capacity

Indoor rated capacity (x100w)	Gas pipe	Liquid pipe	Note
15~28	9.52	6.35	AS07/092MGERA gas pipe should be 12.7 AS182MGERA gas / liquid pipe should be 15.88 / 9.52
36~56	12.7	6.35	
71~140	15.88	9.52	
226~300	25.4	9.52	
450~600	28.58	12.7	

(1) When pipe length between indoor & nearest branch pipe $\geq 15\text{m}$, adjust in accordance with following criteria:

- ① If indoor rated capacity $\leq 5.6\text{kW}$, change gas / liquid pipe diameter to 15.88 / 9.52
- ② If $16.8\text{kW} \geq$ indoor rated capacity $> 5.6\text{kW}$, change gas / liquid pipe diameter to 19.05 / 9.52
- ③ If indoor rated capacity $> 16.8\text{kW}$, change liquid pipe diameter to 12.7

2. Pipe b (between branch pipes) diameter:

Total capacity of connected indoors	Gas pipe	Liquid pipe	(1) Select in accordance with total capacity connected (2) Pipe b diameter should not be bigger than main pipe c If pipe b diameter is larger than main pipe c, please correct diameter according to either of the following rules: ① Reduce b diameter to be the same as pipe c ② Enlarge main pipe c diameter to be the same as pipe b. (3) If pipe b diameter smaller than pipe a, the pipe b diameter must be enlarged.
$x < 16.8\text{kw}$	15.88	9.52	
$16.8\text{kw} \leq x < 22.4\text{kw}$	19.05	9.52	
$22.4\text{kw} \leq x < 33\text{kw}$	22.22	9.52	
$33\text{kw} \leq x < 47\text{kw}$	28.58	12.7	
$47\text{kw} \leq x < 71\text{kw}$	28.58	15.88	
$71\text{kw} \leq x < 104\text{kw}$	31.8	19.05	
$104\text{kw} \leq x < 154\text{kw}$	38.1	19.05	
$154\text{kw} \leq x < 182\text{kw}$	41.3	19.05	
$x \geq 182\text{kw}$	44.5	22.22	

3. Main pipe c (between outdoor gather pipe & the first branch pipe) diameter:

Outdoor horse power	Main pipe		Enlarged main pipe	
	Gas pipe	Liquid pipe	Gas pipe	Liquid pipe
8HP	19.05	9.52	22.22	12.7
10HP	22.22	12.7	25.4	15.88
12HP	25.4	12.7	28.58	15.88

When the farthest length (between outdoor & the farthest indoor) is over 90m (equivalent length), the main pipe must be enlarged one size.

Copper pipe selection:

Material	O type pipe: Soft pipe			
Pipe diameter (mm)	Ø6.35	Ø9.52	Ø12.7	Ø15.88
Thickness (mm)	0.8	0.8	1.0	1.0

Material	Hard pipe				
Pipe diameter (mm)	Ø19.05	Ø22.22	Ø25.4	Ø28.58	Ø31.8
Thickness (mm)	1.0	1.0	1.0	1.0	1.1

Long pipe and high drop

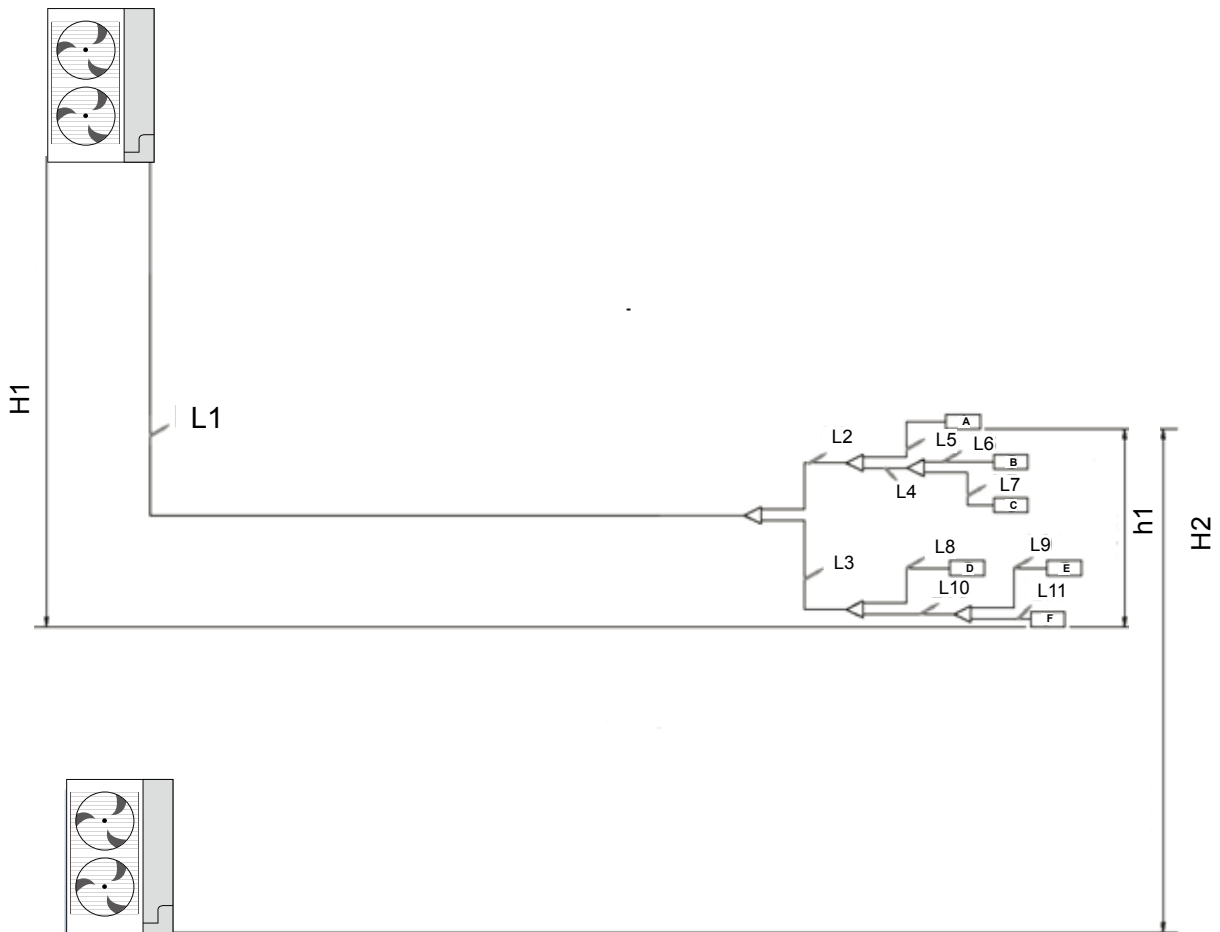

		Length	Pipe in above figure
Single way total pipe length (=total liquid pipe length)		300m	$L1+L2+L3+L4+L5+L6+L7+L8+L9+L10+L11$
Single way max. pipe length (max. length between outdoor & indoor) actual length		150m	$L1+L3+L10+L11$
Main pipe actual length (length between first gather pipe & first branch pipe)		110m	L1
Max. pipe length after first branch pipe (length between first branch & farthest indoor)		40m	$L3+L10+L11$
Pipe length between the indoor unit & the nearest branch length		10m	$L5+L6+L7+L8+L9+L10+L11$
Max. height difference between indoor and outdoor	Outdoor is upper	50m	H1
	Outdoor is lower	40m	H2
Max. height difference between indoors		15m	h1

Unit pipe spec and connection method (unit: mm)

A. Outdoor Unit

Model	Gas pipe side		Liquid pipe side	
	Diameter (mm)	Connecting method	Diameter (mm)	Connecting method
AWAU-YCVFD220-H13	Ø19.05	Flared joint	Ø9.52	Flared joint and Brazing (here including two connecting methods because of using a reducer pipe)
AWAU-YCVFD280-H13	Ø22.22	Flared joint and Brazing (here including two connecting methods because of using a reducer pipe)	Ø12.7	
AWAU-YCVFD335-H13	Ø25.4			Ø12.7

B. Indoor Unit

Model Capacity	Gas pipe side		Liquid pipe side	
	Diameter (mm)	Connecting method	Diameter (mm)	Connecting method
05	Ø9.52	Flared	Ø6.35	Flared
07	Ø9.52		Ø6.35	
09	Ø9.52		Ø6.35	
12	Ø12.7		Ø6.35	
16	Ø12.7		Ø6.35	
18	Ø12.7		Ø6.35	
24	Ø15.88		Ø9.52	
28	Ø15.88		Ø9.52	
30	Ø15.88		Ø9.52	
38	Ø15.88		Ø9.52	
48	Ø15.88		Ø9.52	
72	Ø25.4	Braze	Ø9.52	
96	Ø25.4		Ø9.52	

C. Pipe spec and the torque

Diameter (mm)	Torque (N.m)
Ø6.35	14~18
Ø9.52	34~42
Ø12.7	49~61
Ø15.88	68~82
Ø19.05	84~98

Branch pipe

Branch pipe selection:

Total indoor capacity (100W)	Model (optional)
Less than 335	TAU335
More than 335, less than 506	TAU506

Outdoor unit type

The master unit will choose the closest one to the 1st branch pipe.

Note:

- When connecting the outdoor branch pipe and the outdoor, please pay attention to the outdoor pipe dimension.
- When adjusting the diameter among outdoor branch pipe and among the units, please must execute at the branch pipe side.
- Please install the outdoor branch pipe (gas/liquid side) in horizontal or vertical direction.
- When welding with hard solder, please must blow nitrogen. If not, a number of oxide will be produced and cause heavy damage. Besides, to prevent water and dust into the pipe, please make the brim as outer roll.

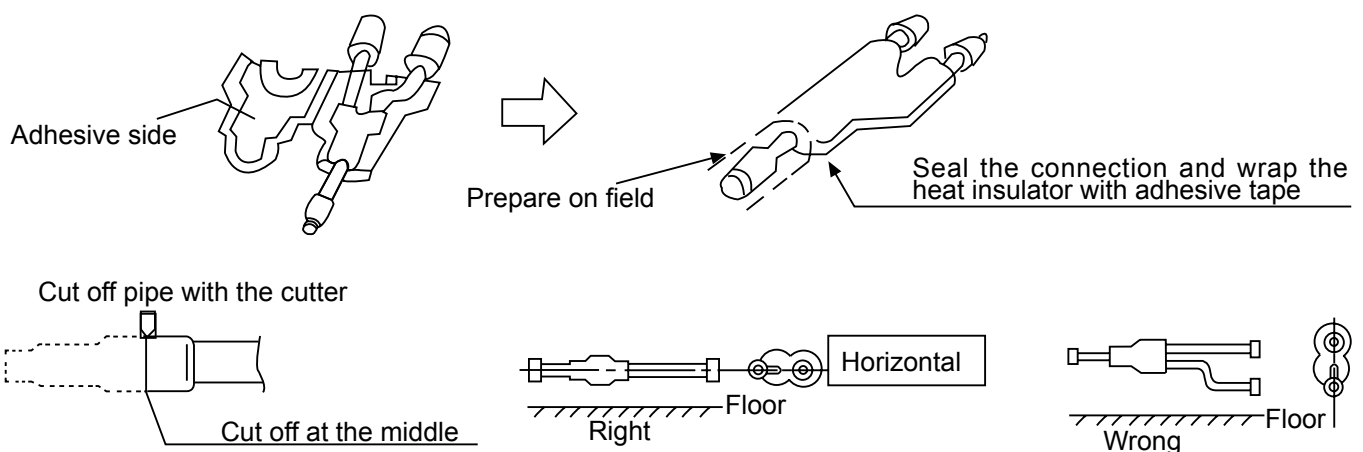

Pipe installation

When doing the piping connection, please do the following:

- Please don't let the pipe and the parts in the unit collide each other.
- When connecting the pipes, close the valves fully.
- Protect the pipe end against the water, impurity into the pipes (welding after being flat, or being sealed with adhesive tape).
- Bend the pipe as large semi-diameter as possible (over 4 times of the pipe diameter).
- The connection between outdoor liquid pipe and the distributing pipe is flared type. Please expand the pipe with the special tool for R410A after installing the expanding nut. But if the projecting pipe length has been adjusted with the copper pipe gauge, you can use the original tool to expand the pipe.
- Since the unit is with R410A, the expanding oil is ester oil, not the mineral oil.
- When doing the flare connection, please do the following: When connecting the expanding pipe, fasten the pipes with double-spanner. The torque refers to the former info.

■ Expanding pipe: A (mm)

■ Projecting length of pipe to be expanded: B (mm)

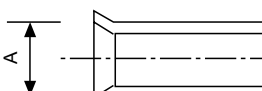

Pipe outer diameter (mm)	A
Ø6.35	9.1
Ø9.52	13.2
Ø12.7	16.6
Ø15.88	19.7

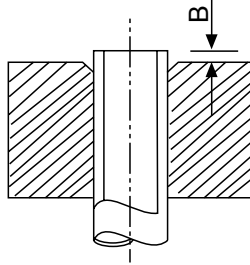

Pipe outer diameter (mm)	When it is hard pipe	
	Special tool for R410A	The former tool
Ø6.35	0-0.5	1.0-1.5
Ø9.52		
Ø12.7		
Ø15.88		

- The outdoor gas pipe and the refrigerant distributing pipe, as well the refrigerant distributing pipe and the branch pipe should be welded with hard solder.
- When doing the braze connection, please do the following: Brazing the pipe at the same time charge the nitrogen. Or it will cause a number of impurity (a film of oxidation) to clog the capillary and the expansion valve, further cause the deadly failure.

Operation procedure

- Brazing the pipe at the same time charge the nitrogen. Or it will cause a number of impurity (a film of oxidation) to clog the capillary and the expansion valve, further cause the deadly failure.

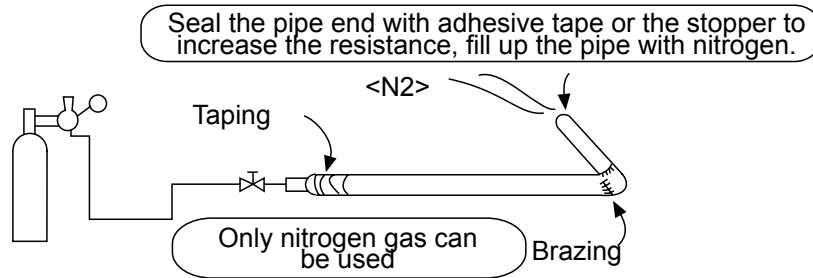

- Protect the pipe end against the water, impurity into the pipes (welding after being flat, or being sealed with adhesive tape).

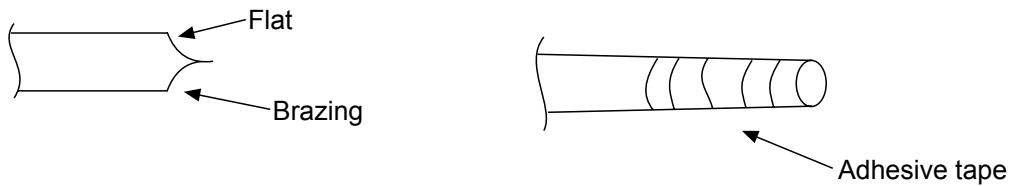

- The refrigerant pipe should be clean. The nitrogen should flow under the pressure of about 0.5Mpa and when charging the nitrogen, stop up the end of the pipe by hand to enhance the pressure in the pipe, then loose the hand (meanwhile stop up the other end).

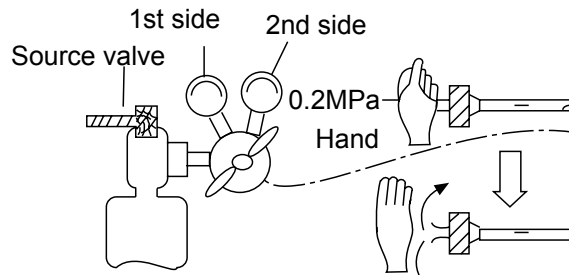

- When connecting the pipes, close the valves fully.
- When welding the valve and the pipes, use the wet cloth to cool down the valve and the pipes.

B. Leakage test

- The outdoor unit has been executed the leakage test in the factory. The pipe should be executed leakage test individually and forbidden to test after connecting with stop valve.
- Refer to the below figure to charge the nitrogen into the unit to take a test. Never use the chlorine, oxygen, flammable gas in the leakage test. Apply pressure both on the gas pipe and the liquid pipe.
- Apply the pressure step by step to the target pressure.
 - a. Apply the pressure to 0.5MPa for more than 5 minutes, confirm if pressure goes down.
 - b. Apply the pressure to 1.5MPa for more than 5 minutes, confirm if pressure goes down.
 - c. Apply the pressure to the target pressure (4.15MPa), record the temp. and the pressure.
 - d. Leave it at 4.15MPa for over 1 day, if pressure does not go down, the test is passed.
- Meanwhile, when the temp. changes for 1degree, pressure will change 0.01MPa as well.
- Correct the pressure.
- e. After confirmation of a~d, if pressure goes down, there is leakage. Check the brazing position, flared position by laying on the soap. Modify the leakage point and take another leakage test.
- After leakage test, must execute the evacuation.

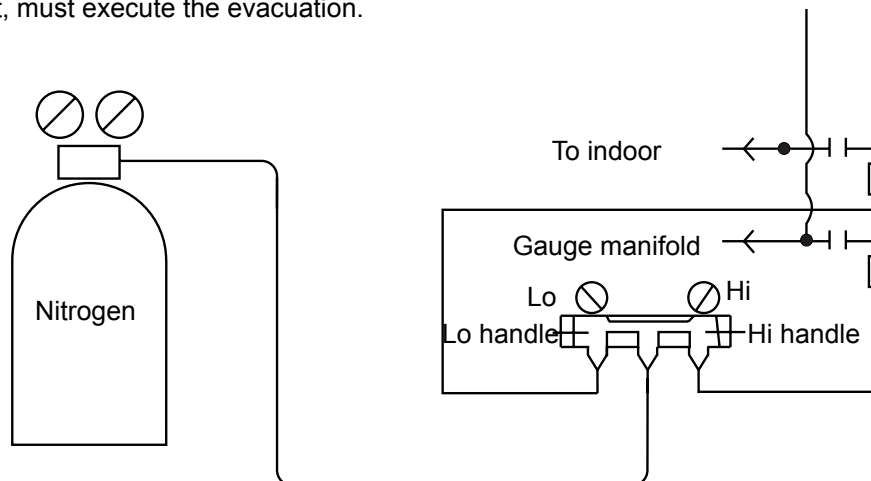

C. Evacuation

Evacuate at the check valve of liquid stop valve and both sides of the gas stop valve. The oil equalization pipe also must be vacuum (executed at the oil equalization pipe check valve respectively).

Operation procedure:

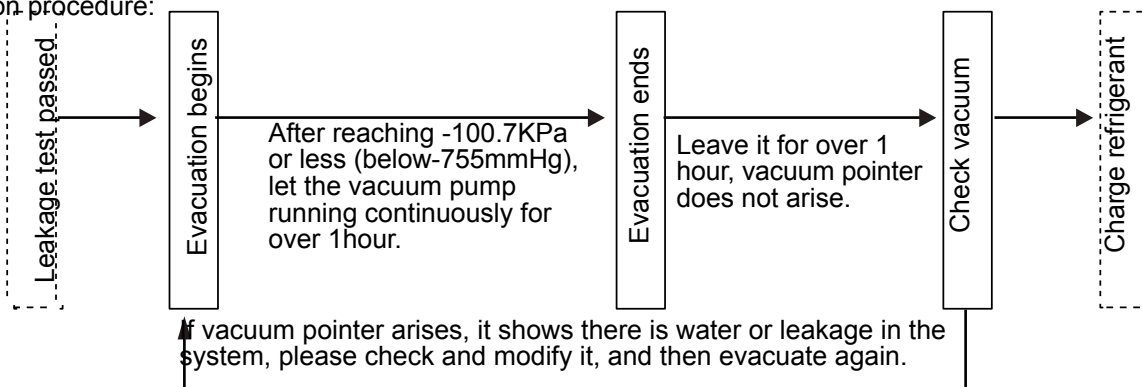

Because the unit is with refrigerant R410A, the below issues should be paid attention:

- To prevent the different oil into the pipe, please use the special tool for R410A, especially for gauge manifold and charging hose.
- To prevent the compressor oil into the refrigerant cycle, please use the anti-counter-flow adapter.

D. Check valve operation

Open/close method:

- Take down the valve cap, gas pipe turns to "open" state as right figure.
- Turn the liquid pipe with hexangular spanner until it stops. If opening the valve strongly, the valve will be damaged.
- Tighten the valve cap.

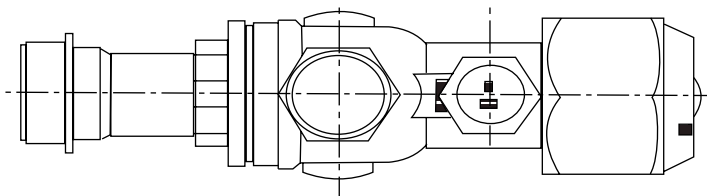
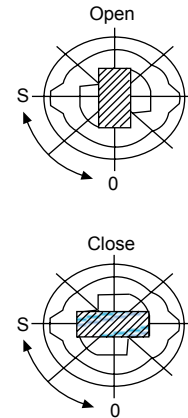

Tighten torque as the table below:

Tighten torque N·m			
	Shaft (valve body)	Cap (cover)	T-shape nut (check joint)
For gas pipe	8~9	22~27	8~10
For liquid pipe	5~6	13~16	8~10

E. Additional refrigerant charging

Charge the additional refrigerant as liquid state with the gauge.

If the additional refrigerant can not be charged totally when the outdoor stops, charge it at the trial mode.

If the unit runs for a long period in the state of lack of refrigerant, compressor will occur failure.

(the charging must be finished within 30 minutes especially when the unit is running, meanwhile charging the refrigerant).

The unit is charged only part of the refrigerant at the factory, also need additional refrigerant at the installation site.

W1: Refrigerant charging volume to outdoor unit at factory.

W2: Refrigerant charging volume to outdoor unit on site.

W3: Refrigerant charging volume to liquid pipe base on different piping length calculation.

W3=actual length of liquid pipe×additional amount per meter liquid pipe

$$=L1 \times 0.35 + L2 \times 0.25 + L3 \times 0.17 + L4 \times 0.11 + L5 \times 0.054 + L6 \times 0.022$$

L1: Total length of 22.22 liquid pipe;

L2: Total length of 19.05 liquid pipe;

L3: Total length of 15.88 liquid pipe;

L4: Total length of 12.7 liquid pipe;

L5: Total length of 9.52 liquid pipe;

L6: Total length of 6.35 liquid pipe;

Total refrigerant volume charging on site during installation=W2+W3

W: Total refrigerant volume charging on site for maintenance.

Refrigerant record form						
Model	W1: Refrigerant charging volume to outdoor unit at factory	W2: Refrigerant charging volume to outdoor unit on site	W3: Refrigerant charging volume to liquid pipe base on different piping length calculation		Total refrigerant volume charging on site during installation	W: Total refrigerant volume charging on site for maintenance
			Liquid pipe diameter (mm)	Additional refrigerant amount (kg)		
AWAU-YCVFD220-H13	6.1kg	0kg	Ø6.35	0.022kg/m×__m=__kg	W2+W3= __kg	W1+W2+W3= __kg
AWAU-YCVFD280-H13		0kg	Ø9.52	0.054kg/m×__m=__kg		
AWAU-YCVFD335-H13		0kg	Ø12.7	0.11kg/m×__m=__kg		
			Ø15.88	0.17kg/m×__m=__kg		
			Ø19.05	0.25kg/m×__m=__kg		
			Ø22.22	0.35kg/m×__m=__kg		
			W3= __kg			

Note:

- To prevent the different oil into the pipe, please use the special tool for R410A, especially for gauge manifold and charging hose.
- Mark the refrigerant type in different colour on the tank. R410A is pink.
- Must not use the charging cylinder, because the R410A will change when transferring to the cylinder.
- When charging refrigerant, the refrigerant should be taken out from the tank as liquid state.
- Mark the counted refrigerant volume due to the distributing pipe length on the label.

Heat insulation

- Gas pipe and liquid pipe should be heat insulated separately.
- The material for gas pipe should endure the high temperature over 120°C.
- That for liquid pipe should be over 70°C.
- The material thickness should be over 10mm, when ambient temp. is 30°C, and the relative humidity is over 80%, the material thickness should be over 20mm.
- The material should cling the pipe closely without gap, then be wrapped with adhesive tape. The connection wire can not be put together with the heat insulation material and should be far at least 20cm.

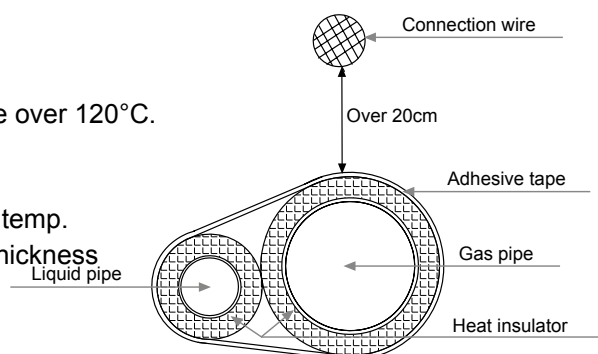

Fix the refrigerant pipe

- In operation, the pipe will vibrate and expand or shrink. If not being fixed, the refrigerant will focus on one part to cause the broken pipe.
- To prevent the central stress, fix the pipe for every 2-3m.

9. Electric Installation

Communication wiring figure

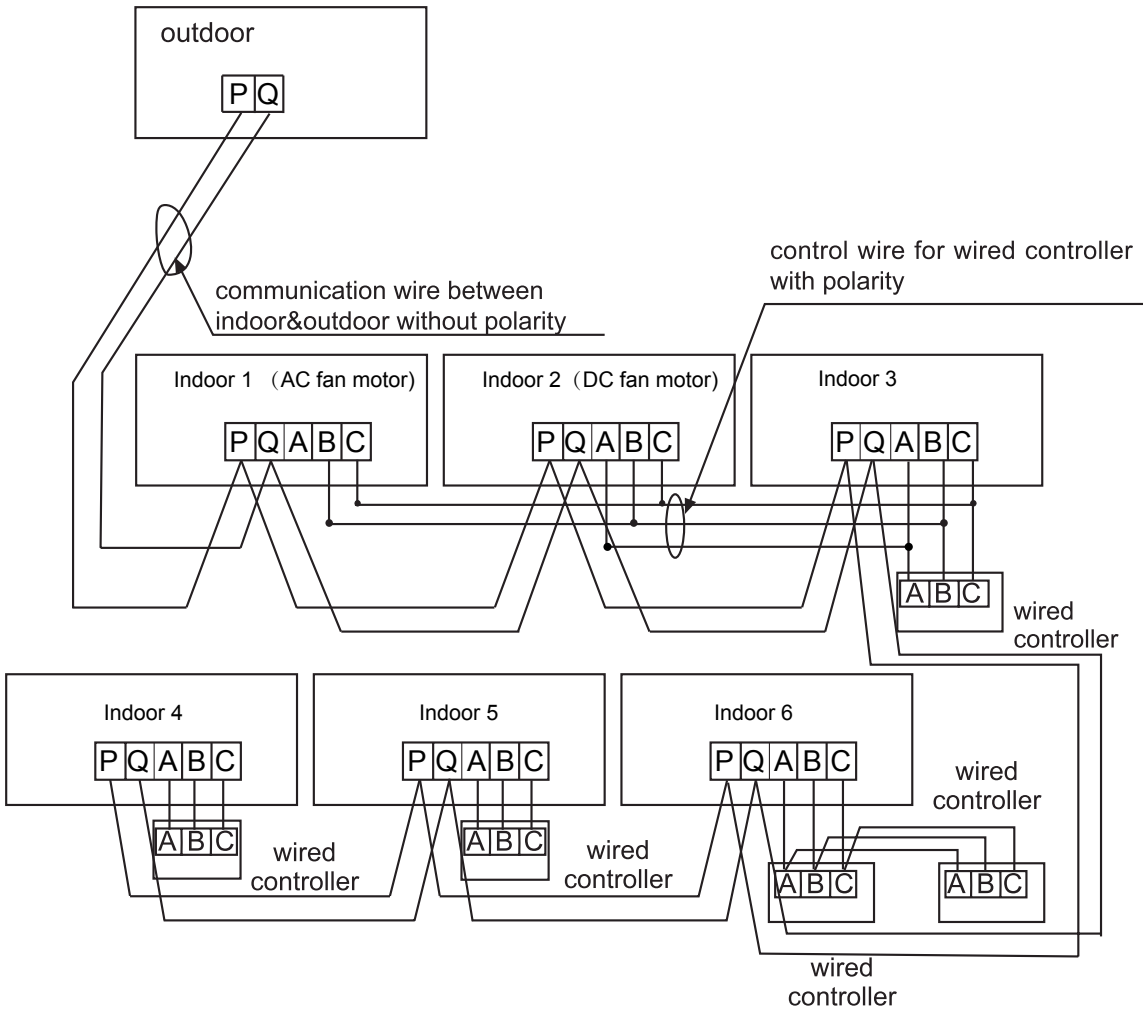

The master outdoor and all indoor units are in parallel through 2 non-polar wires.

There are three connecting ways between wired control and indoor units:

- A. One wired controller controls multiple units, as shown in the above figure, (1-3 indoor units). The indoor unit 3 is the wired control master unit (directly connected to the indoor unit of wired controller) and others are the wired control slave units. indoor unit 2 is DC fan motor models, indoor unit 1 is the AC fan motor models. The wired controller is connected with the master unit and DC fan motor models through three lines with polarity. Other indoor units and the master unit are connected via two lines with polarity. SW01 on the main unit is set to 0 while SW01 on other slave units are set to 1, 2, 3 and so on in turn. (Please refer to the dip switch setting)
- B. One wired controller controls one indoor unit, as shown in the above figure (indoor unit 4-5). The indoor unit and the wired controller are connected via three lines with polarity.
- C. Two wired controllers control one indoor unit, as shown in the figure (indoor unit 6). Either of the wired controllers can be set to be the master wired control while the other is set to be the slave wired controller. The master wired controller, slave wired controller and indoor units are connected via three lines with polarity.

Type	Series	Model	PCB Code
AC fan motor	4-way Cassette	AWSI-CCV*-N11	0151800113
	2-way Cassette	AWSI-CEV*-N11	0151800161B
	Convertible	AWSI-FAV*-N11	0151800113
	Slim Low ESP Duct	AWSI-DDV*-N11	0151800161C
	Medium ESP Duct	AWSI-DBV*-N11	0151800113
		AW-DBV*-N11	0151800161C
	High ESP Duct	AWSI-DCV*-N11	0151800113
DC fan motor	Round Flow 4-Way Cassette	AWSI-CFV*-N11	0151800227
	Mini 4-Way Cassette	AWSI-CCV*-N11	0151800244BA
	One Way Cassette	AWSI-CDV*-N11	0151800244BA
	DC Slim Low ESP Duct	AWSI-DDV*-N11	0151800244
	N Plate High Wall	AWSI-HBV*-N11	0151800244B

Power wiring figure

- Please make sure that when the unit is running, the input voltage is no less than 380V; if it is lower than 380V, the unit may run abnormal.

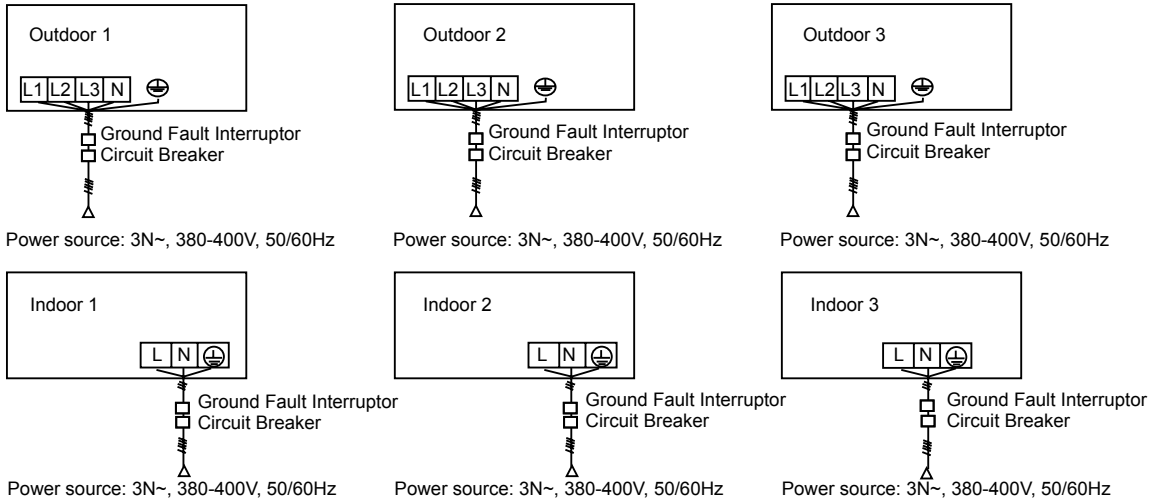

- Indoor and outdoor use their individual power source.
- All indoors use one power source.
- Must install the leakage breaker and the over current breaker, or electric shock will occur.

Outdoor power source and power cable

Item		Power source	Power cable section (mm ²)	Wire length (m)	Circuit breaker (A)	Rated current of residual circuit breaker (A) Ground fault interruptor (mA) Response time (S)	Ground wire	
							Section (mm ²)	Screw
Model								
Individual power	AWAU-YCVFD220-H13	3N~, 380-400V, 50/60 Hz	6	20	40	40A 30mA below 0.1S	3.5	M5
	AWAU-YCVFD280-H13		10	20	40	40A 30mA below 0.1S	3.5	M5
	AWAU-YCVFD335-H13		10	20	40	40A 30mA below 0.1S	3.5	M5

- Power cable must be fixed firmly.
- Each outdoor must be earthed well.
- When power cable exceeds the range, thicken it appropriately.

Indoor power source and communication wiring

Item Indoor total current (A)	Power cable section (mm ²)	Wire length (m)	Rated current of overcurrent breaker (A)	Rated current of residual circuit breaker (A) Ground fault interruptor (mA) Response time (S)	Communication wire section	
					Outdoor/indoor (mm ²)	Indoor/indoor (mm ²)
<10	2	20	20	20A, 30mA, below 0.1s	2-core×(0.75-2.0mm ²) shielded wire	
≥10 and <15	3.5	25	30	30A, 30mA, below 0.1s		
≥15 and <22	5.5	30	40	40A, 30mA, below 0.1s		
≥22 and <27	10	40	50	50A, 30mA, below 0.1s		

- Power cable and communication wire must be fixed firmly.
- Each indoor must be grounded well.
- When power cable exceeds the range, increase the gauge appropriately.
- Shielded layer of communication wires must be connected together and be earthed at single point.
- Communication wire total length cannot exceed 1000m.

Communication wire for wired controller

Wire length (m)	Wire spec
≤250	0.75mm ² ×(3-core) shielded wire

- Shielded layer of communication wire must be grounded at one end.
- The total length cannot exceed 250m.

10. Trial Operation

5-minute delay function

- If starting up the unit after being powered off, the compressor will run about 5 minutes later against being damaged.

Cooling/heating operation

- Indoor units can be controlled individually, but cannot run in cool and heat mode at the same time. If the cool mode and the heat mode are existing simultaneously, the unit set latter will be standby, and the unit set earlier will run normally.
- If the A/C manager sets the unit at cooling or heating mode fixedly, the unit can not run at the other modes.

Heating mode characteristic

- In operation if outdoor temp. arises, indoor fan motor will turn to low speed or stop.

Defrosting in heating mode

- In heating mode, outdoor defrosting will affect the heating efficiency. The unit will defrost for about 2~10 minutes automatically, at this time, the condensate will flow from outdoor, also in defrosting, the vapour will appear at outdoor, which is normal. Indoor motor will run at low speed or stop, and outdoor motor will stop.

The unit operation condition

- To use the unit properly, please operate the unit under the allowed condition range. If operating beyond the range, the protection device will act.
- The relative humidity should be lower than 80%. If the unit runs at the humidity over 80% for a long period, the dew on the unit will drop down and the vapour will be blown from air outlet.

Protection device (such as high pressure switch)

- High pressure switch is the device which can stop the unit automatically when the unit runs abnormally. When the high pressure switch acts, the cooling/heating mode will stop but the running LED on wired controller will be light still. The wired controller will display failure code.
- When the following cases occur, the protection device will act:
In cooling mode, air outlet and air inlet of outdoor are clogged.
In heating mode, indoor filter is stucked with duct; indoor air outlet is clogged.
When protection device acts, please cut off the power source and re-start up after eliminating the trouble.

When power failure

- When power is failure in running, all the operations will stop.
- After being electrified again, if with re-start up function, the unit can resume to the state before power off automatically; if without re-start up function, the unit needs to be switched on again.
- When abnormal occurs in running because of the thunder, the lightning, the interference of car or radio, etc, please cut off the power source, after eliminating the failure, press "ON/OFF" button to start up the unit.

Heating capacity

- The heating mode adopts the heat pump type that absorbs outdoor heat energy and releases into indoor. So if outdoor temperature goes down, the heating capacity will decrease.

Trial operation

- Before trial operation:

Before being energized, measure the resistor between power terminal block (live wire and neutral wire) and the grounded point with a multimeter, and check if it is over 1M^{*}. If not, the unit can not operate.

To protect compressor, energize the outdoor unit for at least 12 hours before the unit runs. If the crankcase heater is not energized for 6 hours, the compressor will not work.

Confirm the compressor bottom getting hot.

Except for the condition that there is only one master unit connected (no slave unit), under the other conditions, open fully the outdoor operating valves (gas side, liquid side, oil equalization pipe). If operating the unit without opening the valves, compressor failure will occur.

Confirm all indoor units being electrified. If not, water leakage will occur. Measure the system pressure with pressure gauge, at the same time, operate the unit.

- Trial operation

In trial operation, refer to the information of performance section. When the unit can not start up at the room temperature, make trial operation for outdoor.

1. System marks

On the condition that multi VRF II system are installed, in order to confirm the relationship between outdoor and indoor, please make marks on outdoor electric control box cover to indicate the connected indoor unit. As the below figure:

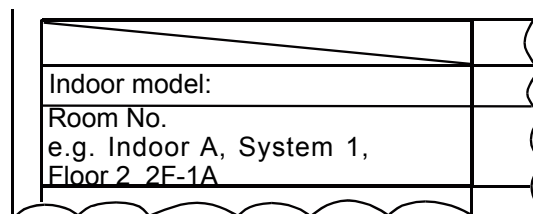

2. Trial operation sequence

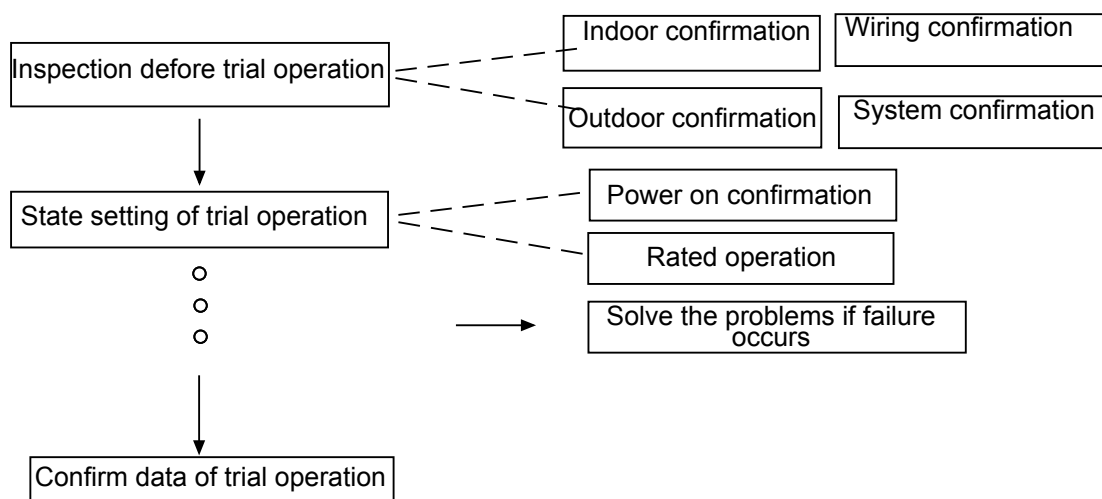

3. Inspection before trial operation

Before inspection, confirm the state of indoor and outdoor to avoid the trial failure because of the incorrect installation.

3.1 Indoor unit confirmation

NO.	Inspection Items	Results
1	If indoor unit is in good condition, and if the electric box position is in accordance with state when out of factory, also if it is fixed firmly.	
2	If indoor wiring is correct.If the connecting terminal of the fan motor, swing motor and water pump is connected well. If the sensor is in good condition and it is at the proper place.	
3	If the dip switch of indoor unit is set correctly. If the indoor address, central controller address, wired controller address and its other selection are correct.	
4	If the wire sequence of wired controller is correct.	
5	Before being electrified, measure the resistors among live wire, neutral wire and earthing point on the terminal block with the 500V ohmmeter. The resistor must be over 1 M Ohm.	

3.2 Outdoor unit confirmation

NO.	Inspection items	Results
1	If outdoor unit is in good condition, and if the electric box is fixed firmly.	
2	If outdoor wiring is correct. If the wires are broken.	
3	If the dip switch of outdoor unit is set correctly. If the outdoor address is correct. The master unit No. must be No.1, and the other units can be No.2, No.3. If there are multiple outdoors, before being electrified, the master unit SW4-5 is set as "searching outdoor".	

3.3 Wiring confirmation

NO.	Inspection Items	Results
1	If outdoor power cable is fixed at correct position. And if the power cable is in compliance with the requirement.	
2	If indoor power cable is fixed at correct position. And if the power cable is in compliance with the requirement.	
3	Check the indoor power wiring to prevent that one of indoors has already powered down, all the other indoors and outdoors in one system ate normally running. Indoors in one system should adopt one power supply.	
4	If the communication wire between outdoors complies with requirement, and A, B, C must be corresponding, or the PCB will be damaged.	
5	If the communication wire between indoor and outdoor complies with requirement, and the communication wires do not care the phase sequence, but the shielded wire is needed. The shielded layer among indoors must be continuous. The communication wire of the whole system must be earthed at the farthest shielded wires of indoor and outdoor.	
6	If the communication wire between indoor and wired controller complies with requirement, and A, B, C must be corresponding, or the wired controller will be abnormal.	
7	The distance between high voltage and low voltage of the power cable and the communication wire must be over 50mm. Or communication failure will occur.	

3.4 System confirmation

Liquid pipe diameter	Standard additional charging amount (kg/m)	Total length of liquid pipe (mm)	Every liquid pipe additional charging amount (kg)
φ6.35	0.022	=	
φ9.52	0.054	=	
φ12.7	0.11	=	
φ15.88	0.17	=	
φ19.05	0.25	=	
φ22.22	0.35	=	
		total additional charging amount	

Note:

- Check if outdoor stop valve has been open fully. When there is only master unit, please confirm if the oil pipe stop valve has been close fully.

4. State setting of trial operation

Confirm being electrified

Indoor and outdoor are electrified respectively and then check as the following table:

NO.	Inspection items	Results
1	If outdoor PCB is electrified; if the communication indicator flashes.	
2	If indoor communication indicator flashes.	
3	Check the indoor running parameters are correct after outdoor is connected the testing board and the testing software, such as the sensor characteristic, the EEV open angle, etc.	

5. Trial operation

Generally, confirm all the indoors one by one. Please set the other indoors at STOP state.

(1) Main power supply and preliminary confirmation

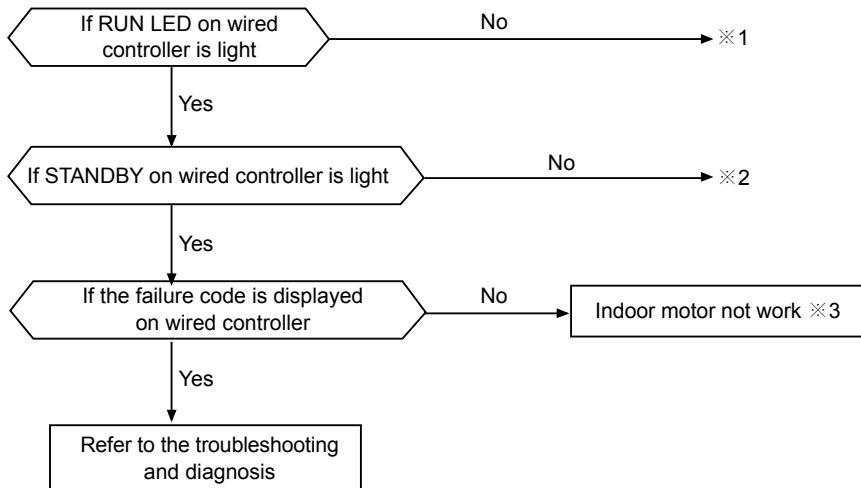

(2) Motor operation confirmation

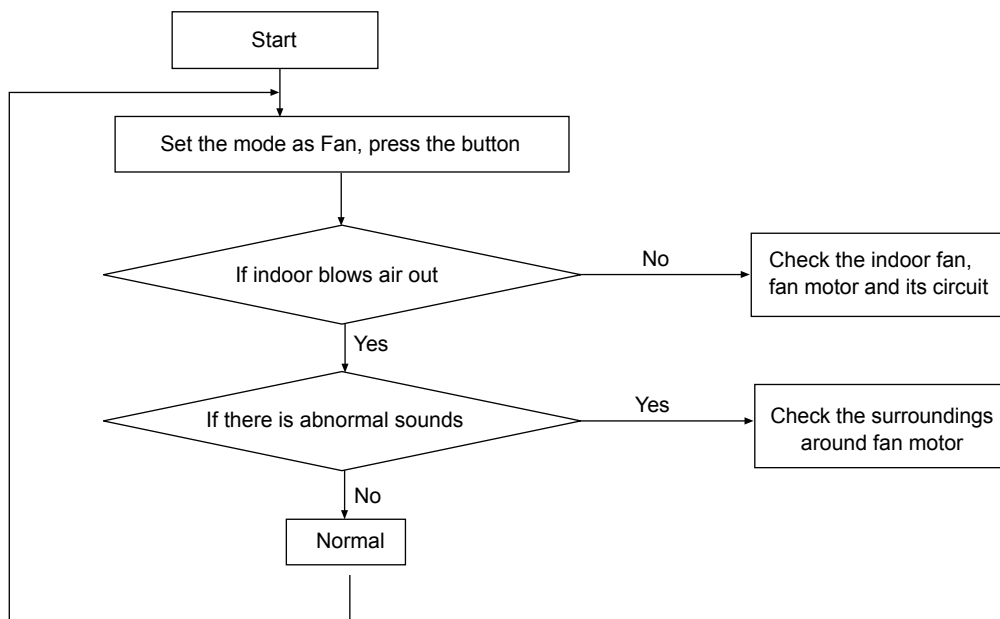

(3) Cooling operation confirmation

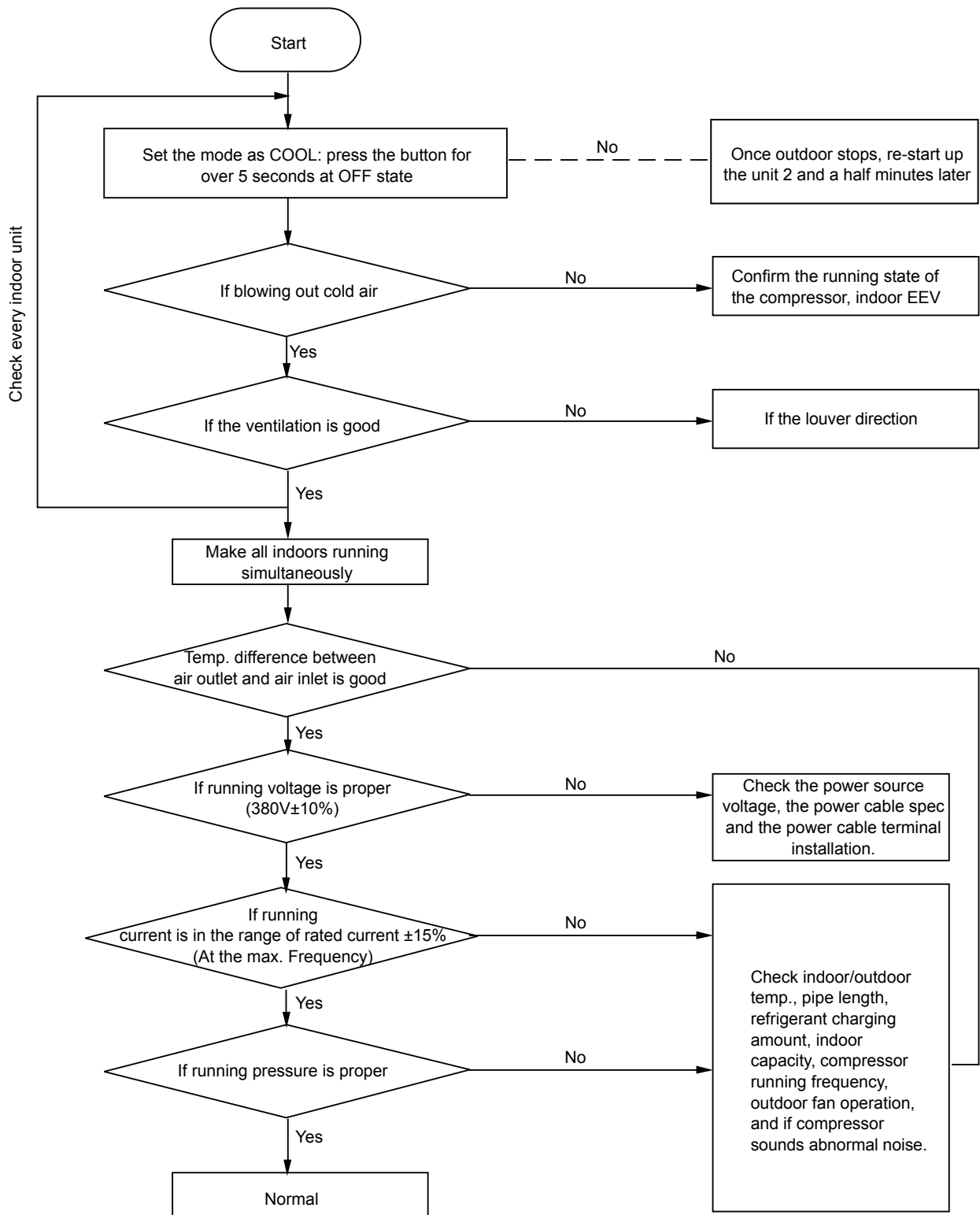

(4) Heating operation confirmation

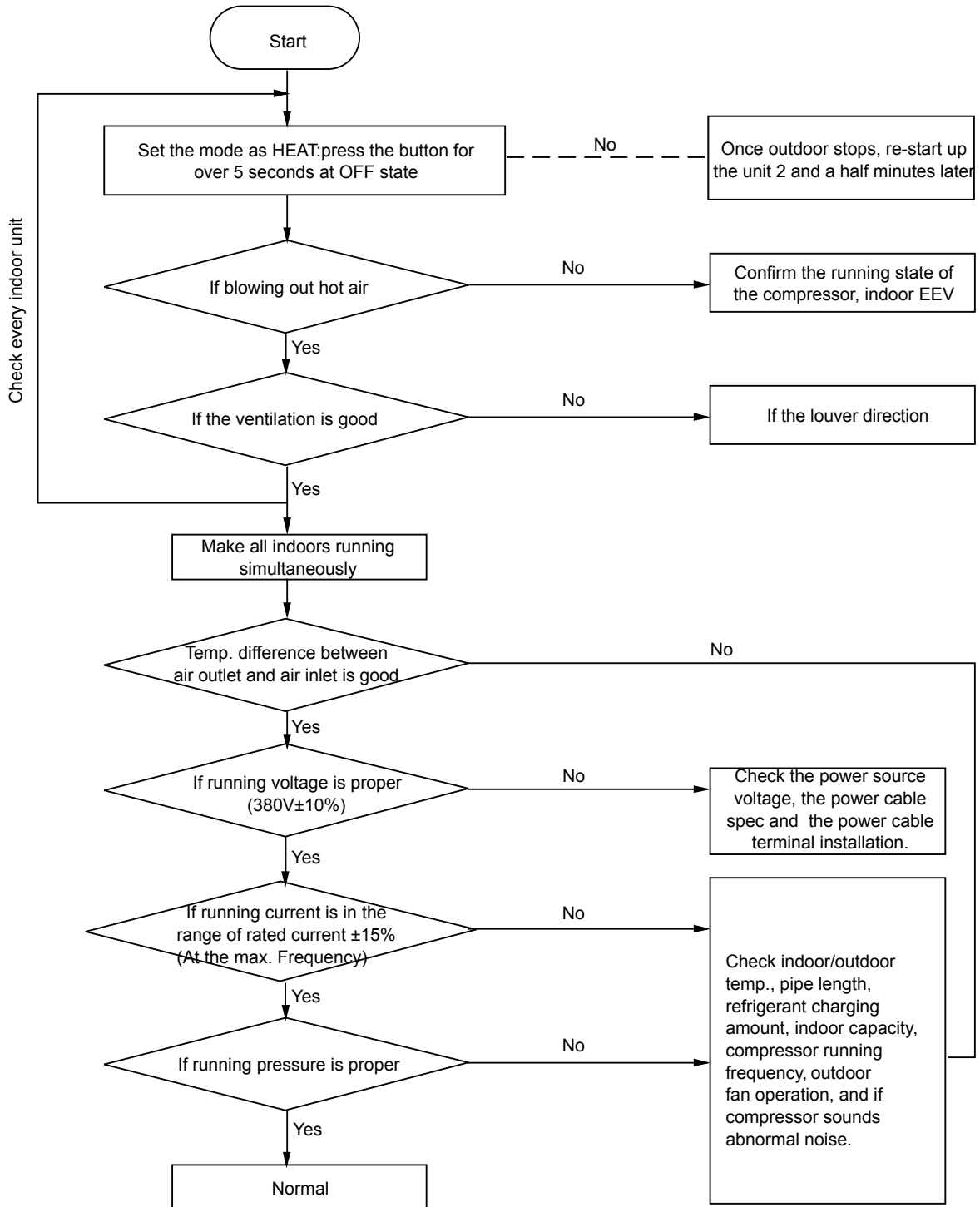

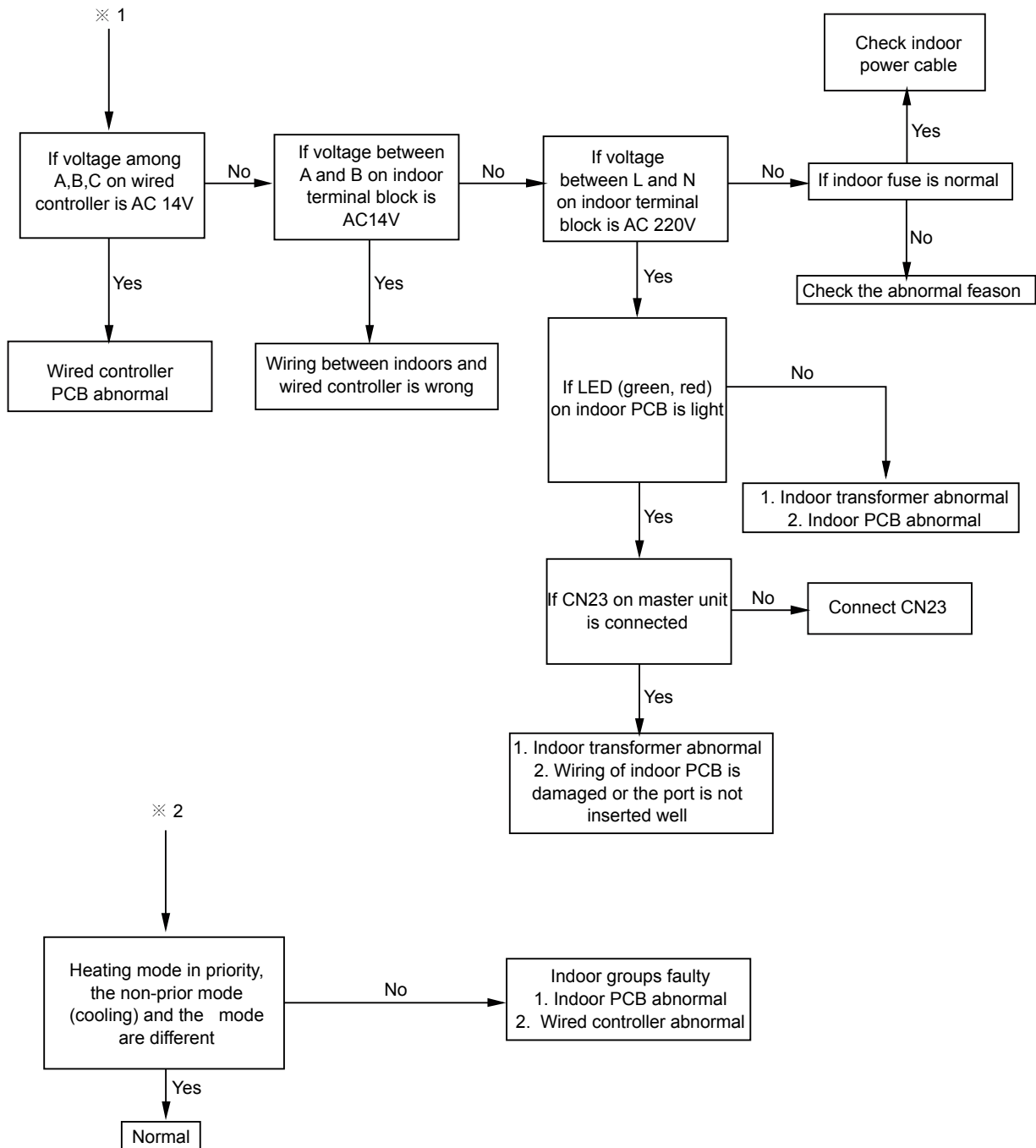

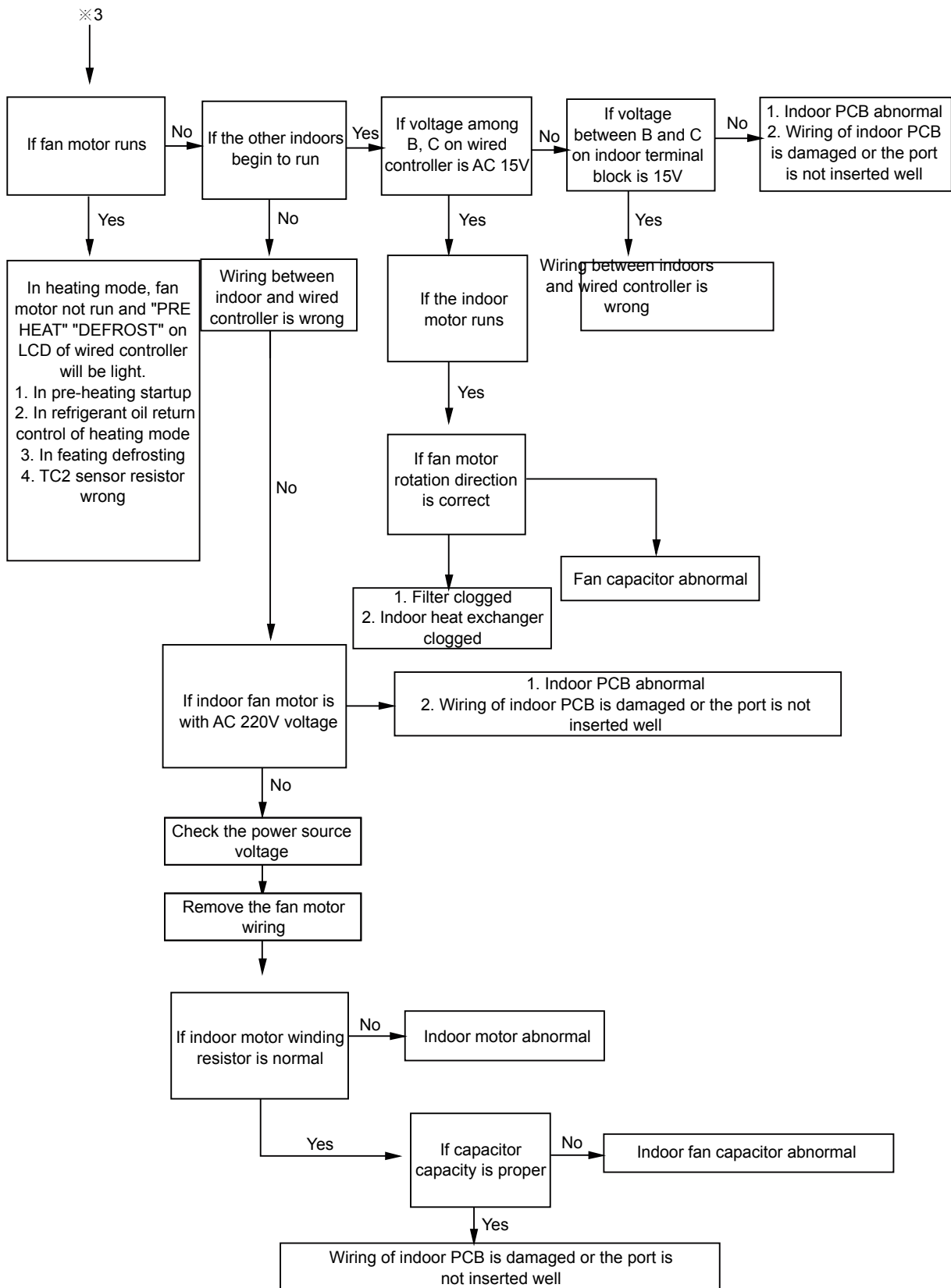

Note 1: Temp. difference between air inlet and air outlet Standard

- A. In cooling mode, after running for at least 30 minutes, it is normal that the temp. difference between air inlet and air outlet is over 10°C, (at max. frequency)
- B. In heating mode, after running for at least 30 minutes, it is normal that the temp. difference between air inlet and air outlet is over 14°C, (at max. frequency).

Note 2: Running current standard

- It is normal that the running current is in the range of rated current 15±% (at max. frequency) . The current will be different for the below condition:
- If more than the rated current: high indoor/outdoor temp. ; outdoor bad ventilation (cooling mode), indoor bad ventilation (heating mode).
- If lower than rated current: low indoor/outdoor temp. ; refrigerant leakage (lack of refrigerant).

Note 3: Running pressure standard

Cooling (at max. frequency)	High pressure 2.0~3.5MPa	Indoor 18~32°C Outdoor 25~35°C
	Low pressure 0.6~1.0MPa	
Heating (at max. frequency)	High pressure 2.2~2.8MPa	Indoor 15~25°C Outdoor 5~10°C
	Low pressure 0.3~0.8MPa	

The above value is measured after running for 15 minutes (ambient temp. is DB(°C))

High/low pressure changing trend due to the running condition:

Cooling/heating:

Indoor temp. goes up---high/low pressure goes up

Indoor temp. goes down---high/low pressure goes down

Outdoor temp. goes up---high/low pressure goes up

Outdoor temp. goes down---high/low pressure goes down

6. Refrigerant automatic recall operating instructions

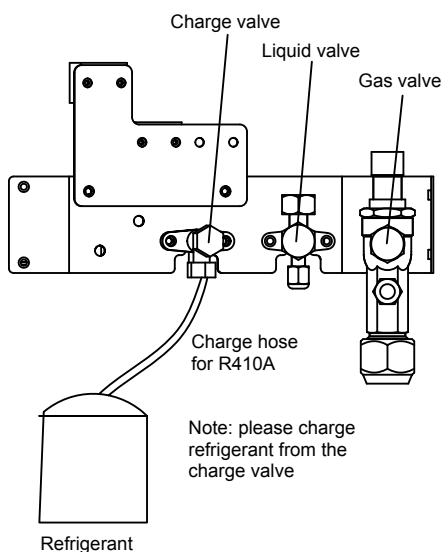

Please according to as follows the operation

1. Press "start+stop" at the same time on the PCB 5 ses,
2. When the digital tube shows C1 alternately gleam with low-pressure pressure, please close liquid valve; When the digital tube shows C2, please close gas valve; The system automatically shuts down after the 5 ses, the digital tube shows C3, please cut the power.

11. Dip Switch Setting

Outdoor PCB photo (code: 0151800146B)

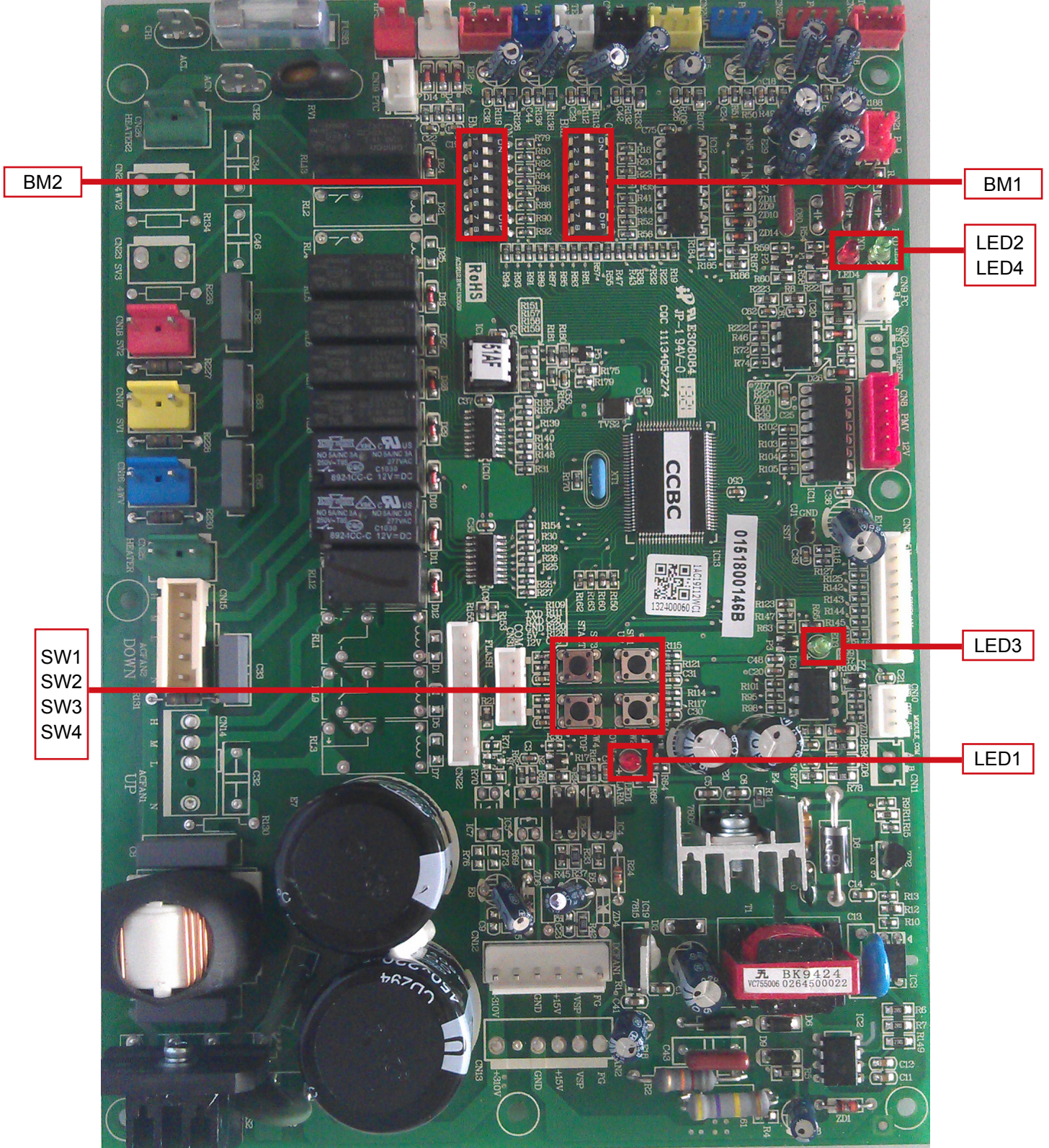

LED light introduction

- LED1,LED3: malfunction lamp of outdoor unit.
This lamp not light under normal condition
- LED2, LED4: communication lamp between indoor units and outdoor units.
These two lamps flicker alternately under normal condition;

Dip switch introduction

BM1 is usually set by the personnel on site; BM2 is usually used in the factory.

BM1 Introduction

BM1	Definition	Introduction		
BM1_1	Indoor unit Qty. lock	OFF	Searching indoor unit	
		<u>ON</u>	Lock indoor unit Qty.	
BM1_2	The unit startup condition selection	<p>Power on, no matter this dip switch is on "ON" or "OFF" position (default is OFF) don't change the dip switch position, the unit will start after 2 hours preheat or within 2 hours when oil temp. meets the following condition:</p> <ul style="list-style-type: none"> · $CT \leq 25^{\circ}C$ & $Toil \geq CT + 20^{\circ}C$ · $25^{\circ}C < CT \leq 30^{\circ}C$ & $Toil \geq 45^{\circ}C$ continuous for 5 minutes · $CT > 30^{\circ}C$ & $Toil \geq 0.66CT + 25^{\circ}C$ continuous for 5 minutes <p>If you want to reduce the startup condition, you can do the following operation: after power on need one action to change this dip switch to "ON" position (If the dip switch is on "OFF" position, after power on change the "OFF" to "ON"; If the dip switch is on "ON" position, change the "ON" to "OFF" then to "ON") The unit will start after 2 hours preheat or within 2 hours when oil temp. meets the following condition:</p> <ul style="list-style-type: none"> · $CT \leq 45^{\circ}C$ & $Toil \geq 0.923CT + 13.5$ · $CT > 45^{\circ}C$ & $Toil \geq 55^{\circ}C$ <p>CT: saturation temperature is corresponding to the high pressure</p>		
BM1_3	Compressor brand	OFF	Default (MHI compressor)	
BM1_4 BM1_5	Piping length selection (Single way total pipe length)	[4]	[5]	Piping length selection
		OFF	OFF	Medium piping length: $100m < L \leq 200m$ (default)
		OFF	<u>ON</u>	Long piping length: $L > 200m$
		<u>ON</u>	OFF	Short piping length: $L \leq 100m$
BM1_6 BM1_7	Defrosting judge condition	<u>ON</u>	<u>ON</u>	Medium piping length: $100m < L \leq 200m$
		[6]	[7]	Defrosting judge condition
		OFF	OFF	Default setting (Normal installation condition)
		OFF	<u>ON</u>	Low humidification in winter condition
BM1_8	Quiet running function	<u>ON</u>	OFF	High humidification in winter condition (when outdoor unit defrosting is not clear, can set the dip switch on this position)
		OFF	Quiet running function is unavailable (default)	
		<u>ON</u>	Quiet running function is available	

Note:

- The number of indoor units must be locked by the BM1_1 (OFF to ON), otherwise the outdoor unit cannot be started.
- The outdoor unit cannot be started if the locked indoor unit Qty. is not same as Qty. of real indoor units.

BM2 Introduction

BM2	Definition	Introduction		
BM2_1	Cooling only or heat pump selection	OFF	Heat pump (default)	
		<u>ON</u>	Cooling only	
BM2_2 BM2_3	Outdoor capacity selection	[2]	[3]	Outdoor capacity selection
		OFF	OFF	8HP (AWAU-YCVFD220-H13)
		<u>ON</u>	OFF	10HP (AWAU-YCVFD280-H13)
		<u>ON</u>	<u>ON</u>	12HP (AWAU-YCVFD335-H13)
BM2_4	Heat reservation module selection	OFF	Default (no heat reservation module) note: forbid changing	
BM2_5	Indoor and outdoor high drop selection	OFF	No high drop (default)	
		<u>ON</u>	High drop	
BM2_6	Communication protocol selection	OFF	New communication protocol (default)	
		<u>ON</u>	Old communication protocol	
BM2_7 BM2_8	Start mode selection	[7]	[8]	Start mode selection
		OFF	OFF	First open priority
		OFF	<u>ON</u>	After open priority
		<u>ON</u>	OFF	Cooling priority, any one indoor unit runs in cooling mode, the outdoor unit will run in cooling mode, the indoor units running in heating mode will stop.
		<u>ON</u>	<u>ON</u>	Heating priority, any one indoor unit runs in heating mode, the outdoor unit will run in heating mode, the indoor units running in cooling mode will stop.

Note: communication protocol between indoor and outdoor units

The new communication protocol is faster than the old communication and its control content is more than the old one.

The indoor PCB 151800113, 151800161, 0151800161B, 0151800161C, 0151800227, 0151800227A, 0151800244, 0151800244B, 0151800244BA, 0151800086A, 0010451751AF, 0151800141A, 0010451751AE and 151800141 are new communication protocol.

The indoor PCB 151800086 and 0010451181A are old communication protocol.

Old communication protocol indoor PCB can't connect with new communication protocol outdoor, so if this outdoor unit connect with old communication protocol indoor, need set the dip switch BM2-6 to ON position.

12. Digital Tube Display

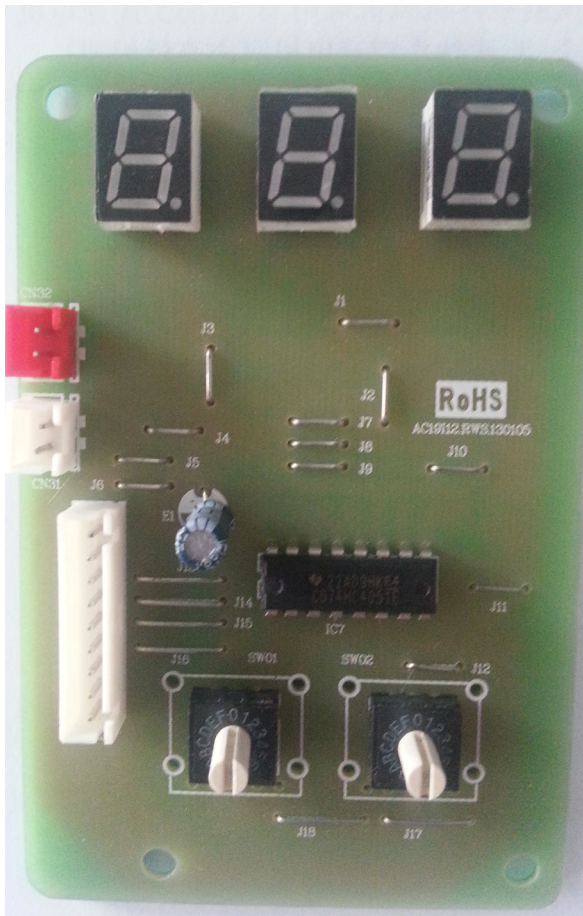

Main function instruction:

By setting the rotary switch, the digital tube will display the outdoor and indoor unit parameters, the data is inform of decimal integer. During the process of installation, adjution and maintenance, the whole system's operating parameters can be tested conveniently which can help to check and solve problems quickly and correctly.

SW01	SW02	Digital tube display
0	0	Display outdoor failure code
	1	Display operation mode
	4	Target frequency of inverter compressor
	5	Current frequency of inverter compressor
	6	Indoor quantity
	7	Running indoor quantity
1	0	Td discharging temperature
	1	Ta ambient temperature
	2	Ts suction temperature
	3	Te defrosting temperature 1
	4	Toil oil temperature
	5	Pd pressure
	6	Ps pressure
	7	Outdoor PMV valve open range
	A	Tfin temperature
	B	Compressor current
	C	Te defrosting temperature 2
E	Forced cooling (Press start for 5sec, all the indoor units are in cooling state, and press stop for 5sec to stop cooling) display "CCC", otherwise "---"	
F	Forced heating (Press start for 5sec, all the indoor units are in heating state, and press stop for 5sec to stop heating) display "HHH", otherwise "---"	
4	0-F	Display indoor failure code
5	0-F	Indoor capacity
7	0-F	Indoor PMV valve open range
9	0-F	Indoor Ta ambient temperature
A	0-F	Indoor TC1 gas temperature
B	0-F	Indoor TC2 liquid temperature
C	0-F	Indoor units: fan speed of indoor units(0-OFF, 1-Low, 2-med, 3-high)
E	0-F	Forced cooling (press "start" for 5sec for cooling operation of indoor units and press "stop" for 5sec to quit)display "CCC", otherwise "---"
F	0-F	Forced heating (press "start" for 5sec for heating operation of indoor units and press "stop" for 5sec to quit)display "HHH", otherwise "---"

13. Failure Code

Digital tube indication on master unit	Indication on wired controller (hex)	Failure code definition	Failure description	Remarks
20	14	Defrosting temp. sensor TE1 failure	AD value is below 11 (open circuit) or over 1012 (short circuit) for 60seconds, in cooling mode, if the sensor is abnormal, the unit does not deal with it, besides, in defrosting and within 3 minutes after defrosting, no alarm.	Resumable
20	14	Defrosting temp. sensor TE2 failure		
21	15	Ambient temp. sensor Ta failure	AD value is below 11 (open circuit) or over 1012 (short circuit) for 60seconds, in defrosting and within 3 minutes after defrosting, no alarm.	Resumable
22	16	Suction temp. sensor Ts failure	AD value is below 11 (open circuit) or over 1012 (short circuit) for 60seconds, in defrosting and within 3 minutes after defrosting, no alarm.	Resumable
23	17	Discharging temp. sensor Td failure	After compressor is running for 5 minutes, AD value is below 11 (open circuit) or over 1012 (short circuit) for 60seconds, in course of startup, defrosting and within 3 minutes after defrosting, no alarm.	Resumable
24	18	Oil temp. sensor Toil failure	AD value is below 11 (open circuit) or over 1012 (short circuit) for 60seconds, if $Ta \leq -10^{\circ}$ or $ET \leq -10^{\circ}$, within 5 minutes, no alarm.	Resumable
26	1A	Indoor communication failure	For continuous 200 cycles, can not find connected indoors.	Resumable
26-1	1A		For continuous 300seconds, the searched indoor quantity is less than the set quantity.	
26-2	1A		For continuous 300seconds, the searched indoor quantity is more than the set quantity.	
27	1B	Oil temp.too high protection (Toil)	Toil $\geq 110^{\circ}$ at interval of 25msec for twice continuously, and over the set value, then stop and alarm; 3 minutes later, resume automatically. If it occurs 3 times in an hour, confirm the failure.	Once confirmation, un-resumable
28	1C	High pressure sensor Pd failure	AD value is below 11 (open circuit) or over 1012 (short circuit) for 30seconds, in defrosting and within 3 minutes after defrosting, no alarm.	Resumable

LD indication on master unit	Indication on wired controller (hex)	Failure code definition	Failure description	Remarks
29	1D	Low pressure sensor Ps failure	AD value is below 11 (open circuit) or over 1012 (short circuit) for 30seconds, in defrosting and within 3 minutes after defrosting, no alarm.	Resumable
30	1E	High pressure switch HPSi failure	If disconnect for 50ms continuously, alarm. If alarm 3 times in an hour, confirm the failure.	Once confirmation, un-resumable
33	21	EEPROM failure	EEPROM failure.	Once confirmation, un-resumable
34	22	Discharging temp. too high protection (Td)	Td \geq 115degree at interval of 25msec for twice continuously, and over the set value, then stop and alarm; 3 minutes later, resume automatically. If it occurs 3 times in an hour, confirm the failure.	Once confirmation, un-resumable
35	23	4-way valve reversing failure	After 4-way valve is electrified for 3 minutes, if the below conditions can be met for continuous 10 seconds, that is conversing successfully: 1. this outdoor compressor is running normally 2. Pd-Ps \geq 0.6MPa, Otherwise, the system alarms reversing failure.	Once confirmation, un-resumable
36	24	Oil temp. too low protection (Toil)	In normal operation, if Td<CT+6°Cfor continuous 5 minutes, the unit stops and alarms. 2 minutes and 50 seconds later, resume automatically. If it occurs 3 times in an hour, confirm the failure.	Once confirmation, un-resumable
39-0	27	Low pressure sensor Ps too low protection	After compressor is running (except for residual operation), if in cooling, Ps<0.05Mpa; in heating, Ps<0.03Mpa; in oil return, Ps<0.03Mpa for continuous 5 minutes, alarm and stop. 2 minutes and 50 seconds later, resume automatically, if it occurs 3 times in an hour, confirm the failure.	Once confirmation, un-resumable
39-1	27	Compression ratio too high protection	After compressor is running, compression ratio ϵ <8. for continuous 5 minutes stop and alarm. 2 minutes and 50 seconds later, resume automatically, if it occurs 3 times in an hour, confirm the failure.	Once confirmation, un-resumable

LD indication on master unit	Indication on wired controller (hex)	Failure code definition	Failure description	Remarks
39-2	27	Compression ratio too low protection	In normal operation, compression ratio $\varepsilon < 1.8$ for continuous 5 minutes stop and alarm. 2 minutes and 1 seconds later, resume automatically, if it occurs 3 times in an hour, confirm the failure.	Once confirmation, un-resumable
40	28	High pressure sensor Pd too high protection	In normal operation, Pd ≥ 4.15 Mpa for continuous 50ms, alarm and stop. 2 minutes and 50 seconds later, resume automatically, if it occurs 3 times in an hour, confirm the failure.	Once confirmation, un-resumable
43	2B	Discharging temp. sensor Td too low protection	In normal operation, if Td $< CT + 10^{\circ}C$ for continuous 5 minutes, the unit stops and alarms. 2 minutes and 50 seconds later, resume automatically. If it occurs 3 times in an hour, confirm the failure. After fixed frequency compressor alarms, inverter compressor will continue to run. If fixed frequency compressor has been locked for 3 times, the unit will stop and alarm.	Once confirmation, un-resumable
46	2E	Communication with inverter board failure	No communication within 30 seconds continuously.	Resumable
71	47	DC motor blocked	Running at speed below 20rpm for 30s, or at speed of 70% lower than the target for 2 minutes, 2 minutes and 50 seconds later after stop, resume automatically. It occurs 3 times in an hour, confirm the failure.	Once confirmation, un-resumable
75	4B	No pressure drop between high pressure and low one	In 5 minutes after inverter compressor starts up, Pd - Ps ≤ 0.2 MPa. 2 minutes and 50 seconds later after unit stops, resume automatically, if it occurs twice continuously, confirm the failure.	Once confirmation, un-resumable
78	4E	Lack of refrigerant	Compressor running in cooling mode, Ps < 0.2 MPa for 30 minutes; compressor running in heating mode, Tsi - ET > 20 ; LEV will fully open for 60 minutes, the unit will output lack of refrigerant alarm, unit will not stop.	--

LD indication on master unit	Indication on wired controller (hex)	Failure code definition	Failure description	Remarks
110	6E	IPM modular protection (F0)	IPM modular over current, in short circuit, over heat, voltage too low of control circuit.	3 times in an hour, confirm failure; once confirmation, un-resumable
111	6F	Compressor out of control	In the course of compressor startup or running, the unit can not detect the rotor position, or not connecting compressor.	
112	70	Radiator of module temp.too high	Radiator temp. too high.	
113	71	Module overload	Output current of module is too high.	
114	72	Voltage too low of DC bus line of module	Voltage of power source is too low.	
115	73	Voltage too high of DC bus line of module	Voltage of power source is too high.	
116	74	Communication abnormal between module and control PCB	Communication is disconnected.	Resumable
117	75	Module over current (software)	Compressor startup fails for 5 times continuously, or compressor is running down till stops caused by over current or over heat.	3 times in an hour, confirm failure; once confirmation, un-resumable
118	76	Compressor startup failure	The sensor used for current detecting of module is abnormal, disconnected or incorrectly connection.	
120	78	Power supply of module abnormal	Power supply of module is broken down instantly.	
121	79	Power supply of inverter board is abnormal	Power supply of inverter board is broken down instantly.	3 times in an hour, confirm failure; once confirmation, un-resumable
122	7A	Radiator temp. sensor of module abnormal	Resistor of temp.sensor abnormal or temp.sensor disconnected.	

When there is no failure, if the starting condition can not be met, digital tube on master unit will display stand-by code:

Code	Standby code description
555.0	When indoor horse power / outdoor horse power is over 130% or lower than 50%, the system is standby.
555.1	When it is in heating mode with ambient temp. over 27°C the system standby
555.3	When it is in cooling mode with ambient temp. over 54°C or lower -10°C, the system is standby.
555.4	Oil temperature is too low, the system is standby. heater in heating compressor up to 2 hours
U**	BM1-1 is OFF, the outdoor is searching indoor unit. U** is the number of indoor. E.g. U16 represents 16 indoor units within system. If the number of indoor units is correct, please set BM1-1 to ON.

Failure code display method

1. Digital tube:

If the failure code is 26-0, the digital tube display [26] first, then display [-0]

If the failure code is 555.0, the digital tube display [555] first, then display [.]0]

The failure display time is 1s and display interval time is 2s

2. LED lamp:

LED1 stands for ten digits and LED3 stands for single digits

If the failure code is 26-0, first the LED1 flashes 2 times, then LED 3 flashes 6 times, cycle display like this

If the failure code is 111-1, first the LED1 flashes 11 times, then LED 3 flashes 1 time, then LED 1 is on

and LED3 flashes 1 time at the same time, cycle display like this

If the failure code is 555.0, LED1 and LED3 are on

If the failure code is 555.4, LED1 and LED3 flash 4 times at the same time, cycle display like this

LED lamp flashing frequency is 2hz, display interval time is 2s

14. Troubleshooting

[20~24] Temperature sensor failure

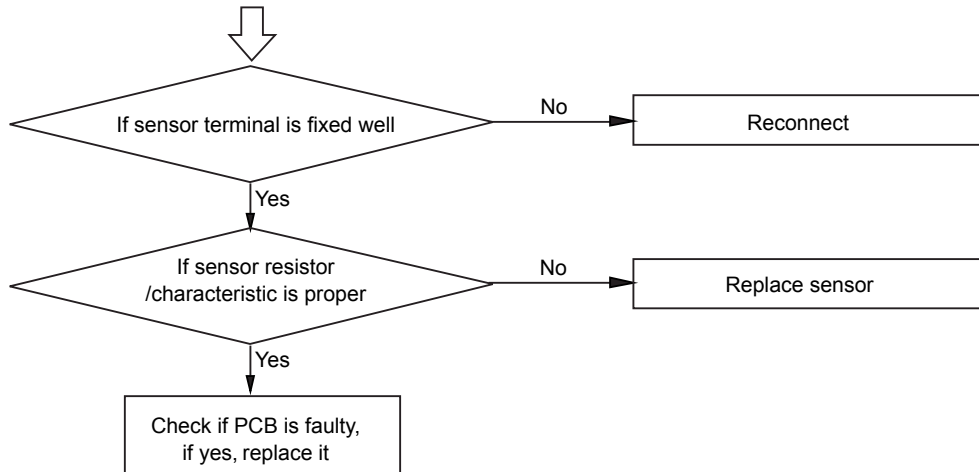

[27] Protection of oil temperature too high

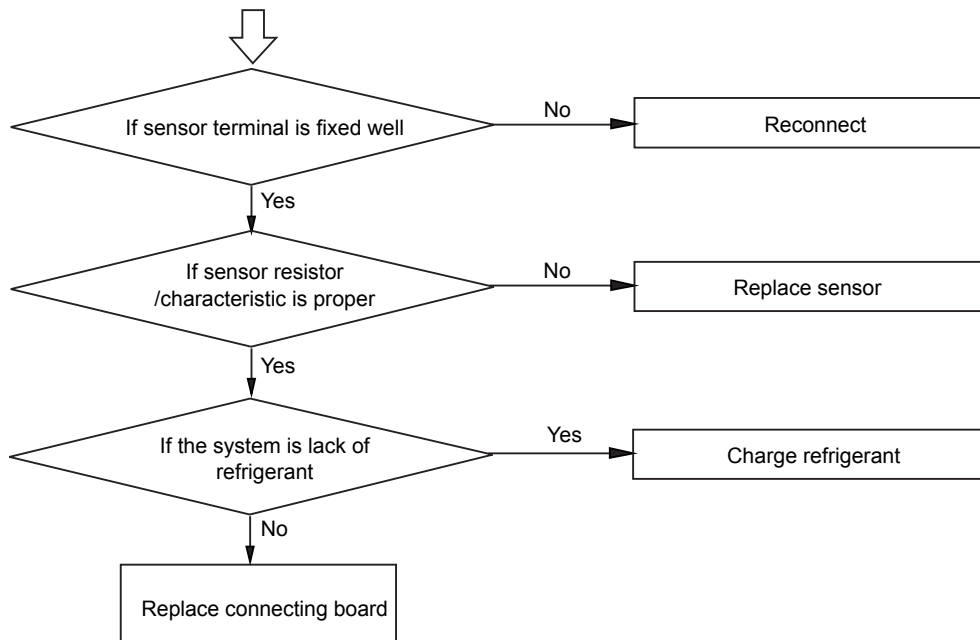

[26-0, 26-1, 26-2] Communication circuit between indoor and outdoor

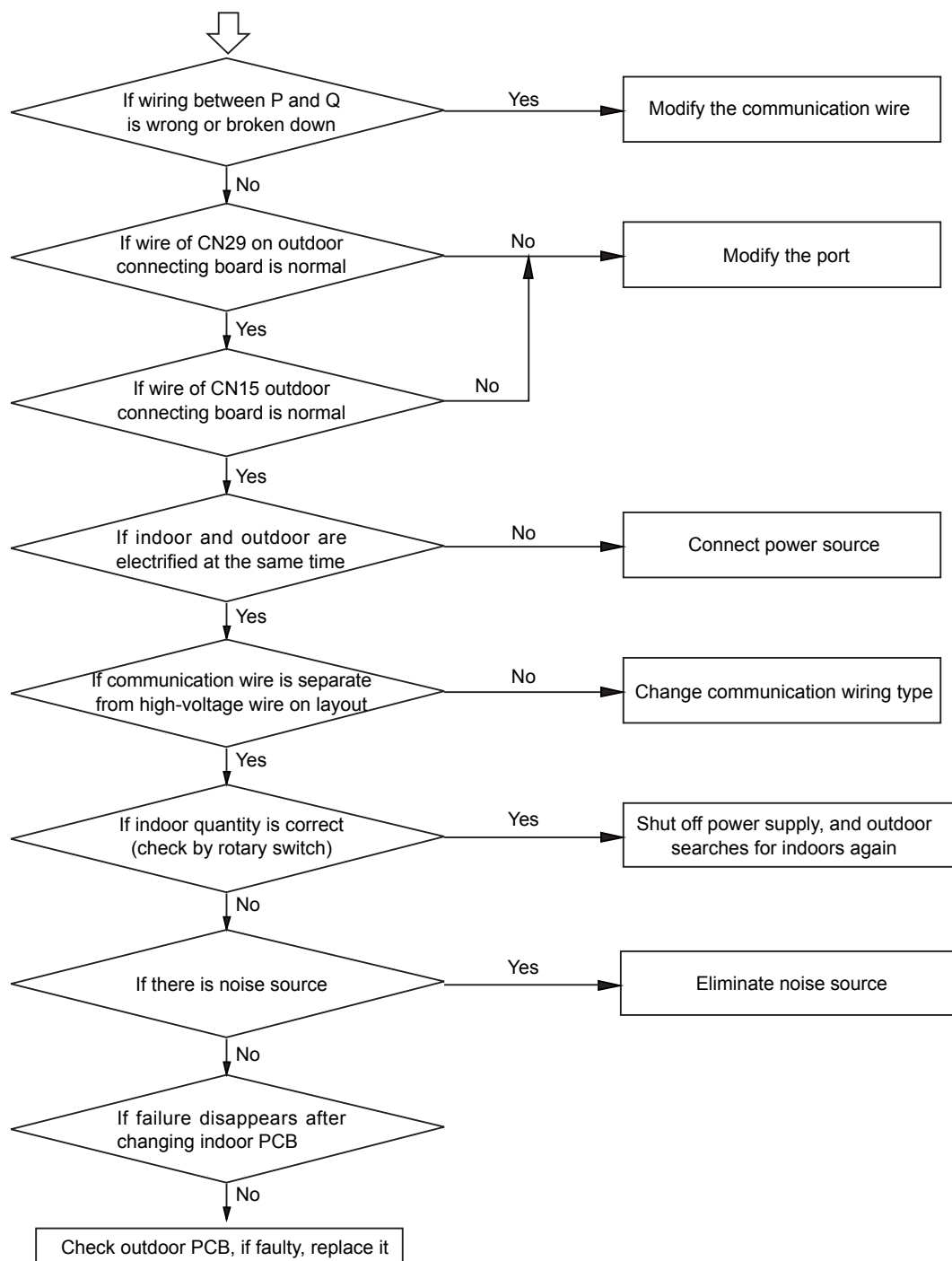

[28, 29] High/low pressure sensor failure

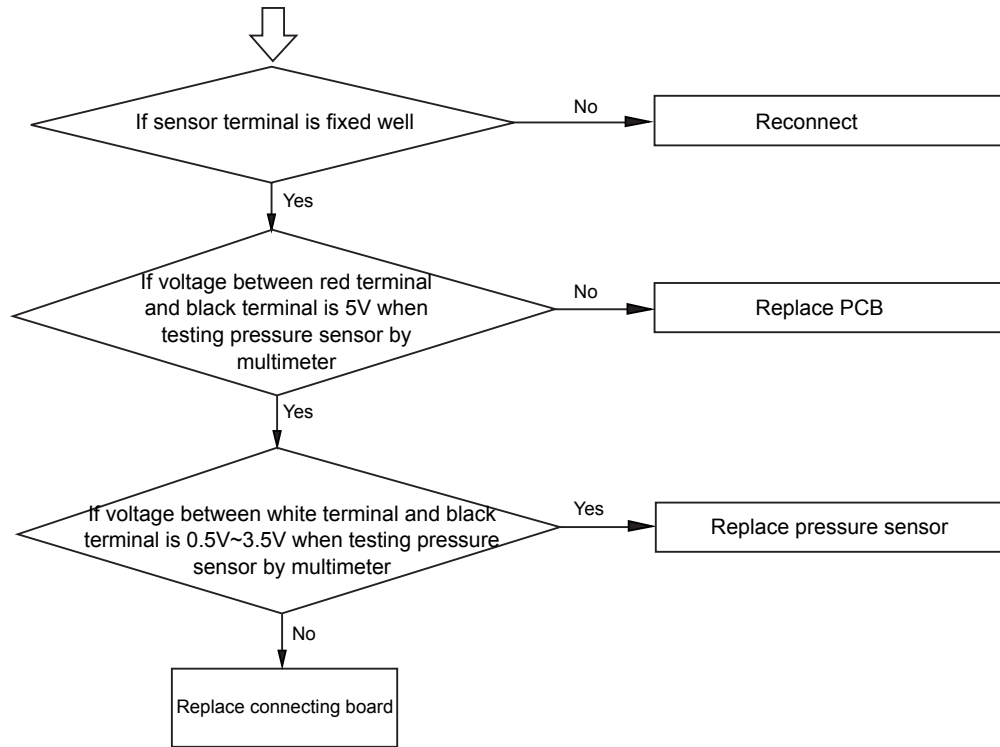

[33] Outdoor EEPROM failure

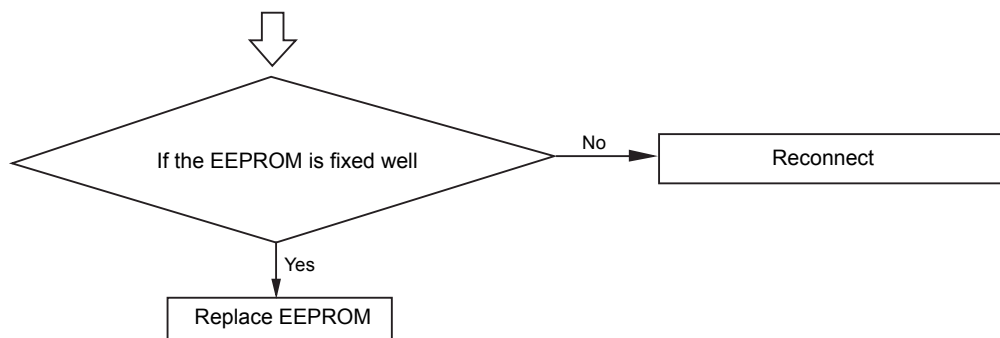

[30] High pressure switch shutoff failure

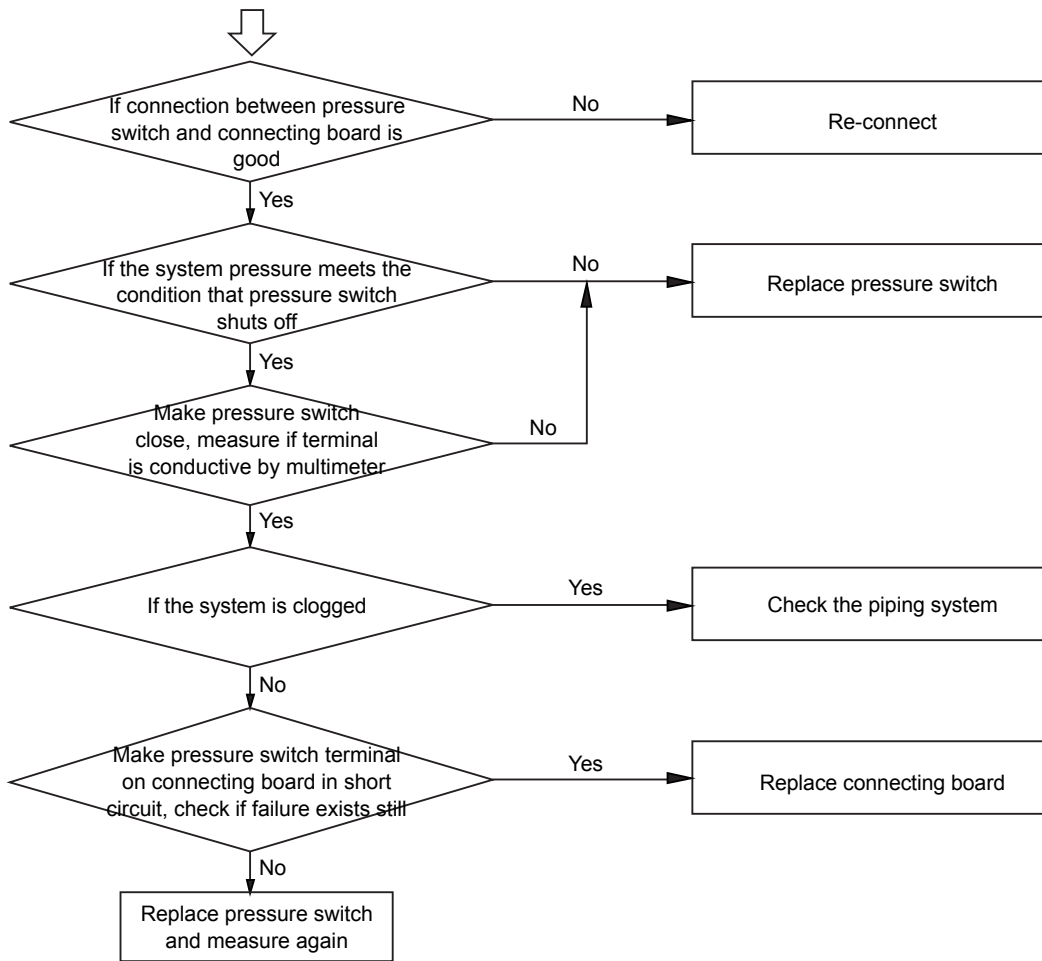

[34] Protection of discharging temp.too high

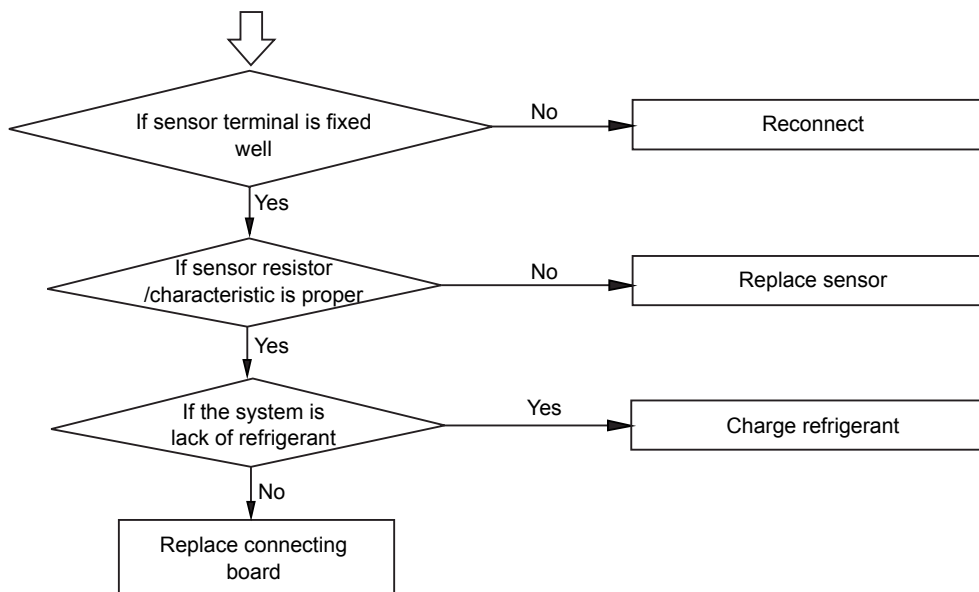

[35] 4-way valve reversing failure

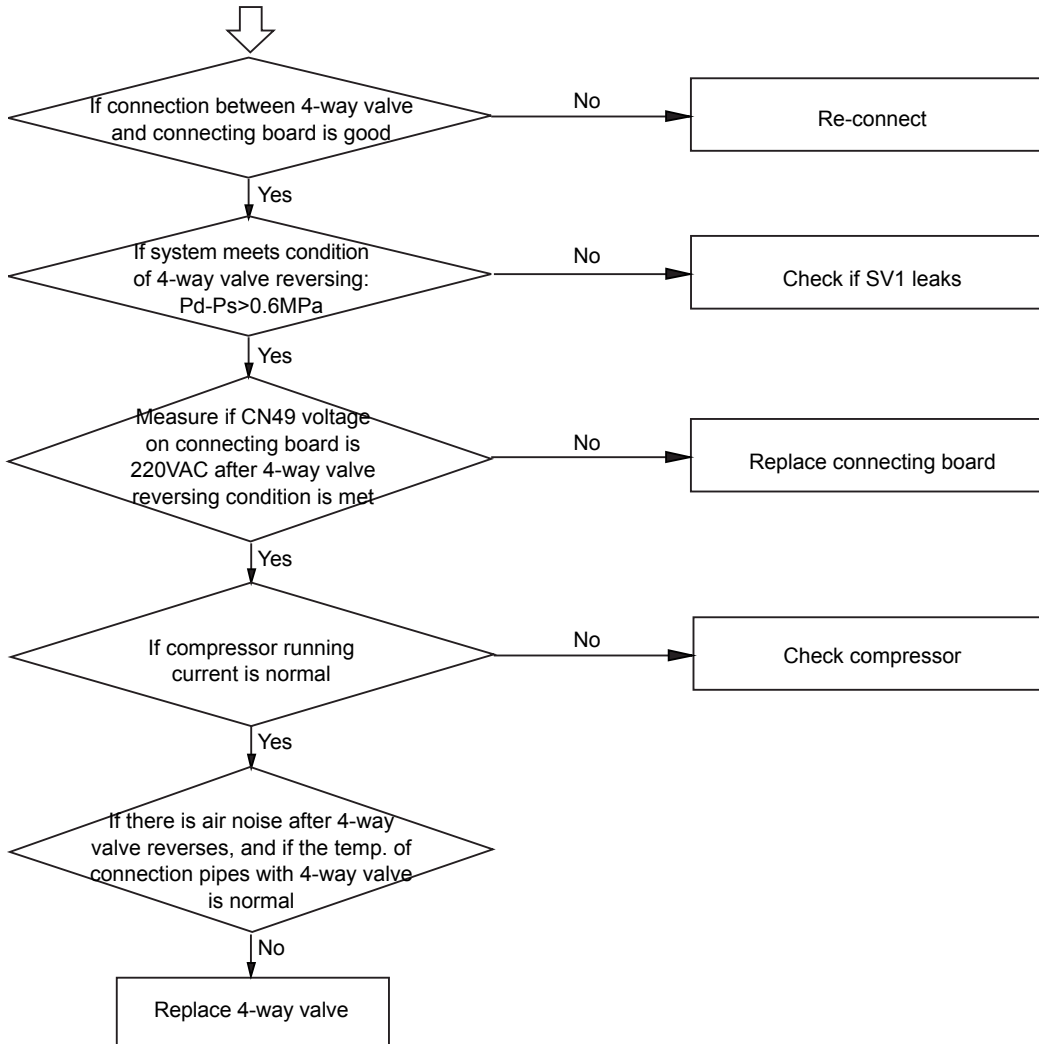

[36] Protection of oil temperature too low

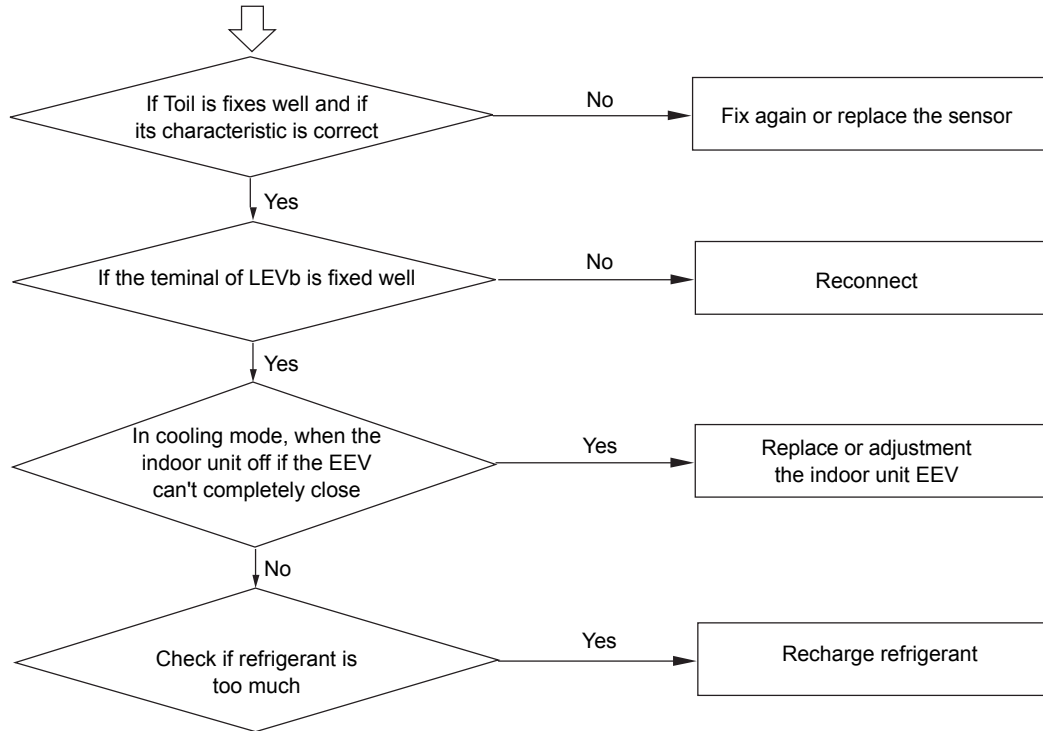

[39-0, 39-1] Low pressure too low and compression ratio too high

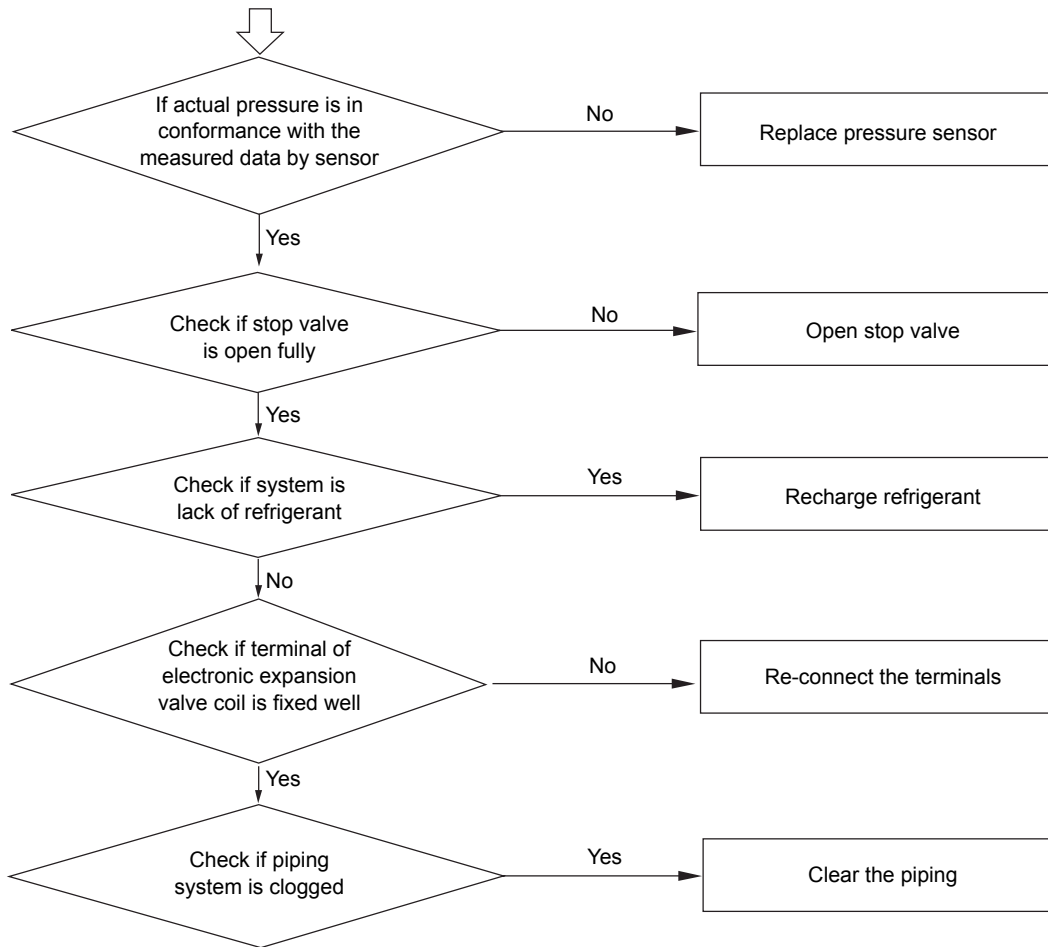

[39-2] Compression ratio too low

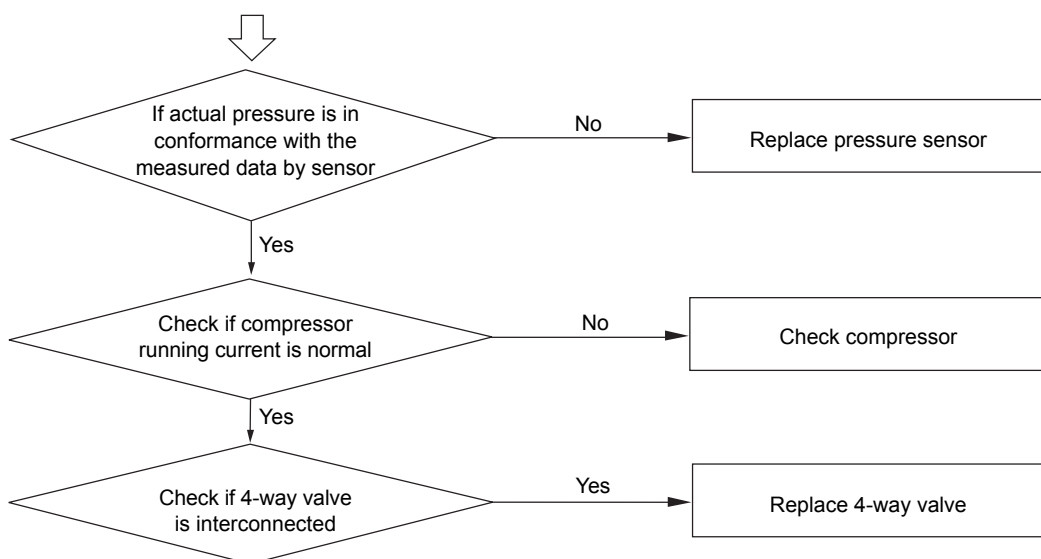

[40] High pressure protection

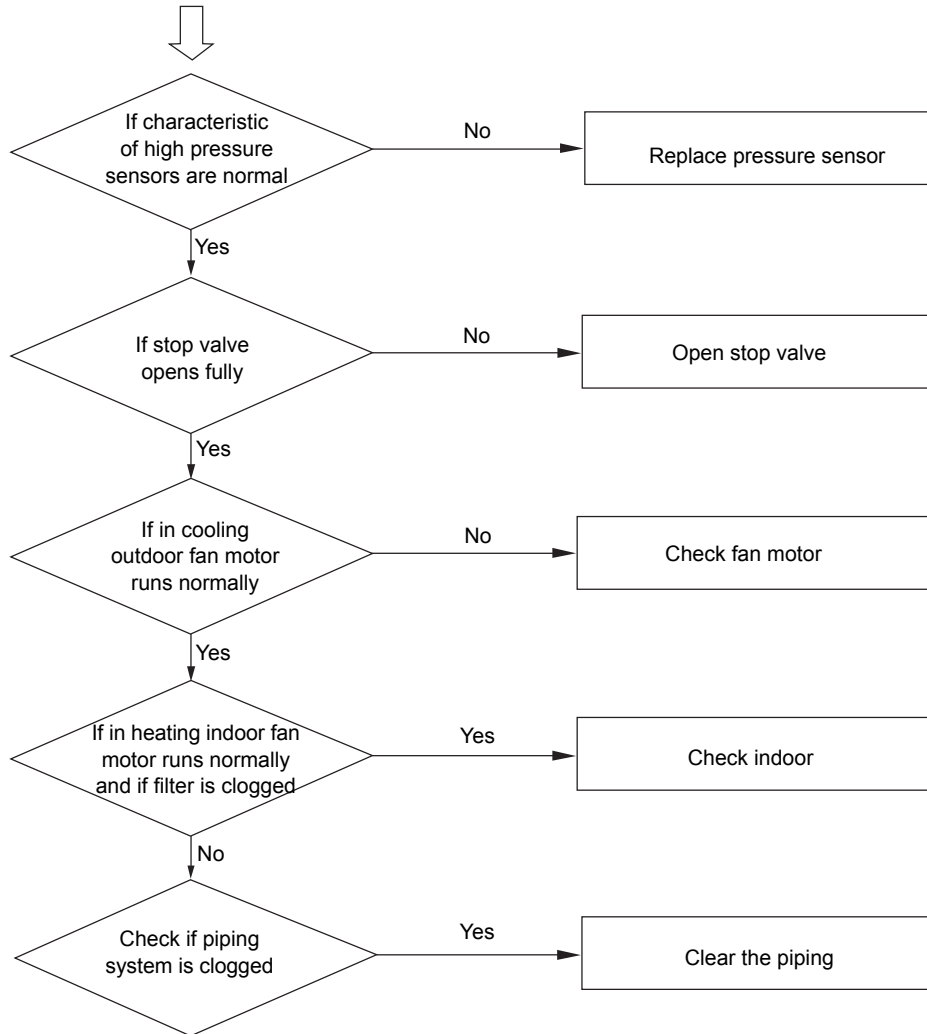

[43] Discharging temp.sensor Td too low protection

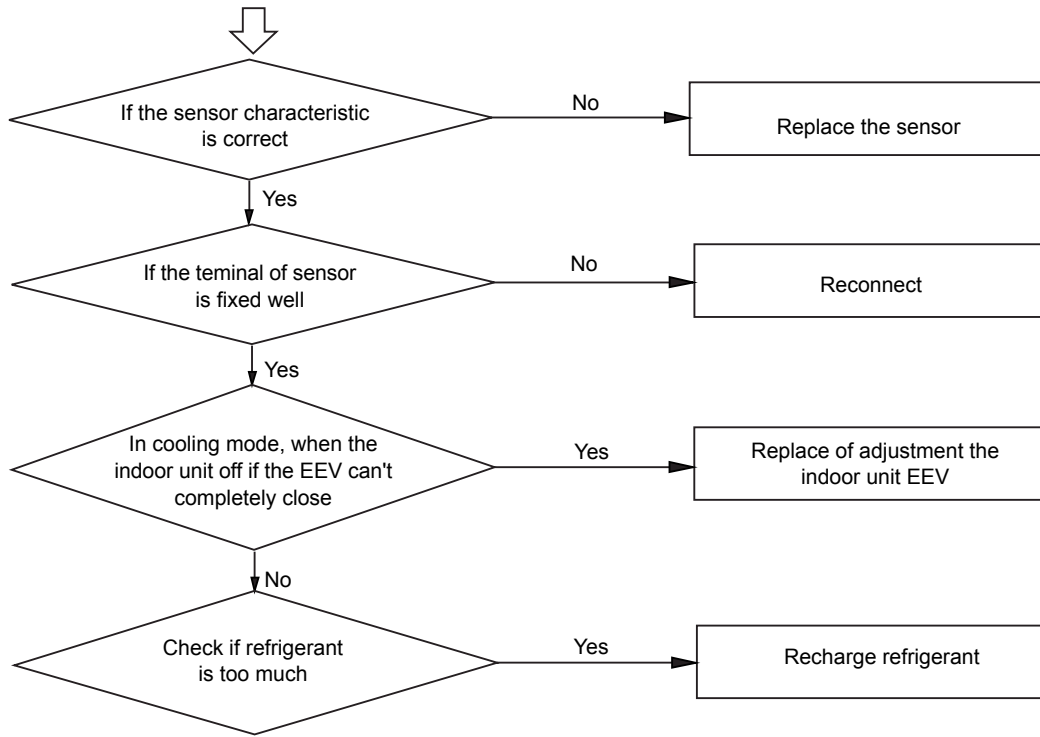

[46] Communication with inverter module failure

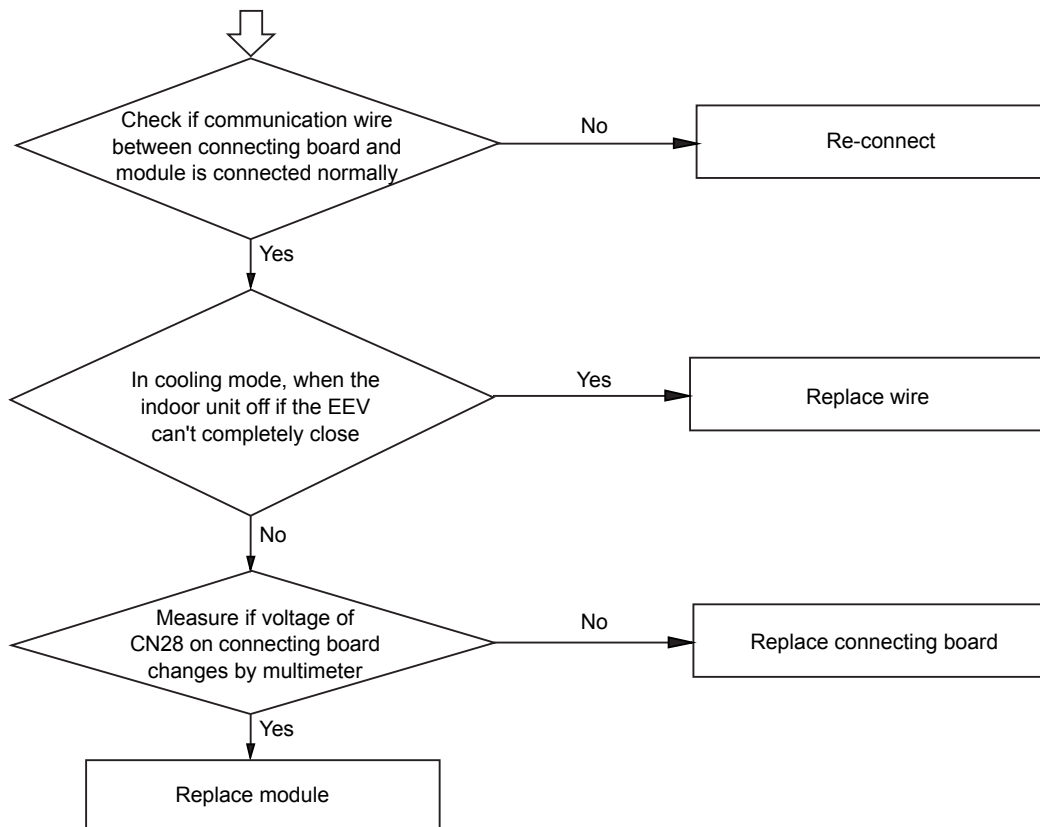

[71] DC motor blocked

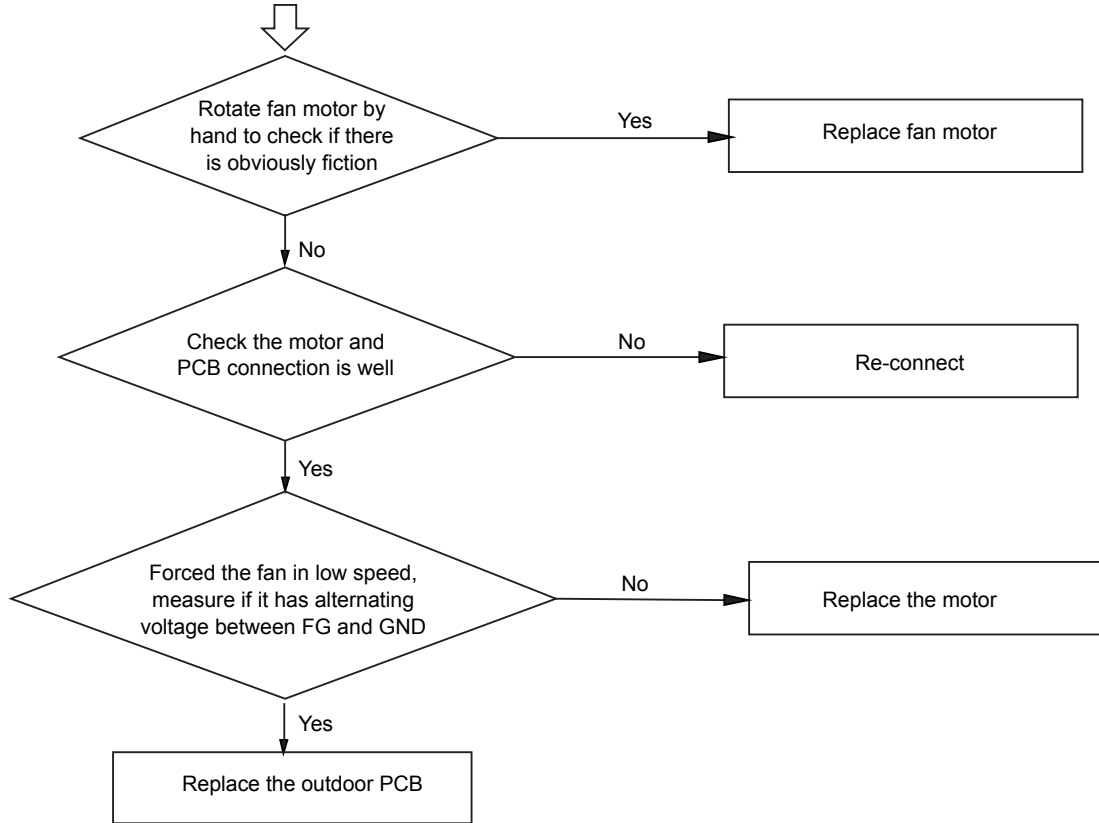

[75] No pressure drop between high pressure and low one

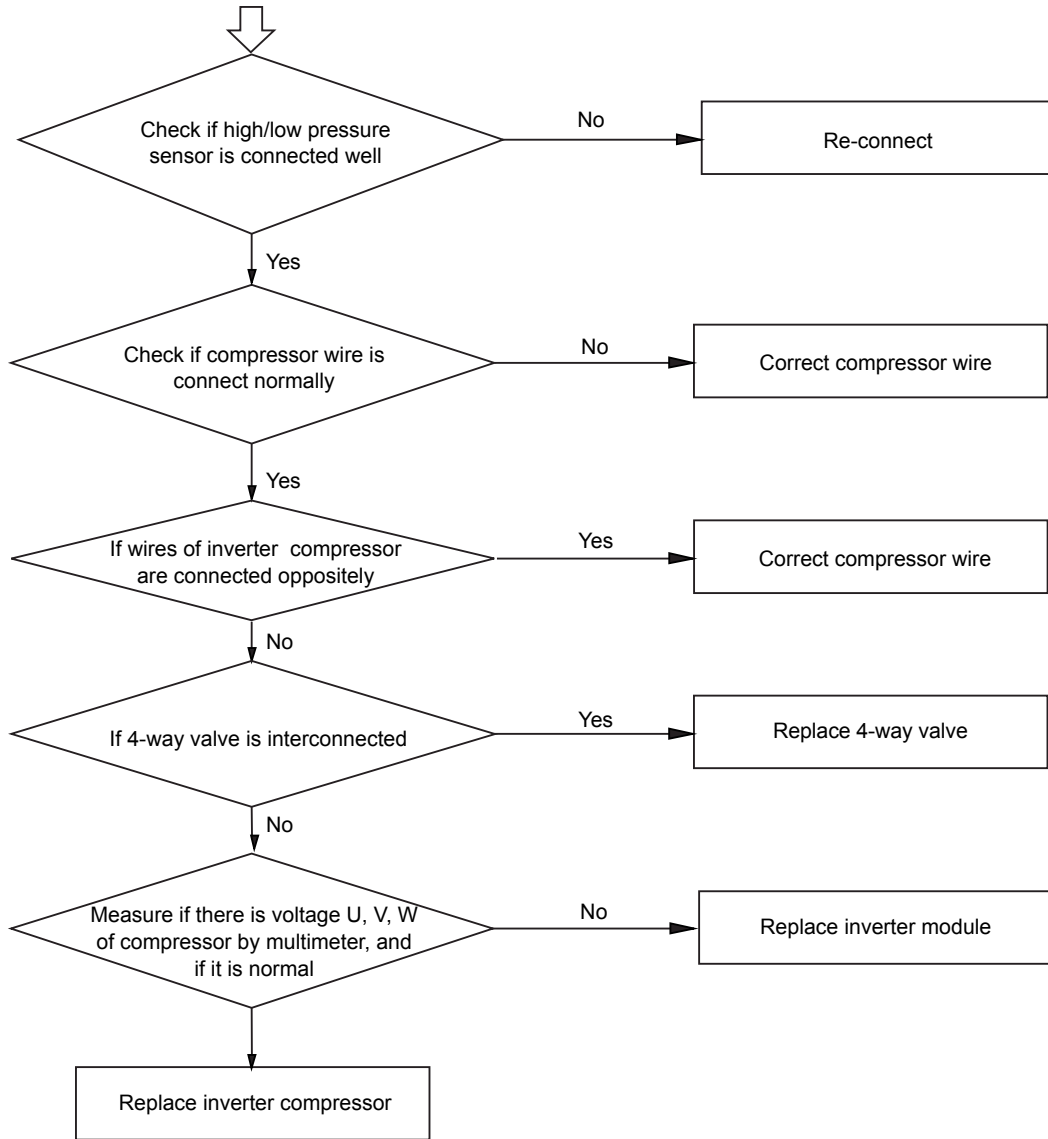

[110] Power module overcurrent

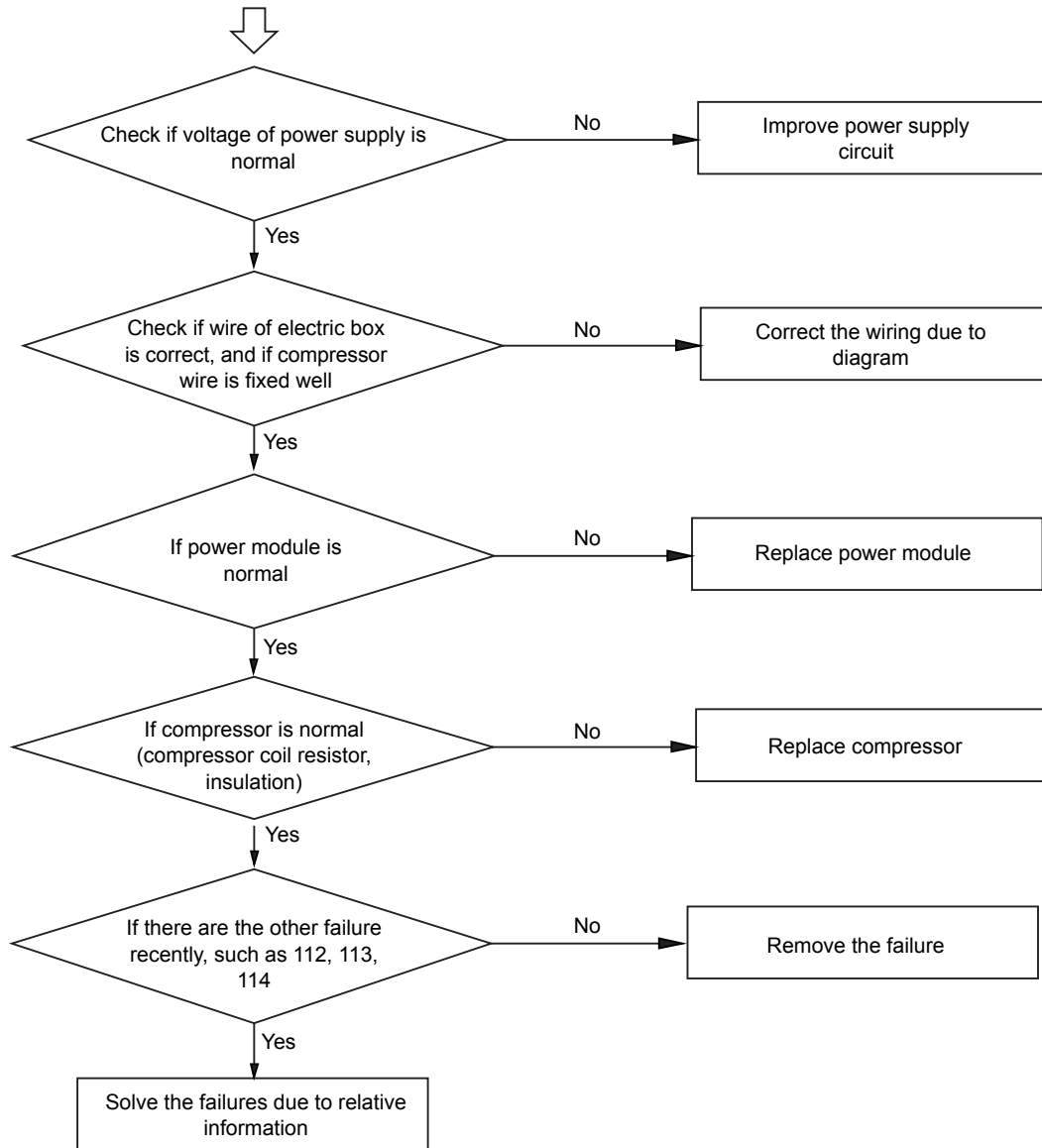

[111] Compressor out of control

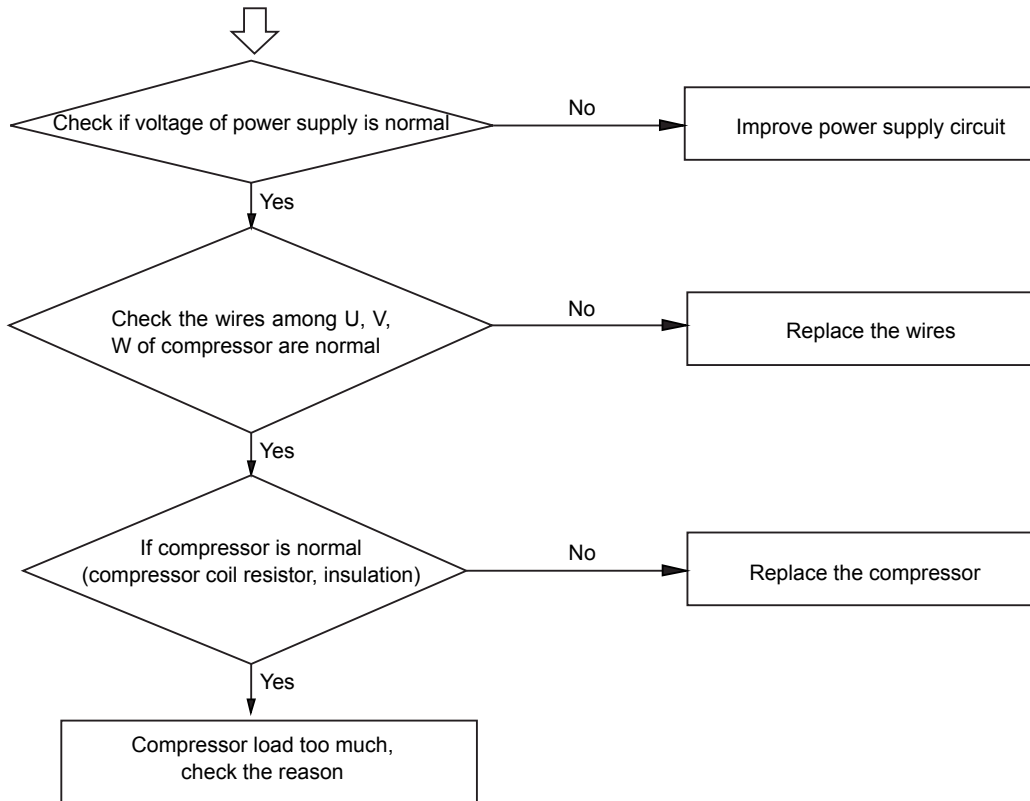

[112] Radiator of transducer temp. too high

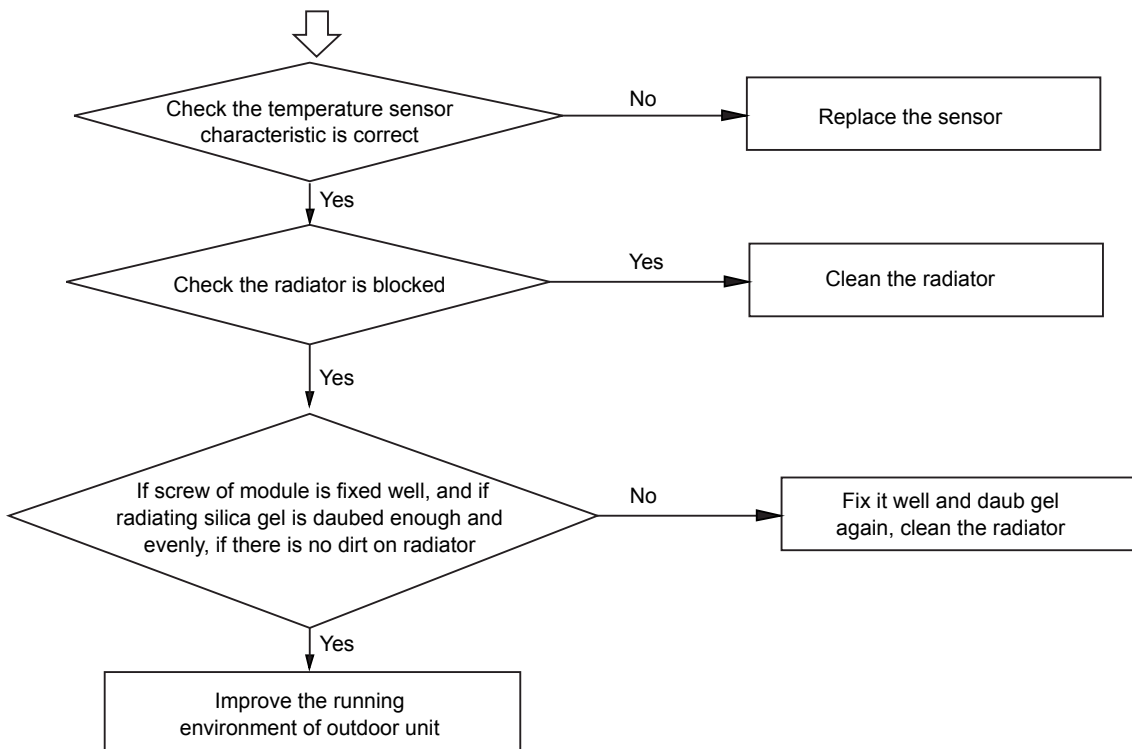

[113] Protection of overload

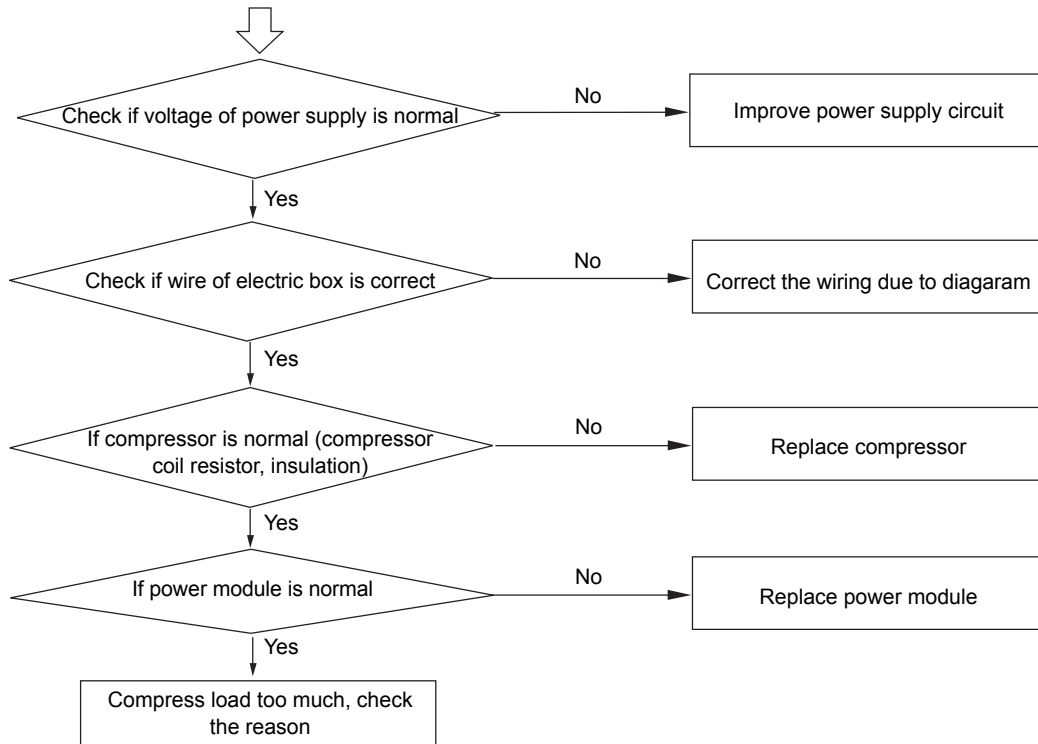

[114] Voltage too low of DC bus line of transducer

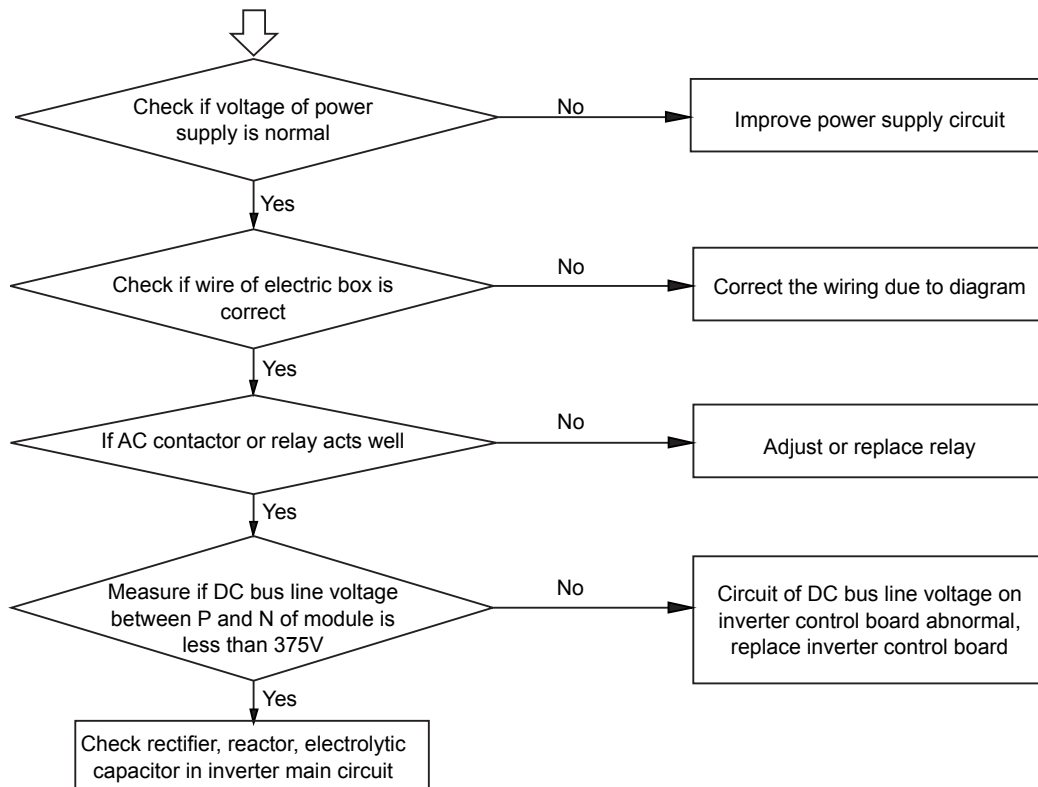

[115] Voltage too high of DC bus line of transducer

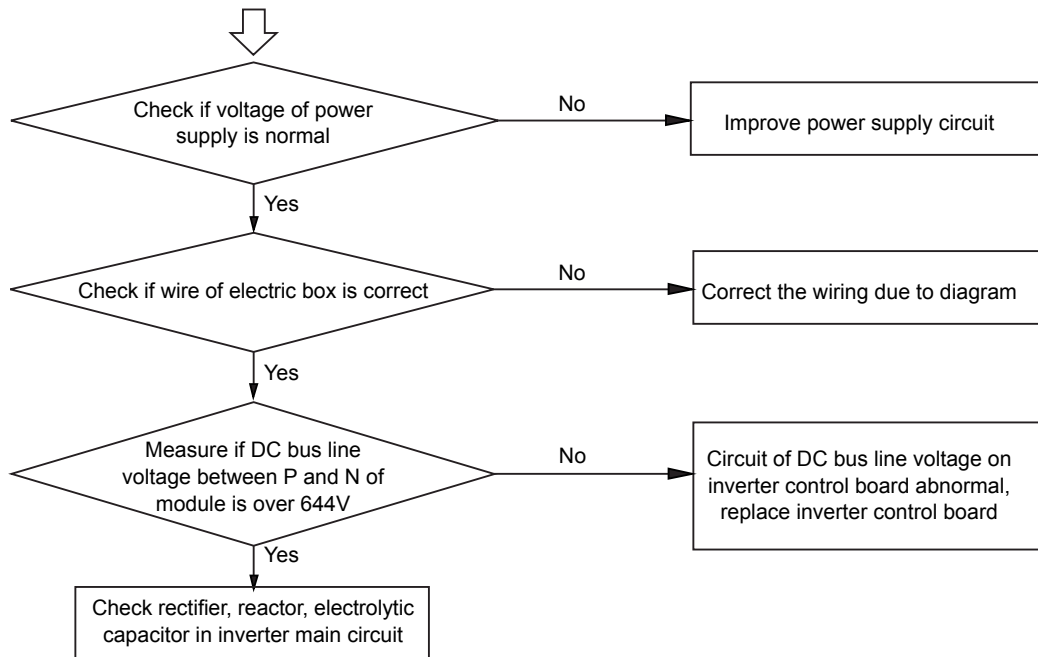

[116] Communication abnormal between transducer (inverter module board) and control PCB

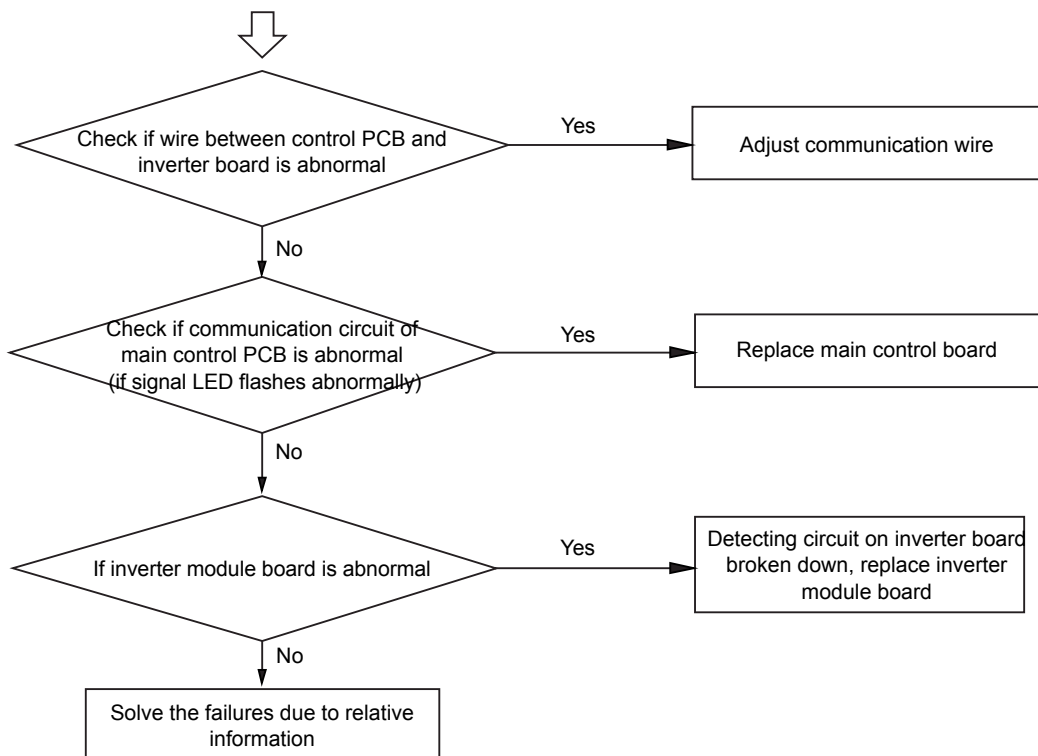

[117] Transducer over current (software protection)

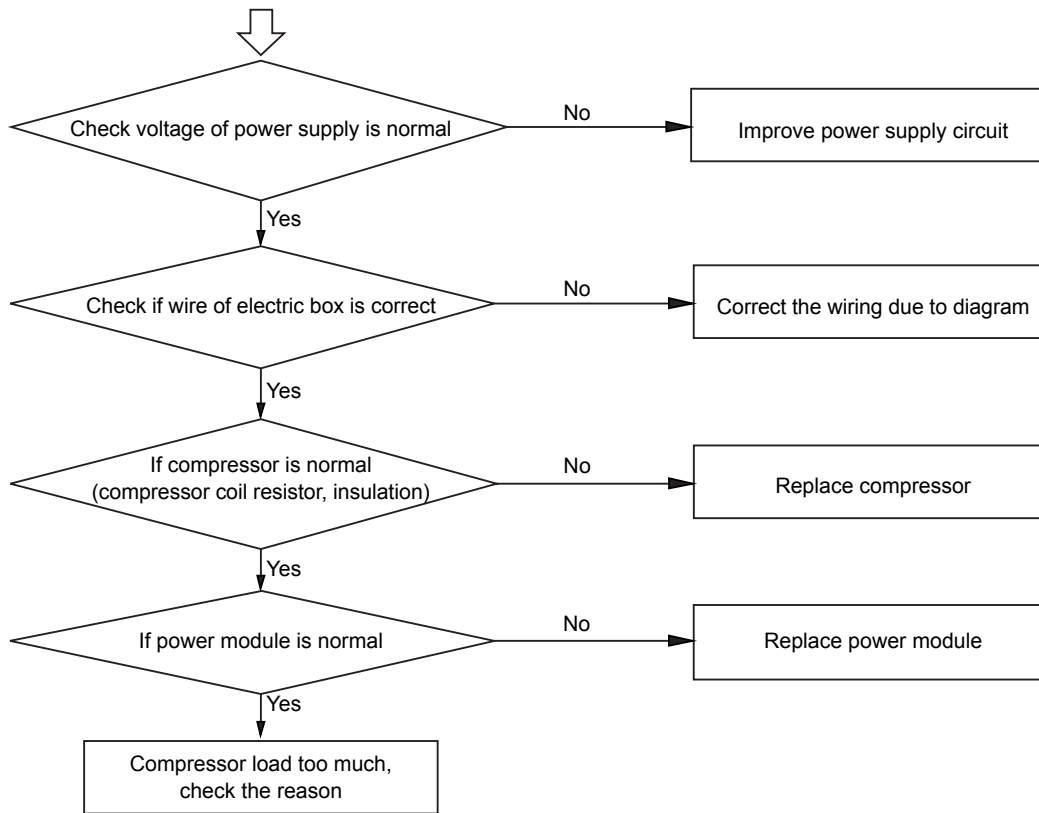

[118] Compressor startup failure

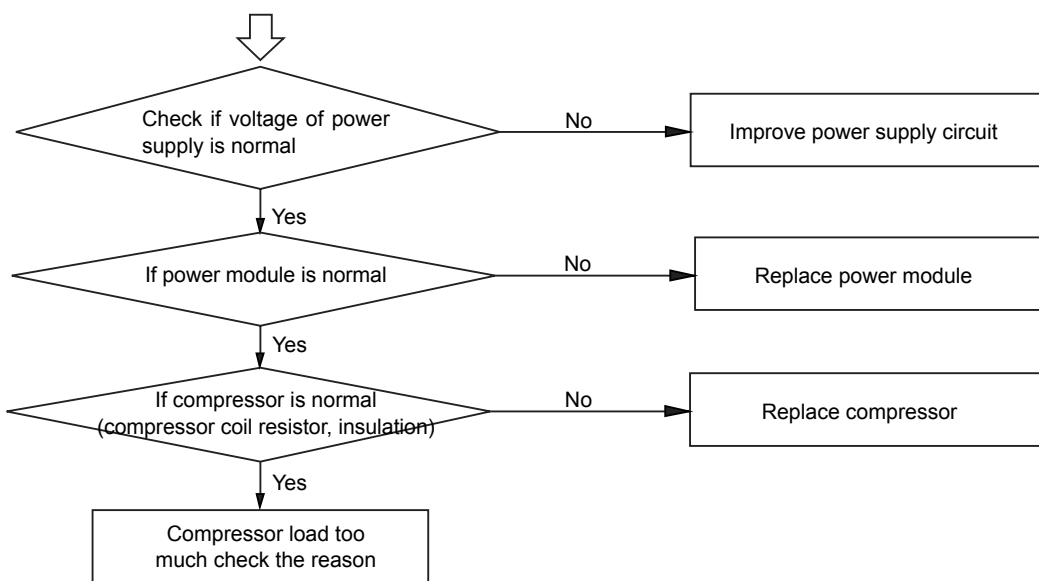

[120] Power supply of transducer abnormal

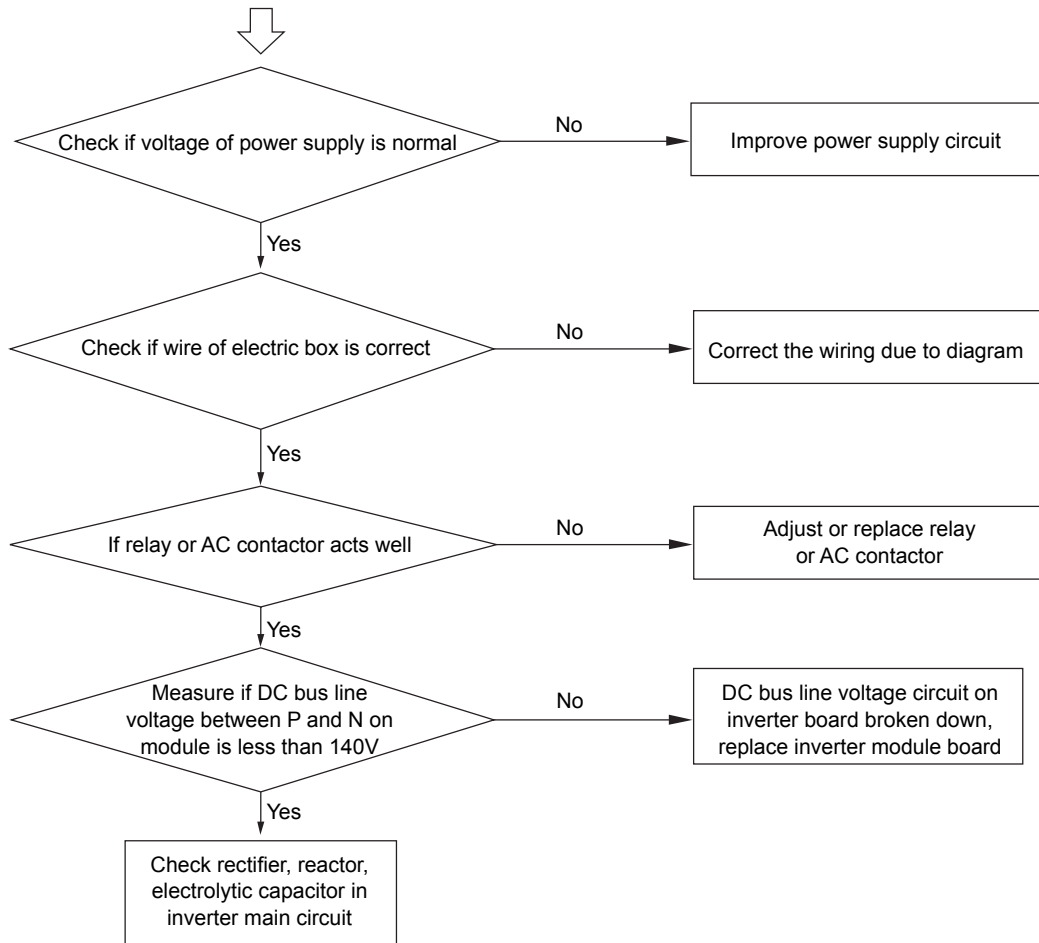

[121] Power supply of inverter board is abnormal

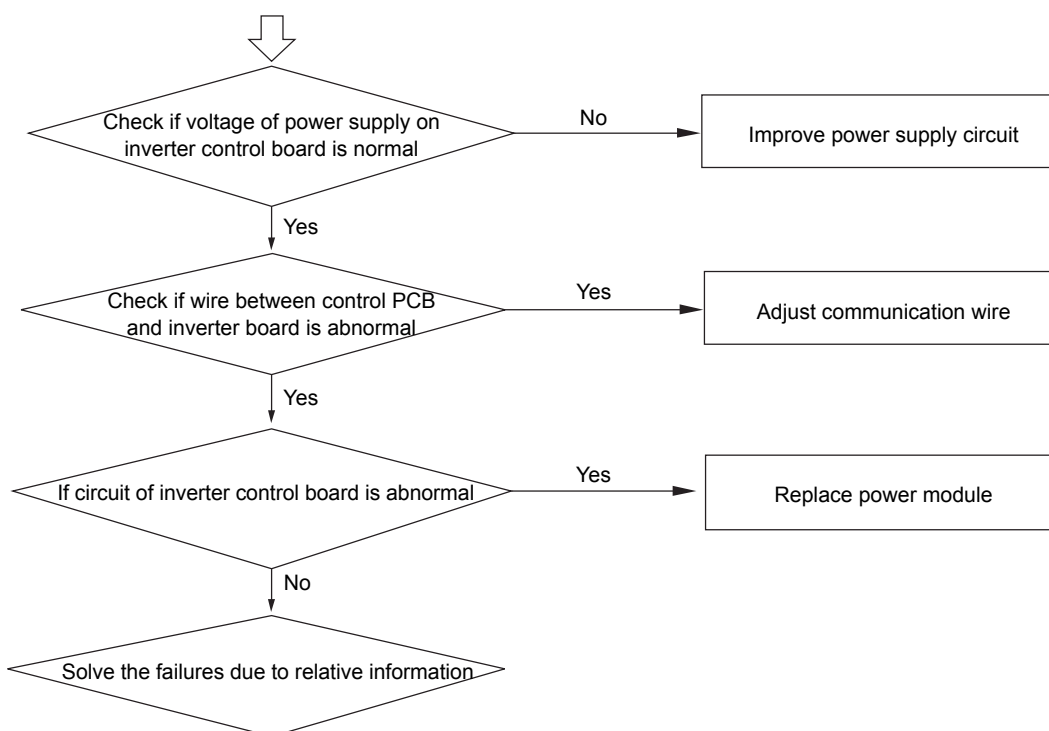

[122] Radiator temp.sensor of transducer abnormal

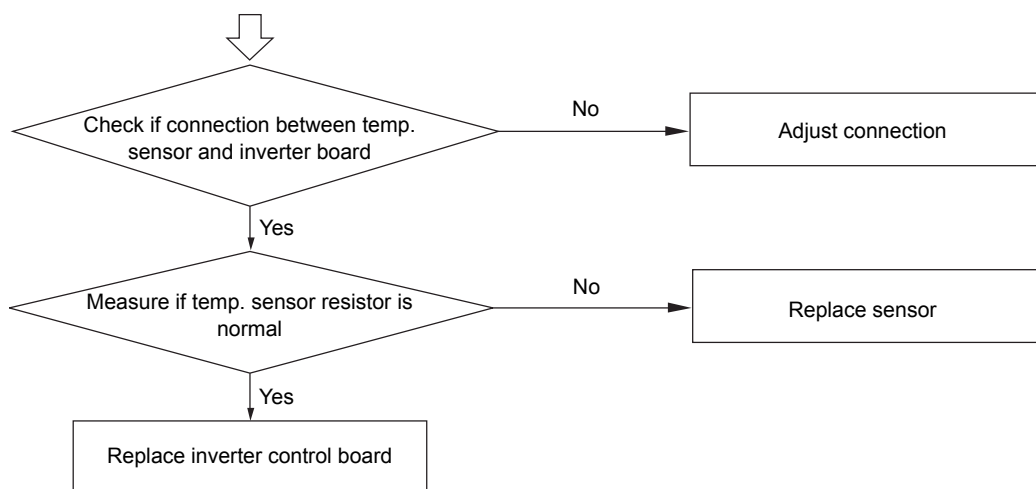

APPENDIX

1. Sensor characteristic

Temp. sensor characteristic

No.	Sensor type	Characteristic
1	Indoor coil/outdoor Ta Te1, Te2 , Ts	R (25°C)=10kΩ B (25°C/50°C)=3700K
2	Indoor ambient temp.sensor	R (25°C)=23 kΩ B (25°C/50°C)=4200K
3	Outdoor Td , Toil	R (80°C)=50 kΩ B (25°C/80°C)=4450K
4	Outdoor Tfin	R (50°C)=17kΩ B (25°C/50°C)=4170K

2. Saturated R410A thermodynamic characteristic

R50=17K \pm 2% B25/50=4170K \pm 3%							
Temp (°C)	Rmin	R (t) Normal	Rmax	Temp (°C)	Rmin	R (t) Normal	Rmax
0	164.73	176.38	187.00	53.00	14.73	15.07	15.41
1	156.21	167.10	177.02	54.00	14.14	14.48	14.82
2	148.19	158.36	167.64	55.00	13.58	13.93	14.26
3	140.63	150.13	158.81	56.00	13.05	13.39	13.72
4	133.50	142.38	150.49	57.00	12.53	12.88	13.20
5	126.77	135.07	142.66	58.00	12.04	12.38	12.71
6	120.42	128.18	135.28	59.00	11.58	11.91	12.24
7	114.43	121.68	128.32	60.00	11.13	11.46	11.79
8	108.77	115.55	121.76	61.00	10.70	11.03	11.35
9	103.42	109.76	115.58	62.00	10.29	10.62	10.94
10	98.37	104.30	109.74	63.00	9.90	10.23	10.54
11	93.59	99.14	104.23	64.00	9.52	9.85	10.16
12	89.07	94.26	99.02	65.00	9.16	9.49	9.79
13	84.80	89.65	94.11	66.00	8.82	9.14	9.44
14	80.76	85.29	89.47	67.00	8.49	8.81	9.10
15	76.93	81.17	85.08	68.00	8.18	8.49	8.78
16	73.31	77.27	80.93	69.00	7.87	8.18	8.47
17	69.87	73.58	77.01	70.00	7.58	7.89	8.17
18	66.62	70.09	73.30	71.00	7.31	7.61	7.89
19	63.54	66.78	69.78	72.00	7.04	7.33	7.61
20	60.62	63.65	66.46	73.00	6.78	7.08	7.35
21	57.84	60.68	63.31	74.00	6.54	6.83	7.10
22	55.22	57.87	60.33	75.00	6.30	6.59	6.85
23	52.72	55.20	57.50	76.00	6.08	6.36	6.62
24	50.35	52.67	54.82	77.00	5.86	6.14	6.39
25	48.10	50.27	52.28	78.00	5.65	5.93	6.18
26	45.97	47.99	49.87	79.00	5.45	5.72	5.97
27	43.94	45.83	47.59	80.00	5.26	5.53	5.77
28	42.01	43.77	45.42	81.00	5.08	5.34	5.58
29	40.18	41.82	43.37	82.00	4.90	5.16	5.39
30	38.43	39.97	41.41	83.00	4.73	4.98	5.22
31	36.78	38.21	39.56	84.00	4.57	4.82	5.04
32	35.20	36.53	37.79	85.00	4.41	4.66	4.88
33	33.70	34.94	36.12	86.00	4.26	4.50	4.72
34	32.27	33.43	34.53	87.00	4.12	4.35	4.57
35	30.91	31.99	33.01	88.00	3.98	4.21	4.42
36	29.61	30.62	31.57	89.00	3.84	4.07	4.28
37	28.38	29.31	30.21	90.00	3.71	3.94	4.14
38	27.20	28.07	28.90	91.00	3.59	3.81	4.01
39	26.08	26.89	27.66	92.00	3.47	3.69	3.88
40	25.01	25.76	26.48	93.00	3.36	3.57	3.76
41	23.99	24.69	25.36	94.00	3.24	3.45	3.64
42	23.01	23.66	24.29	95.00	3.14	3.34	3.53
43	22.09	22.69	23.27	96.00	3.04	3.24	3.42
44	21.20	21.76	22.30	97.00	2.94	3.14	3.32
45	20.35	20.87	21.37	98.00	2.84	3.04	3.21
46	19.55	20.02	20.49	99.00	2.75	2.94	3.12
47	18.78	19.21	19.64	100.00	2.66	2.85	3.02
48	18.04	18.44	18.84	101.00	2.58	2.76	2.93
49	17.33	17.70	18.07	102.00	2.50	2.68	2.84
50	16.66	17.00	17.34	103.00	2.42	2.60	2.76
51	15.99	16.33	16.67	104.00	2.34	2.52	2.68
52	15.34	15.68	16.02	105.00	2.27	2.44	2.60

R80=50KΩ±3% B25/80=4450K±3%					
Temp (C)	Resistance (KΩ)			% (resist.tol)	
	Rmax	R (t) Normal	Rmin	MAX (+)	MIN (-)
0	1749.01	1921.99	2094.97	9.00	9.00
1	1651.43	1813.27	1975.10	8.93	8.93
2	1560.17	1711.65	1863.13	8.85	8.85
3	1474.74	1616.59	1758.45	8.78	8.78
4	1394.71	1527.61	1660.51	8.70	8.70
5	1319.68	1444.25	1568.82	8.63	8.63
6	1249.30	1366.10	1482.90	8.55	8.55
7	1183.21	1292.77	1402.34	8.48	8.48
8	1121.12	1223.94	1326.75	8.40	8.40
9	1062.76	1159.27	1255.77	8.33	8.33
10	1007.85	1098.47	1189.10	8.25	8.25
11	956.17	1041.29	1126.42	8.18	8.18
12	907.49	987.48	1067.46	8.10	8.10
13	861.62	936.80	1011.98	8.03	8.03
14	818.37	889.05	959.73	7.95	7.95
15	777.57	844.04	910.51	7.88	7.88
16	739.07	801.59	864.11	7.80	7.80
17	702.71	761.53	820.36	7.73	7.73
18	668.35	723.72	779.08	7.65	7.65
19	635.89	688.00	740.12	7.58	7.58
20	605.19	654.25	703.32	7.50	7.50
21	576.15	622.36	668.57	7.43	7.43
22	548.66	592.19	635.72	7.35	7.35
23	522.65	563.65	604.66	7.28	7.28
24	498.01	536.64	575.28	7.20	7.20
25	474.66	511.08	547.49	7.13	7.13
26	452.54	486.86	521.19	7.05	7.05
27	431.56	463.92	496.28	6.98	6.98
28	411.67	442.18	472.69	6.90	6.90
29	392.80	421.57	450.34	6.83	6.83
30	374.89	402.03	429.17	6.75	6.75
31	357.89	383.49	409.09	6.68	6.68
32	341.75	365.90	390.05	6.60	6.60
33	326.42	349.20	371.99	6.53	6.53
34	311.85	333.35	354.85	6.45	6.45
35	298.00	318.30	338.59	6.38	6.38
36	284.84	304.00	323.15	6.30	6.30
37	272.33	290.41	308.49	6.23	6.23
38	260.43	277.49	294.56	6.15	6.15
39	249.10	265.22	281.33	6.08	6.08
40	238.33	253.54	268.75	6.00	6.00
41	228.07	242.44	256.80	5.93	5.93
42	218.31	231.87	245.44	5.85	5.85
43	209.01	221.82	234.63	5.78	5.78
44	200.15	212.25	224.35	5.70	5.70
45	191.72	203.14	214.57	5.63	5.63
46	183.67	194.47	205.26	5.55	5.55
47	176.01	186.20	196.40	5.48	5.48
48	168.70	178.33	187.96	5.40	5.40
49	161.74	170.83	179.93	5.33	5.33
50	155.09	163.68	172.28	5.25	5.25
51	148.75	156.87	164.98	5.18	5.18
52	142.70	150.37	158.04	5.10	5.10
53	136.92	144.17	151.41	5.03	5.03
54	131.41	138.26	145.10	4.95	4.95
55	126.15	132.61	139.08	4.88	4.88
56	121.12	127.23	133.34	4.80	4.80
57	116.32	122.09	127.86	4.73	4.73
58	111.73	117.18	122.63	4.65	4.65
59	107.35	112.49	117.64	4.58	4.58
60	103.16	108.02	112.88	4.50	4.50
61	99.15	103.74	108.33	4.43	4.43
62	95.32	99.65	103.99	4.35	4.35

R80=50KΩ±3% B25/80=4450K±3%					
(C)	Resistance (KΩ)			% (resist.tol)	
	Rmax	R (t) Normal	Rmin	MAX (+)	MIN (-)
63	91.66	95.75	99.84	4.28	4.28
64	88.15	92.01	95.88	4.20	4.20
65	84.80	88.44	92.09	4.13	4.13
66	81.58	85.03	88.47	4.05	4.05
67	78.51	81.76	85.01	3.98	3.98
68	75.57	78.64	81.70	3.90	3.90
69	72.75	75.65	78.54	3.83	3.83
70	70.05	72.78	75.51	3.75	3.75
71	67.47	70.04	72.61	3.68	3.68
72	64.99	67.42	69.84	3.60	3.60
73	62.61	64.90	67.19	3.53	3.53
74	60.34	62.49	64.65	3.45	3.45
75	58.15	60.19	62.22	3.38	3.38
76	56.06	57.97	59.89	3.30	3.30
77	54.05	55.85	57.65	3.23	3.23
78	52.13	53.82	55.52	3.15	3.15
79	50.28	51.87	53.47	3.08	3.08
80	48.50	50.00	51.50	3.00	3.00
81	46.73	48.21	49.68	3.07	3.07
82	45.03	46.48	47.94	3.13	3.13
83	43.40	44.83	46.27	3.20	3.20
84	41.83	43.25	44.66	3.27	3.27
85	40.33	41.72	43.11	3.33	3.33
86	38.89	40.26	41.63	3.40	3.40
87	37.51	38.86	40.20	3.47	3.47
88	36.18	37.51	38.83	3.53	3.53
89	34.91	36.21	37.51	3.60	3.60
90	33.68	34.96	36.24	3.67	3.67
91	32.50	33.76	35.03	3.73	3.73
92	31.37	32.61	33.85	3.80	3.80
93	30.29	31.50	32.72	3.87	3.87
94	29.24	30.44	31.64	3.93	3.93
95	28.24	29.41	30.59	4.00	4.00
96	27.27	28.43	29.58	4.07	4.07
97	26.34	27.48	28.61	4.13	4.13
98	25.45	26.56	27.68	4.20	4.20
99	24.59	25.69	26.78	4.27	4.27
100	23.76	24.84	25.91	4.33	4.33
101	22.97	24.02	25.08	4.40	4.40
102	22.20	23.24	24.28	4.47	4.47
103	21.46	22.48	23.50	4.53	4.53
104	20.75	21.75	22.75	4.60	4.60
105	20.07	21.05	22.03	4.67	4.67
106	19.41	20.37	21.34	4.73	4.73
107	18.77	19.72	20.67	4.80	4.80
108	18.16	19.09	20.02	4.87	4.87
109	17.57	18.49	19.40	4.93	4.93
110	17.01	17.90	18.80	5.00	5.00
111	16.46	17.34	18.22	5.07	5.07
112	15.93	16.79	17.66	5.13	5.13
113	15.42	16.27	17.11	5.20	5.20
114	14.93	15.76	16.59	5.27	5.27
115	14.46	15.28	16.09	5.33	5.33
116	14.01	14.80	15.60	5.40	5.40
117	13.57	14.35	15.13	5.47	5.47
118	13.14	13.91	14.68	5.53	5.53
119	12.73	13.49	14.24	5.60	5.60
120	12.34	13.08	13.82	5.67	5.67
121	11.96	12.69	13.41	5.73	5.73
122	11.59	12.31	13.02	5.80	5.80
123	11.24	11.94	12.64	5.87	5.87
124	10.90	11.58	12.27	5.93	5.93
125	10.57	11.24	11.92	6.00	6.00
126	10.25	10.91	11.57	6.07	6.07
127	9.94	10.59	11.24	6.13	6.13
128	9.65	10.29	10.92	6.20	6.20
129	9.36	9.99	10.61	6.27	6.27
130	9.09	9.70	10.32	6.33	6.33
131	8.82	9.43	10.03	6.40	6.40
132	8.57	9.16	9.75	6.47	6.47
133	8.32	8.90	9.48	6.53	6.53
134	8.08	8.65	9.22	6.60	6.60
135	7.85	8.41	8.97	6.67	6.67
136	7.63	8.18	8.73	6.73	6.73
137	7.42	7.96	8.50	6.80	6.80
138	7.21	7.74	8.27	6.87	6.87
139	7.01	7.53	8.06	6.93	6.93
140	6.82	7.33	7.85	7.00	7.00

R25=10KΩ±3% B25/50=3700K±3%					
Temp (C)	Resistance (KΩ)			% (resist.tol)	
	Rmax	R (t) Normal	Rmin	MAX (+)	MIN (-)
-30	145.82	135.02	124.22	7.00	7.00
-29	138.07	129.13	120.18	6.93	6.93
-28	131.79	123.34	114.89	6.85	6.85
-27	125.67	117.68	109.70	6.78	6.78
-26	119.71	112.18	104.65	6.71	6.71
-25	113.93	106.84	99.75	6.64	6.64
-24	108.36	101.69	95.01	6.56	6.56
-23	103.00	96.72	90.44	6.49	6.49
-22	97.85	91.95	86.05	6.42	6.42
-21	92.92	87.37	81.83	6.35	6.35
-20	88.20	82.99	77.79	6.27	6.27
-19	83.70	78.82	73.93	6.20	6.20
-18	79.42	74.83	70.25	6.13	6.13
-17	75.34	71.04	66.74	6.05	6.05
-16	71.47	67.44	63.40	5.98	5.98
-15	67.80	64.02	60.23	5.91	5.91
-14	64.32	60.77	57.22	5.84	5.84
-13	61.02	57.69	54.37	5.76	5.76
-12	57.90	54.78	51.66	5.69	5.69
-11	54.94	52.02	49.10	5.62	5.62
-10	52.15	49.41	46.67	5.55	5.55
-9	49.51	46.94	44.37	5.47	5.47
-8	47.02	44.61	42.20	5.40	5.40
-7	44.66	42.40	40.14	5.33	5.33
-6	42.43	40.32	38.20	5.25	5.25
-5	40.33	38.35	36.36	5.18	5.18
-4	38.35	36.48	34.62	5.11	5.11
-3	36.47	34.72	32.97	5.04	5.04
-2	34.70	33.06	31.42	4.96	4.96
-1	33.03	31.49	29.95	4.89	4.89
0	31.45	30.00	28.56	4.82	4.82
1	29.95	28.59	27.24	4.75	4.75
2	28.54	27.26	25.99	4.67	4.67
3	27.20	26.01	24.81	4.60	4.60
4	25.94	24.82	23.69	4.53	4.53
5	24.74	23.69	22.63	4.45	4.45
6	23.61	22.62	21.63	4.38	4.38
7	22.54	21.61	20.68	4.31	4.31
8	21.52	20.65	19.77	4.24	4.24
9	20.56	19.74	18.92	4.16	4.16
10	19.65	18.87	18.10	4.09	4.09
11	18.78	18.05	17.33	4.02	4.02
12	17.96	17.28	16.59	3.95	3.95
13	17.18	16.54	15.90	3.87	3.87
14	16.44	15.83	15.23	3.80	3.80
15	15.73	15.17	14.60	3.73	3.73
16	15.06	14.53	14.00	3.65	3.65
17	14.42	13.93	13.43	3.58	3.58
18	13.82	13.35	12.88	3.51	3.51
19	13.24	12.80	12.36	3.44	3.44
20	12.69	12.28	11.86	3.36	3.36
21	12.17	11.78	11.39	3.29	3.29
22	11.67	11.30	10.94	3.22	3.22
23	11.19	10.85	10.51	3.15	3.15
24	10.73	10.41	10.09	3.07	3.07
25	10.30	10.00	9.70	3.00	3.00
26	9.90	9.60	9.31	3.06	3.06
27	9.51	9.23	8.94	3.13	3.13
28	9.15	8.86	8.58	3.19	3.19
29	8.80	8.52	8.24	3.25	3.25
30	8.46	8.19	7.92	3.31	3.31
31	8.14	7.87	7.61	3.38	3.38
32	7.83	7.57	7.31	3.44	3.44
33	7.53	7.28	7.02	3.50	3.50
34	7.25	7.00	6.75	3.56	3.56
35	6.98	6.73	6.49	3.63	3.63
36	6.72	6.48	6.24	3.69	3.69
37	6.47	6.23	6.00	3.75	3.75

R25=10KΩ±3% B25/50=3700K±3%					
Temp (C)	Resistance (KΩ)			% (resist.tol)	
	Rmax	R (t) Normal	Rmin	MAX (+)	MIN (-)
38	6.23	6.00	5.77	3.81	3.81
39	6.00	5.77	5.55	3.88	3.88
40	5.78	5.56	5.34	3.94	3.94
41	5.56	5.35	5.14	4.00	4.00
42	5.36	5.15	4.94	4.06	4.06
43	5.17	4.96	4.76	4.13	4.13
44	4.98	4.78	4.58	4.19	4.19
45	4.80	4.60	4.41	4.25	4.25
46	4.63	4.43	4.24	4.31	4.31
47	4.46	4.27	4.09	4.38	4.38
48	4.30	4.12	3.94	4.44	4.44
49	4.15	3.97	3.79	4.50	4.50
50	4.00	3.83	3.65	4.56	4.56
51	3.86	3.69	3.52	4.63	4.63
52	3.72	3.56	3.39	4.69	4.69
53	3.59	3.43	3.27	4.75	4.75
54	3.47	3.31	3.15	4.81	4.81
55	3.35	3.19	3.04	4.88	4.88
56	3.23	3.08	2.93	4.94	4.94
57	3.12	2.97	2.83	5.00	5.00
58	3.02	2.87	2.73	5.06	5.06
59	2.91	2.77	2.63	5.13	5.13
60	2.82	2.68	2.54	5.19	5.19
61	2.72	2.59	2.45	5.25	5.25
62	2.63	2.50	2.36	5.31	5.31
63	2.54	2.41	2.28	5.38	5.38
64	2.46	2.33	2.21	5.44	5.44
65	2.38	2.26	2.13	5.50	5.50
66	2.30	2.18	2.06	5.56	5.56
67	2.23	2.11	1.99	5.63	5.63
68	2.16	2.04	1.92	5.69	5.69
69	2.09	1.97	1.86	5.75	5.75
70	2.02	1.91	1.80	5.81	5.81
71	1.96	1.85	1.74	5.88	5.88
72	1.90	1.79	1.69	5.94	5.94
73	1.84	1.74	1.63	6.00	6.00
74	1.78	1.68	1.58	6.06	6.06
75	1.73	1.63	1.53	6.13	6.13
76	1.68	1.58	1.48	6.19	6.19
77	1.63	1.53	1.43	6.25	6.25
78	1.58	1.48	1.39	6.31	6.31
79	1.53	1.44	1.35	6.38	6.38
80	1.49	1.40	1.31	6.44	6.44
81	1.44	1.36	1.27	6.50	6.50
82	1.40	1.32	1.23	6.56	6.56
83	1.36	1.28	1.19	6.63	6.63
84	1.32	1.24	1.16	6.69	6.69
85	1.29	1.20	1.12	6.75	6.75
86	1.25	1.17	1.09	6.81	6.81
87	1.21	1.14	1.06	6.88	6.88
88	1.18	1.10	1.03	6.94	6.94
89	1.15	1.07	1.00	7.00	7.00
90	1.12	1.04	0.97	7.06	7.06
91	1.09	1.01	0.94	7.13	7.13
92	1.06	0.99	0.91	7.19	7.19
93	1.03	0.96	0.89	7.25	7.25
94	1.00	0.93	0.86	7.31	7.31
95	0.97	0.90	0.84	7.38	7.38
96	0.94	0.88	0.81	7.44	7.44
97	0.92	0.85	0.79	7.50	7.50
98	0.89	0.83	0.77	7.56	7.56
99	0.87	0.81	0.75	7.63	7.63
100	0.84	0.78	0.72	7.69	7.69
101	0.82	0.76	0.70	7.75	7.75
102	0.80	0.74	0.68	7.81	7.81
103	0.77	0.72	0.66	7.88	7.88
104	0.75	0.69	0.64	7.94	7.94
105	0.73	0.67	0.62	8.00	8.00

R25=23KΩ±3% B25/50=4200K±3%					
Temp (°C)	Resistance (KΩ)			% (resist.tol)	
	Rmax	R (t) Normal	Rmin	MAX (+)	MIN (-)
-30	538.77	513.12	487.46	5.00	5.00
-29	502.58	478.89	455.21	4.95	4.95
-28	469.29	447.41	425.53	4.89	4.89
-27	438.61	418.38	398.15	4.84	4.84
-26	410.29	391.56	372.84	4.78	4.78
-25	384.09	366.75	349.41	4.73	4.73
-24	359.82	343.75	327.69	4.67	4.67
-23	337.30	322.41	307.52	4.62	4.62
-22	316.38	302.57	288.76	4.56	4.56
-21	296.92	284.11	271.29	4.51	4.51
-20	278.79	266.91	255.02	4.45	4.45
-19	261.90	250.87	239.83	4.40	4.40
-18	246.15	235.90	225.64	4.35	4.35
-17	231.43	221.91	212.39	4.29	4.29
-16	217.69	208.84	199.99	4.24	4.24
-15	204.83	196.61	188.39	4.18	4.18
-14	192.81	185.16	177.52	4.13	4.13
-13	181.55	174.44	167.34	4.07	4.07
-12	171.01	164.40	157.79	4.02	4.02
-11	161.13	154.98	148.84	3.96	3.96
-10	151.87	146.15	140.44	3.91	3.91
-9	143.18	137.87	132.56	3.85	3.85
-8	135.04	130.10	125.15	3.80	3.80
-7	127.40	122.80	118.20	3.75	3.75
-6	120.23	115.95	111.67	3.69	3.69
-5	113.49	109.51	105.53	3.64	3.64
-4	107.17	103.46	99.76	3.58	3.58
-3	101.23	97.78	94.33	3.53	3.53
-2	95.65	92.44	89.23	3.47	3.47
-1	90.40	87.42	84.43	3.42	3.42
0	85.47	82.69	79.91	3.36	3.36
1	80.84	78.25	75.66	3.31	3.31
2	76.48	74.07	71.66	3.25	3.25
3	72.38	70.13	67.89	3.20	3.20
4	68.52	66.43	64.34	3.15	3.15
5	64.89	62.94	61.00	3.09	3.09
6	61.47	59.66	57.85	3.04	3.04
7	58.25	56.57	54.88	2.98	2.98
8	55.22	53.65	52.08	2.93	2.93
9	52.37	50.90	49.44	2.87	2.87
10	49.68	48.31	46.95	2.82	2.82
11	47.14	45.87	44.60	2.76	2.76
12	44.75	43.57	42.39	2.71	2.71
13	42.49	41.40	40.30	2.65	2.65
14	40.37	39.34	38.32	2.60	2.60
15	38.36	37.41	36.45	2.55	2.55
16	36.46	35.58	34.69	2.49	2.49
17	34.67	33.85	33.02	2.44	2.44
18	32.98	32.22	31.45	2.38	2.38
19	31.39	30.67	29.96	2.33	2.33
20	29.87	29.21	28.55	2.27	2.27
21	28.45	27.83	27.21	2.22	2.22
22	27.10	26.52	25.95	2.16	2.16
23	25.82	25.28	24.75	2.11	2.11
24	24.61	24.11	23.62	2.05	2.05
25	23.46	23.00	22.54	2.00	2.00
26	22.40	21.95	21.50	2.04	2.04
27	21.39	20.95	20.51	2.09	2.09
28	20.43	20.00	19.58	2.13	2.13
29	19.52	19.10	18.69	2.18	2.18
30	18.66	18.25	17.85	2.22	2.22
31	17.84	17.44	17.05	2.26	2.26
32	17.06	16.67	16.29	2.31	2.31
33	16.32	15.94	15.57	2.35	2.35
34	15.61	15.25	14.88	2.39	2.39
35	14.94	14.59	14.23	2.44	2.44
36	14.31	13.96	13.61	2.48	2.48
37	13.70	13.36	13.03	2.53	2.53

R25=23KΩ±3% B25/50=4200K±3%					
Temp (°C)	Resistance (KΩ)			% (resist.tol)	
	Rmax	R (t) Normal	Rmin	MAX (+)	MIN (-)
38	13.12	12.79	12.47	2.57	2.57
39	12.57	12.25	11.93	2.61	2.61
40	12.05	11.74	11.42	2.66	2.66
41	11.55	11.24	10.94	2.70	2.70
42	11.07	10.78	10.48	2.74	2.74
43	10.62	10.33	10.04	2.79	2.79
44	10.18	9.90	9.62	2.83	2.83
45	9.77	9.50	9.22	2.88	2.88
46	9.38	9.11	8.84	2.92	2.92
47	9.00	8.74	8.48	2.96	2.96
48	8.64	8.39	8.14	3.01	3.01
49	8.30	8.05	7.80	3.05	3.05
50	7.97	7.73	7.49	3.09	3.09
51	7.65	7.42	7.19	3.14	3.14
52	7.35	7.13	6.90	3.18	3.18
53	7.07	6.85	6.63	3.23	3.23
54	6.79	6.58	6.36	3.27	3.27
55	6.53	6.32	6.11	3.31	3.31
56	6.28	6.08	5.87	3.36	3.36
57	6.04	5.84	5.64	3.40	3.40
58	5.81	5.62	5.43	3.44	3.44
59	5.59	5.40	5.22	3.49	3.49
60	5.38	5.20	5.02	3.53	3.53
61	5.18	5.00	4.82	3.58	3.58
62	4.99	4.82	4.64	3.62	3.62
63	4.81	4.64	4.47	3.66	3.66
64	4.63	4.46	4.30	3.71	3.71
65	4.46	4.30	4.14	3.75	3.75
66	4.30	4.14	3.99	3.79	3.79
67	4.15	3.99	3.84	3.84	3.84
68	4.00	3.85	3.70	3.88	3.88
69	3.86	3.71	3.56	3.93	3.93
70	3.72	3.58	3.44	3.97	3.97
71	3.59	3.45	3.31	4.01	4.01
72	3.47	3.33	3.20	4.06	4.06
73	3.35	3.22	3.08	4.10	4.10
74	3.23	3.10	2.98	4.14	4.14
75	3.12	3.00	2.87	4.19	4.19
76	3.02	2.90	2.77	4.23	4.23
77	2.92	2.80	2.68	4.28	4.28
78	2.82	2.70	2.59	4.32	4.32
79	2.73	2.61	2.50	4.36	4.36
80	2.64	2.53	2.42	4.41	4.41
81	2.56	2.45	2.34	4.45	4.45
82	2.47	2.37	2.26	4.49	4.49
83	2.39	2.29	2.19	4.54	4.54
84	2.32	2.22	2.12	4.58	4.58
85	2.25	2.15	2.05	4.63	4.63
86	2.18	2.08	1.98	4.67	4.67
87	2.11	2.02	1.92	4.71	4.71
88	2.05	1.95	1.86	4.76	4.76
89	1.98	1.89	1.80	4.80	4.80
90	1.92	1.83	1.75	4.84	4.84
91	1.87	1.78	1.69	4.89	4.89
92	1.81	1.72	1.64	4.93	4.93
93	1.76	1.67	1.59	4.98	4.98
94	1.70	1.62	1.54	5.02	5.02
95	1.65	1.57	1.49	5.06	5.06
96	1.60	1.52	1.45	5.11	5.11
97	1.55	1.48	1.40	5.15	5.15
98	1.51	1.43	1.36	5.19	5.19
99	1.46	1.39	1.32	5.24	5.24
100	1.42	1.35	1.28	5.28	5.28
101	1.37	1.31	1.24	5.33	5.33
102	1.33	1.26	1.20	5.37	5.37
103	1.29	1.22	1.16	5.41	5.41
104	1.25	1.18	1.12	5.46	5.46
105	1.21	1.15	1.08	5.50	5.50

3. Enthalpy-humidity chart

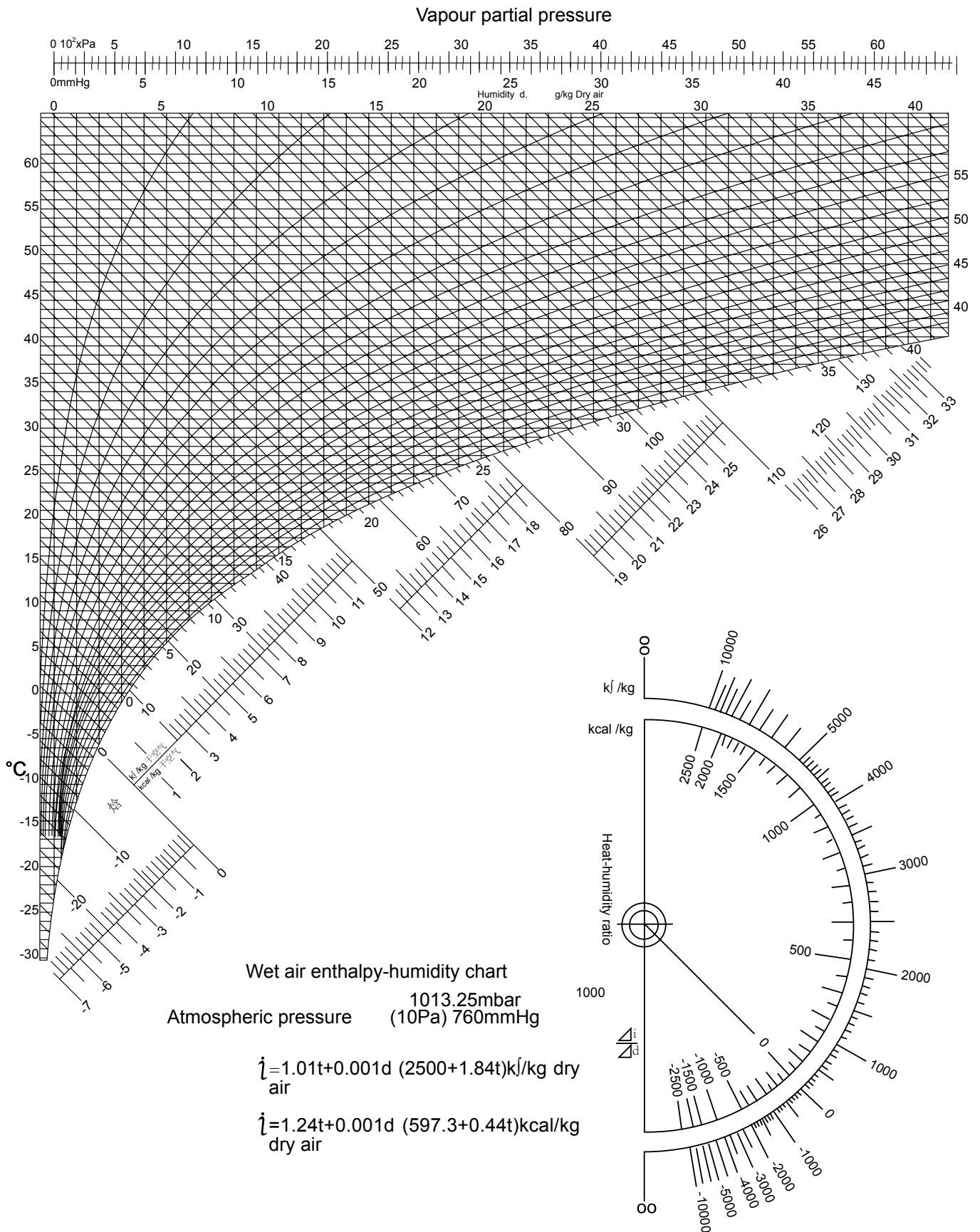

Airwell

CLIMATISATION ET CHAUFFAGE

WARNING :

The design and specifications are subject to change without prior notice for product improvement. Consult with the sales agency or manufacturer for details.

ATTENTION :

Le design et les données techniques sont donnés à titre indicatif et peuvent être modifiés sans préavis.



AIRWELL RESIDENTIAL SAS

10,Rue du Fort de Saint Cyr,
78180 Montigny le Bretonneux- France
www.airwell-res.com