

Airwell

Just feel well

FLOWLOGIC

Range of variable refrigerant
flow (VRF) solutions



VRF Range

Outdoor groups

MODEL NAME		Fluid type	Page	Capacity (HP)	Cooling power (kW)	Heating power (kW)		
 MINI FLOWLOGIC II	YCV080		R410A	8	3	8	9.5	
	YCV125		R410A	8	4	12.5	14	
	YCV150				5	15	17	
	YCV180				6	18	20	
	YCVFD280					R410A	8	10
	YCVFD335	10	28	31.5				
	FLOWLOGIC III	YDV280		R410A	10	10	28	31.5
		YDV335						
YDV400		14				40	45	
YDV450		16				45	50	
YDV504			R410A	10	18	50.4	56.5	
YDV560					20	56	63	
YDV615								
YDV680					24	68	73	
FLOWLOGIC II HR	YCV280HR		R410A	20	10	28	31.5	
	YCV335HR		R410A	20	12	33.5	37.5	
	YCV400HR				14	40	45	
	YCV450HR				16	45	50	
WATER FLOWLOGIC	YWC220		R410A	28	22.4	8	25.0	
	YWC280				28.0	10	31.5	
	YWC335				33.5	12	37.5	

- **Wide range of power:**
from 3 to 72 HP (from 8 to 204 kW)
- **Silent system**
- **Compact solution:** small footprint
- **High performance:** COP until 4.5
- **Certified Eurovent**



VRF Range Indoor units

MODEL NAME			Fluid type	Page
HIGH WALL	HBV		R410A	30
CASSETTE 600X600	CBV		R410A	31
CASSETTE 900X900	CCV		R410A	32
360° CASSETTE	 NEW CFV		R410A	33
FLOOR CEILING	FAV		R410A	34
DUCTED LOW STATIC PRESSURE	 NEW DDV		R410A	35
DUCTED MEDIUM STATIC PRESSURE	 UPGRADE DBV		R410A	36
DUCTED HIGH STATIC PRESSURE	DCV		R410A	37
CONSOLE	 UPGRADE EAV		R410A	38
AHU CONNECTION KIT				40

Capacity (kBtu/h)	5	7	9	12	16	18	24	28	30	38	48	60	72	96	192
Capacity (HP)	0.5	0.75	1.25	1.5	1.75	2.25	3	3.5	3.75	4.75	6	7	9	12	24
Cooling (kW)	1.5	2.2	2.8	3.6	4.5	5.6	7.1	8	9	11.2	14	16	22.6	28	56
Heating (kW)	1.7	2.5	3.2	4	5	6.3	8	9	10	12.5	16	18	25	31.5	63

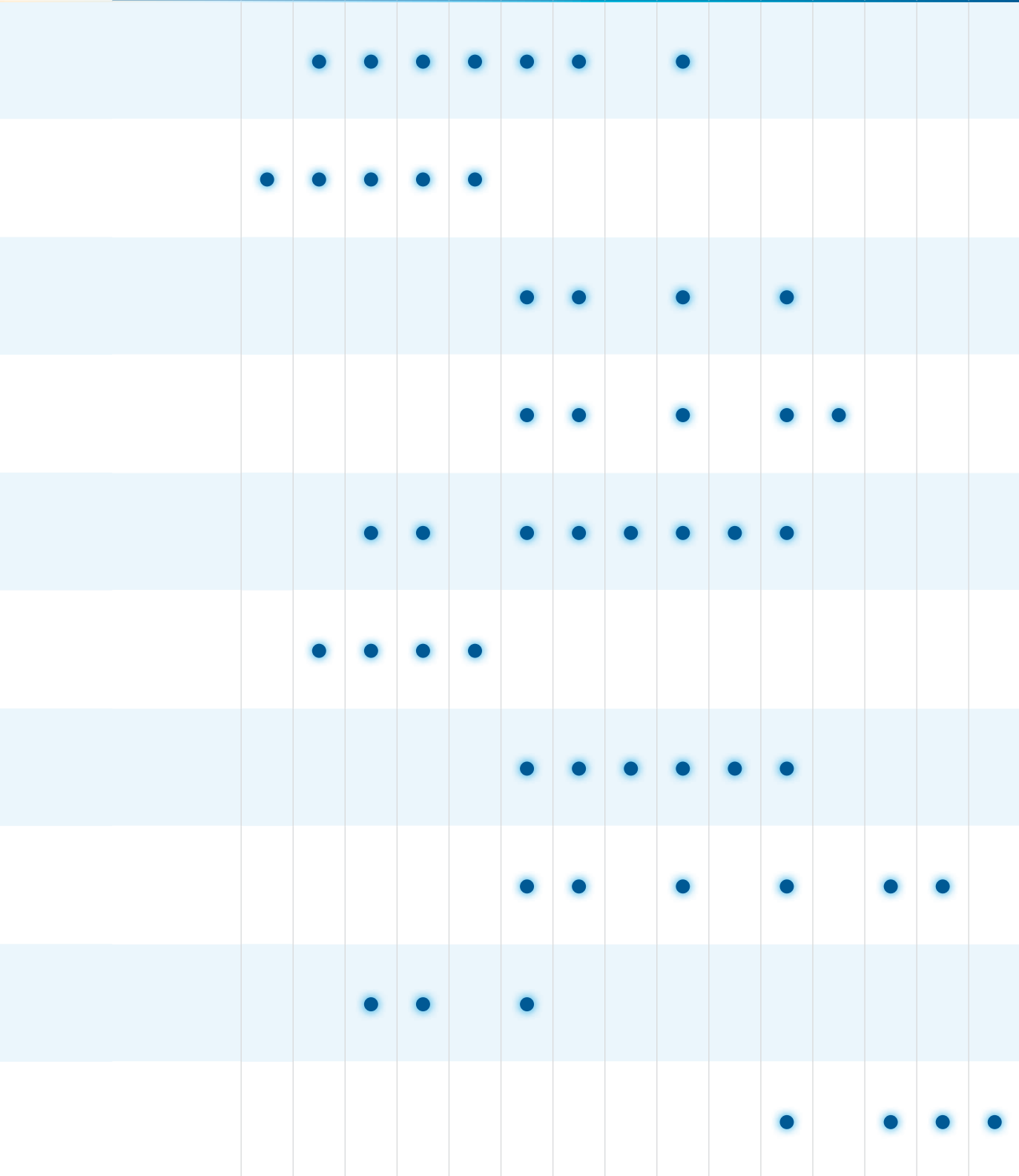

Why choosing a VRF system?



■ One system for multiple applications



Shopping centers



Villas



Hostels



Offices

■ Extrem versatility

- All seasons
- Immediate change mode (heating/cooling)
- Extendable system
- Any indoor unit
- Anti-corrosion treatment on demand

Blygold®



HIGH WALL HBV



CASSETTE 600x600 CBV



CASSETTE 900x900 CCV



360° CASSETTE CFV



FLOOR CEILING FAV



DUCTED LOW STATIC PRESSURE DDV



DUCTED MEDIUM STATIC PRESSURE DBV



DUCTED HIGH STATIC PRESSURE DCV



CONSOLE EAV



AHU CONNECTION KIT

■ Easy installation

- Professional selection software
- Easy setup (piping, electricity, regulation...)
- Ideal solution for refurbishment (easy installation also in inhabited places)

Why choosing an Airwell VRF system?

- Wide range of power: from 3 to 72 HP (from 8 to 204 kW)
- Silent system
- Compact solution: small footprint
- High performance: COP until 4.5
- Certified Eurovent 

Performant system

USE HIGH EFFICIENCY DC INVERTER SCROLL COMPRESSOR, HIGH EFFICACITY, LOW NOISE

The highly efficient Scroll compressor is equipped with a “Framen Compliance Mechanism” that allows movement in the axial direction of the frame supporting the cradle Scroll. This greatly reduces both leakage and friction loss, ensuring very high efficiency throughout the speed range.



HIGH EFFICIENCY DC FAN MOTOR

The speed of wide range DC fan motor can be adjusted from 0 to 1000 tr/min.

Compared to conventional AC motors, a DC fan motor offers greater operating efficiency, especially during low speed rotation. The efficiency could be 90%.



HEAT EXCHANGER ADOPTS THE SUBCOOLING TECHNOLOGY: HIGH EFFICIENCY

- The system is cooled with little refrigerant.
 - Improve subcooling degree of refrigerant.
 - Avoid energy loss due to refrigerant flash evaporating when it goes through PMV.
 - W-model Ø8 innergrooved tube.
 - Hydrophilic aluminium coil fin, it will increase efficiency of heat exchange by 5%.
- **Increase cooling power by 6%.**
- **Reduce refrigerant circulation amounts.**

Increase the efficiency of system



PRECISE CONTROL

PID control adjusts the output of compressor and the open degree of EEV, balances the indoor refrigerant flow, realizes the linear output, creates a comfortable environment. The temperature can be controlled precisely.

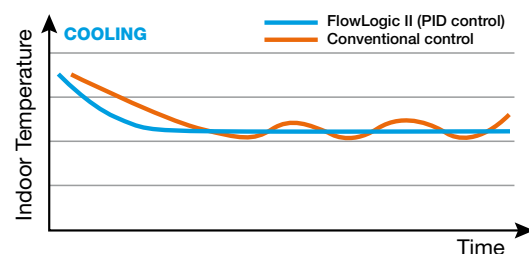



+ PRODUCTS

- COP can reach 4.2.
- Compact (0.32 m² footprint).
- Easy maintenance.



RWV06
(optional)



RWV08
(optional)

FEATURES

TECHNOLOGY:



R410A FLUID



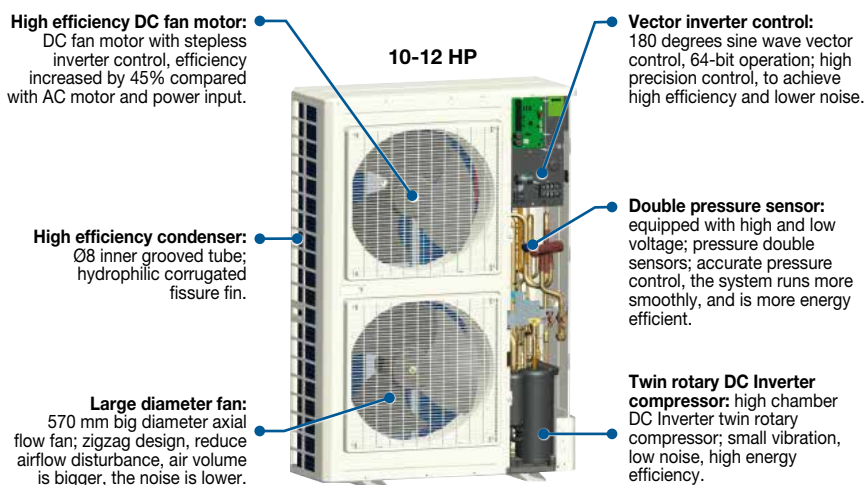
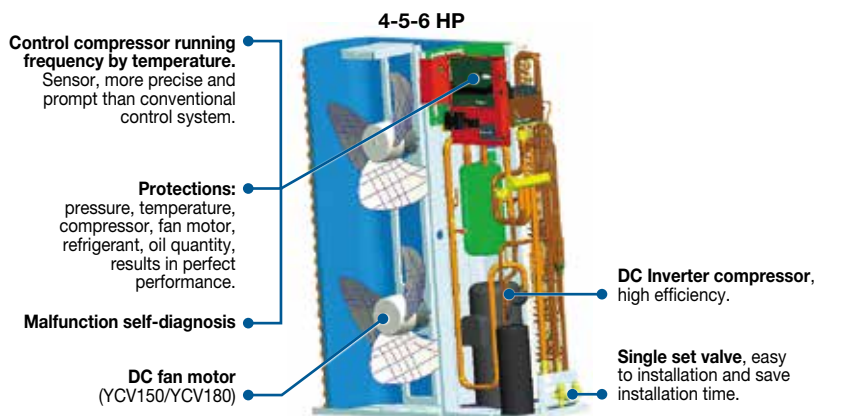

DC INVERTER

- Capacity range: 3-4-5-6-10-12 HP.
- Designed for residential use or for light commercial use.
- Minimum outdoor temperature for heating mode operation -15°C.
- Minimum outdoor temperature for cooling mode operation -5°C.
- DC Inverter compressor and ventilator.
- Refrigerant simple pipe length up to 300 m.
- Capacity ratio 50-130%.



MINI FLOWLOGIC II TECHNICAL DATA

Outdoor unit	AWAU-YCV080-H11	AWAU-YCV125-H11	AWAU-YCV150-H11	AWAU-YCV150-H13	AWAU-YCV180-H13	AWAU-YCVFD280-H13	AWAU-YCVFD335-H13	
Phase	Single phase	Single phase	Single phase	Three phase	Three phase	Three phase	Three phase	
Part number	7SP14H045	7SP14H041	7SP14H042	7SP14H044	7SP14H043	7SP14H011	7SP14H012	
								
RATED POWER								
Cooling	kW	8	12.5	15	15	18	28	33.5
EER		3.64	3.79	3.77	3.77	3.47	3.5	3.44
Seasonal energy efficiency		210			202	181	274	3.9
Heating	kW	9.5	14	17	17	20	31.5	37.5
COP		4.31	4.12	4.35	4.35	3.9	4.2	
Seasonal energy efficiency		144			137	133	199	
ELECTRICAL PARAMETERS								
Phase/Tension/Frequency		1P/220-240/50Hz/N	1P/220-240/50-60Hz/N		3P/400V/50Hz/N		3P/380-400V/50-60Hz/N	
Cooling rated power input	kW	2.20	3.30	3.98	3.98	5.19	8	9.75
Heating rated power input	kW	2.20	3.40	3.91	3.91	5.13	7.5	9.62
Max. current	A	18.9	34.1	34.1	11.2	11.6	23.8	26
PERFORMANCE								
Airflow (HS)	m³/h	3500	6500	6500	6500	6500	10000	10000
Sound pressure level (HS)	dB(A)	54	57	58	58	59		60
Sound power level (HS)	dB(A)	65	68	69	69	70	58	71
INSTALLATION								
External dimensions (WxHxD)	mm	960x830x340	960x1250x340	960x1250x340	960x1250x340	960x1250x340	1050x1636x400	1050x1636x400
Shipping dimensions (WxHxD)	mm	1095x945x410	1095x1400x410	1095x1400x410	1095x1400x410	1095x1400x410	1150x1790x510	1150x1795x510
Net weight/Gross weight	kg	70/76	99/107	99/107	99/107	99/107	168/183	168/183
Compressor type		Rotary	Rotary	Rotary	Rotary	Rotary	Scroll	Rotary
Liquid pipe diameter	inches	3/8"	3/8"	3/8"	3/8"	3/8"	1/2"	1/2"
Suction pipe diameter	inches	5/8"	3/4"	3/4"	3/4"	3/4"	7/8"	1"
Max. pipe length	m	100	150	150	150	150	300	300
Max. height between indoor and outdoor units*	m	30	30	30	30	30	50	50
Maximum indoor units connectable	quantity	4	8	8	8	9	16	16
OPERATING LIMITS								
Cooling	°C	10°/48°	-5°/48°	-5°/48°	-5°/48°	-5°/48°	-5°/43°	-5°/43°
Heating	°C	-15°/21°	-15°/21°	-15°/21°	-15°/21°	-15°/21°	-15°/21°	-15°/21°
PIPE LINE								
Refrigerant/GWP		R410A/2088	R410A/2088	R410A/2088	R410A/2088	R410A/2088	R410A/2088	R410A/2088
Charge (0 m)	kg	2.4	3.8	3.8	3.8	3.8	7.4	7,4

* 30 m if the outdoor unit is above indoor unit, 20 m if the outdoor unit is below indoor unit.

TUBING ACCESSORIES

Accessory	Part number	Code	Photo	Function	Comment
Manifold pipe (gas + liquid)	7ACFHH001	TAU335		Refrigerant gathering	33.5 kW > Total indoor units power
	7ACFHH002	TAU506		Refrigerant gathering	33.5 kW ≤ Total indoor units power < 50.6 kW
	7ACFHH003	TAU730		Refrigerant gathering	50.6 kW ≤ Total indoor units power < 73 kW
	7ACFHH004	TAU1350		Refrigerant gathering	73 kW ≤ Total indoor units power < 135 kW
	7ACFHH015	TAU2040		Refrigerant gathering	135 kW ≤ Total indoor units power



+ PRODUCTS

- COP can reach 4.45.
- Compact (0.97 m² footprint).
- Large capacity range (single and combination).
- DC Inverter compressor and ventilator.



RWW06
(optional)



RWW08
(optional)

FEATURES

TECHNOLOGY:



R410A FLUID



DC INVERTER



- Capacity range from 10 to 72 HP.
- Capacity range until 24 HP with only one unit.
- Designed for all commercial uses.
- Minimum outdoor temperature for heating mode operation -23°C.
- Minimum outdoor temperature for cooling mode operation -5°C.
- Refrigerant simple pipe length up to 1000 m.
- Capacity ratio 50-130%.
- Certified Eurovent.



TUBING ACCESSORIES

Accessory	Part number	Code	Photo	Function	Comment
Gather pipe kit for 2 outdoor groups	7ACFHH013	TBS20		Refrigerant gathering	For 2 outdoor groups
Gather pipe kit for 3 outdoor groups	7ACFHH014	TBS30		Refrigerant gathering	For 3 outdoor groups
Manifold pipe (gas + liquid)	7ACFHH001	TAU335		Refrigerant gathering	33.5 kW > Total indoor units power
	7ACFHH002	TAU506		Refrigerant gathering	33.5 kW ≤ Total indoor units power < 50.6 kW
	7ACFHH003	TAU730		Refrigerant gathering	50.6 kW ≤ Total indoor units power < 73 kW
	7ACFHH004	TAU1350		Refrigerant gathering	73 kW ≤ Total indoor units power < 135 kW
	7ACFHH015	TAU2040		Refrigerant gathering	135 kW ≤ Total indoor units power

HIGH MODULARITY: LONG PIPE LENGTH, HIGH HEIGHT DROP

Refrigerant simple pipe length up to 1000 m

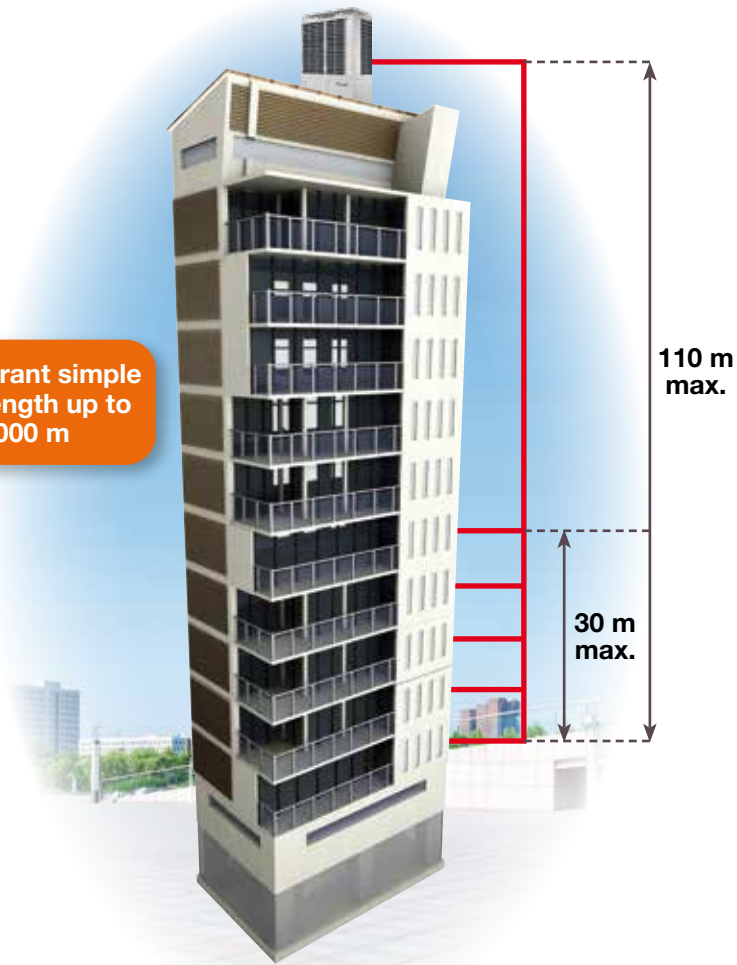

- Floor area optimized for all the product range (same foot print for all modules: 0.97 m²)
- One of the smallest footprint on market.

- Full DC inverter
- 2 x Full DC Inverter



→ 0.97 m²



■ **High static pressure outdoor unit:**
82 Pa, long air duct



Hidden solution:
installation of
outdoor unit in a
technical room

■ **Wide operation range**

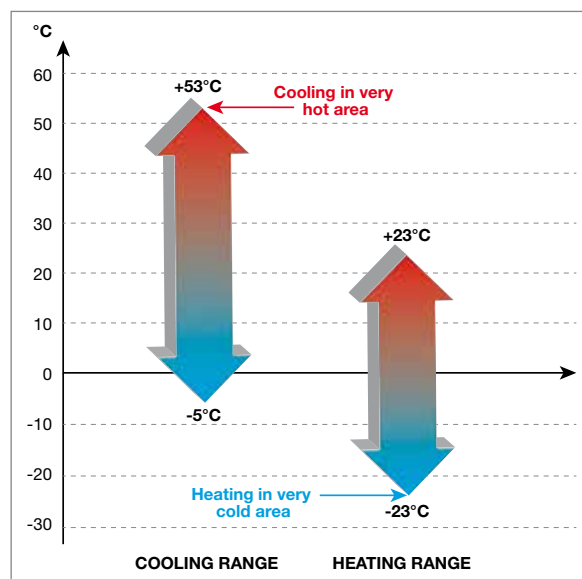

→ **Specific design:**

- Double EEV
- Two-piece condenser
- Independent electrical box

→ **Reliability/Maintenance:**

- Compressor double protection: two pressure sensors
- Double oil temperature sensor
- Large volume gas-liquid separator (26L) + liquid storage tank (10L)
- Two floor structure (no air bypass during maintenance): efficient measures

→ **Fan:**

- Optimized fan to reduce air vibration
- DC fan to optimize efficiency
- 82 Pa static pressure

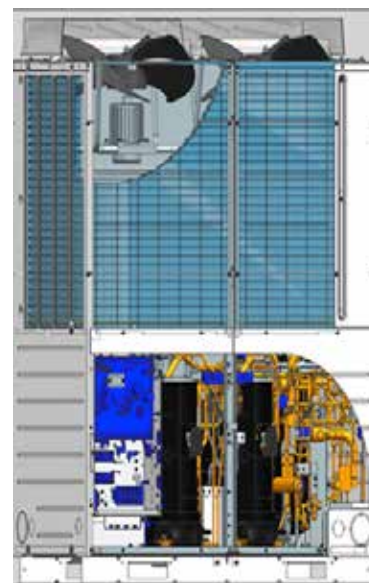

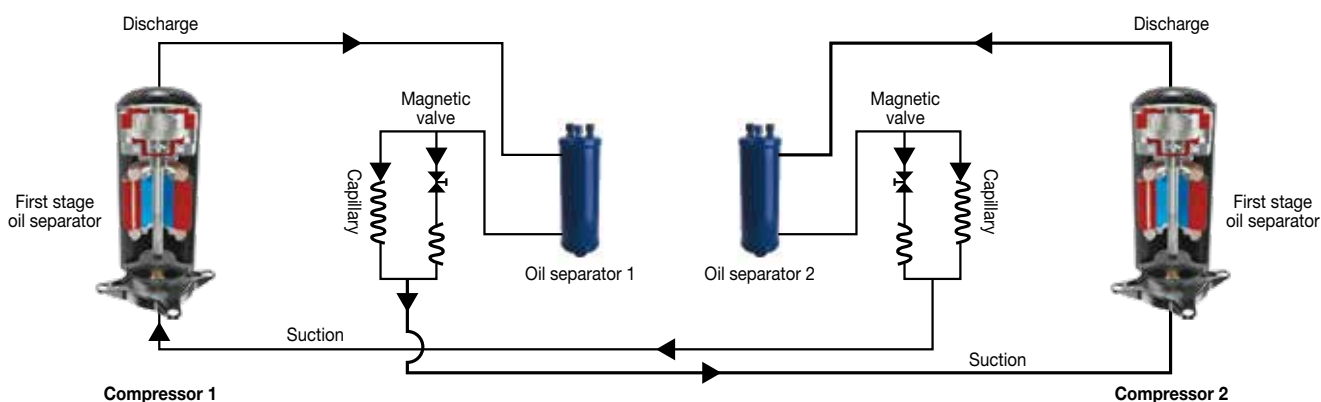

■ **Specific oil return**

- Magnetic valve
- If the compressor operate at low frequency, oil return is only with capillary.
- If the compressor operate at higher frequency, PCB control magnetic valve to improve oil return.



FLOWLOGIC III TECHNICAL DATA

Outdoor unit	Drop only					Drop only		
	AWAU-YDV 280-H13	AWAU-YDV 335-H13	AWAU-YDV 400-H13	AWAU-YDV 450-H13	AWAU-YDV 504-H13	AWAU-YDV 560-H13	AWAU-YDV 615-H13	AWAU-YDV 680-H13
Part number	7SP14H030	7HP14H031	7SP14H032	7SP14H033	7SP14H034	7SP14H035	7SP14H036	7SP14H037
Outdoor unit Tropicalized version - Drop only	AW-YDV 280TR-H13	AW-YDV 335TR-H13	AW-YDV 400TR-H13	AW-YDV 450TR-H13	AW-YDV 504TR-H13	AW-YDV 560TR-H13	AW-YDV 615TR-H13	AW-YDV 680TR-H13
Part number	7SP14H058	7SP14H059	7SP14H060	7SP14H061	7SP14H062	7SP14H063	7SP14H064	7SP14H065
Phase	Three phase	Three phase	Three phase	Three phase	Three phase	Three phase	Three phase	Three phase
								

POWERS

Capacity range	HP	10	12	14	16	18	20	22	24
Cooling	kW	28	33.5	40	45	50.4	56	61.5	68
Heating	kW	31.5	37.5	45	50	56.5	63	69	73

ELECTRICAL PARAMETERS

Phase/Tension/Frequency		3P/380-400V/50-60Hz/N								
Cooling	Rated power input	kW	7.00	8.59	10.26	11.90	13.62	15.56	17.57	19.71
	Power input max.	kW	14.38	14.73	16.91	22.68	22.10	25.19	30.56	37.47
	Rated current	A	11.56	14.19	16.94	19.66	22.50	25.69	29.02	32.55
	Current max.	A	23.68	25.1	28.40	36.80	36.15	41.10	49.65	60.65
Heating	Rated power input	kW	7.08	8.72	10.71	12.05	13.95	15.95	18.16	19.47
	Power input max.	kW	13.23	13.68	15.60	17.20	22.68	25.19	27.72	28.62
	Rated current	A	11.69	14.40	17.69	19.90	23.04	26.34	29.99	32.15
	Current max.	A	21.79	22.1	25.20	27.88	37.80	42.00	46.05	47.40
EER		4.00	3.90	3.90	3.78	3.70	3.60	3.50	3.45	
Seasonal energy efficiency		274	269	255	236	242	233	229	223	
COP		4.45	4.30	4.20	4.15	4.05	3.95	3.80	3.75	
Seasonal energy efficiency		199	193	185	163	165	163	154	149	

PERFORMANCE



Airflow	Heating	m³/h	15000	15000	15000	15600	16200	16200	16200	16200
	Cooling	m³/h	13200	13200	13200	14400	15000	15000	15000	15000
Sound pressure level to 1 m		dB(A)	57	59	59.5	61	62	62	62	63
Sound power level		dB(A)	73	75	76	77	79	79	79	80

INSTALLATION

Dimensions (WxHxD)	mm	1350x1690x720	1350x1690x720	1350x1690x720	1350x1690x720	1350x2048x720	1350x2048x720	1350x2048x720	1350x2048x720	
Refrigerant/GWP		R410A/2088								
Refrigerant charge	kg	9.7	9.7	10	10	10	10	10	10	
Net weight/Gross weight	kg	276/301	276/301	279/304	321/346	335/360	335/360	359/384	359/384	
Compressor type		Scroll								
Tubing	Liquid pipe diameter	inches	3/8"	1/2"	1/2"	1/2"	5/8"	5/8"	5/8"	5/8"
	Suction pipe diameter	inches	7/8"	1"	1"	1"1/8	1"1/8	1"1/8	1"1/8	1"1/8
	Oil equalization pipe	inches	3/8"	3/8"	3/8"	3/8"	3/8"	3/8"	3/8"	3/8"
	Max. tube length	m	1000							
Max. height between indoor and outdoor units (ODU up/down)	m	50/40								
Max. height between indoor units	m	18								
External static pressure	Pa	82								
Environment temperature range	Cooling	°C -5°/50°								
	Heating	°C -23°/21°								
Maximum indoor units connectable	quantity	20	24	29	33	37	41	45	49	



TECHNICAL DATA FOR TWO COMBINATIONS

Outdoor unit	Drop only					
	YDV735-H13	YDV800-H13	YDV850-H13	YDV904-H13	YDV950-H13	YDV1010-H13
Phase	Three phase	Three phase	Three phase	Three phase	Three phase	Three phase
Combinations part number	YDV335 / 7SP14H031	YDV400 / 7SP14H032	YDV400 / 7SP14H032	YDV400 / 7SP14H032	YDV450 / 7SP14H033	YDV450 / 7SP14H033
	YDV400 / 7SP14H032	YDV400 / 7SP14H032	YDV450 / 7SP14H033	YDV504 / 7SP14H034	YDV504 / 7SP14H034	YDV560 / 7SP14H035
						

POWERS

	HP	26	28	30	32	34	36
Capacity range							
Cooling	kW	73.5	80	85	90.4	95.4	101
Heating	kW	82.5	90	95	101.5	106.5	113

ELECTRICAL PARAMETERS

Phase/Tension/Frequency		3P/380-400V/50-60Hz/N						
Cooling	Rated power input	kW	18.85	20.51	22.16	23.88	25.53	27.46
	Power input max.	kW	31.64	33.81	39.59	39.00	44.78	47.87
	Rated current	A	31.12	33.88	36.60	39.43	42.16	45.35
	Current max.	A	53.5	56.80	65.20	64.55	72.95	77.90
Heating	Rated power input	kW	19.44	21.43	22.76	24.66	26.00	28.00
	Power input max.	kW	29.28	31.20	32.80	38.28	39.88	42.39
	Rated current	A	32.10	35.39	37.59	40.73	42.94	46.24
	Current max.	A	47.3	50.40	53.08	63.00	65.68	69.88
EER			3.90	3.90	3.84	3.79	3.74	3.68
COP			4.24	4.20	4.17	4.12	4.10	4.04

PERFORMANCE

Airflow		m³/h	30000	30000	30600	31200	31480	31480
Airflow	Heating	m³/h	30000	30000	30600	31200	31480	31480
	Cooling	m³/h	26400	26400	27600	28200	29400	29400
Sound pressure level to 1 m		dB(A)	62	62.5	63	64	64.5	64.5
Sound power level		dB(A)	79	80	80	81	82	82

INSTALLATION

Dimensions (WxHxD)		mm	(1350x1690x720)x2	(1350x1690x720)x2	(1350x1690x720)x2	1350x1690x720 + 1350x2048x720	1350x1690x720 + 1350x2048x720	1350x1690x720 + 1350x2048x720
Refrigerant/GWP			R410A/2088					
Refrigerant charge		kg	10+10	10+10	10+10	10+10	10+10	10+10
Net weight/Gross weight		kg	276/301 + 279/304	279/304 + 279/304	279/304 + 321/346	321/346 + 335/360	321/346 + 335/360	321/346 + 335/360
Compressor type			Scroll	Scroll	Scroll	Scroll	Scroll	Scroll
Tubing	Liquid pipe diameter	inches	3/4"	3/4"	3/4"	3/4"	3/4"	3/4"
	Suction pipe diameter	inches	1"1/4	1"1/4	1"1/4	1"1/4	1"1/4	1"1/4
	Oil equalization pipe	inches	3/8"	3/8"	3/8"	3/8"	3/8"	3/8"
	Max. tube length	m	1000	1000	1000	1000	1000	1000
Max. height between indoor and outdoor units (ODU up/down)		m	50/40	50/40	50/40	50/40	50/40	50/40
Max. height between indoor units		m	18	18	18	18	18	18
External static pressure		Pa	82	82	82	82	82	82
Environment temperature range	Cooling	°C	-5°/50°					
	Heating	°C	-23°/21°					
Maximum indoor units connectable		quantity	53	58	62	64	64	64

TECHNICAL DATA FOR TWO COMBINATIONS

Outdoor unit			Drop only		Drop only	
	YDV1064-H13	YDV1120-H13	YDV1175-H13	YDV1240-H13	YDV1295-H13	YDV1360-H13
Phase	Three phase	Three phase	Three phase	Three phase	Three phase	Three phase
Combinations part number	YDV504 / 7SP14H034	YDV560 / 7SP14H035	YDV560 / 7SP14H035	YDV560 / 7SP14H035	YDV615 / 7SP14H036	YDV680 / 7SP14H037
	YDV560 / 7SP14H035	YDV560 / 7SP14H035	YDV615 / 7SP14H036	YDV680 / 7SP14H037	YDV680 / 7SP14H037	YDV680 / 7SP14H037



POWERS

	HP	38	40	42	44	46	48
Capacity range							
Cooling	kW	106.4	112	117.5	124	129.5	136
Heating	kW	119.5	126	132	136	142	146

ELECTRICAL PARAMETERS

Phase/Tension/Frequency		3P/380-400V/50-60Hz/N						
Cooling	Rated power input	kW	29.18	31.11	33.13	35.27	37.28	39.42
	Power input max.	kW	47.28	50.37	55.75	62.66	68.03	74.94
	Rated current	A	48.19	51.38	54.71	58.24	61.57	65.10
	Current max.	A	77.25	82.20	90.75	101.55	110.1	120.90
Heating	Rated power input	kW	29.90	31.90	34.11	35.42	37.62	38.93
	Power input max.	kW	47.87	50.37	52.91	53.81	56.34	57.24
	Rated current	A	49.38	52.68	56.33	58.49	62.14	64.30
	Current max.	A	19.80	84.00	88.05	89.40	93.45	94.80
EER			3.65	3.60	3.55	3.52	3.47	3.45
COP			4.00	3.95	3.87	3.84	3.77	3.75

PERFORMANCE



Airflow	Heating	m³/h	32400	32400	32400	32400	32400	32400
	Cooling	m³/h	30000	30000	30000	30000	30000	30000
Sound pressure level to 1 m		dB(A)	65	65	65	65.5	65.5	66
Sound power level		dB(A)	83	83	83	83	83	84

INSTALLATION

Dimensions (WxHxD)	mm	(1350x2048x720) x2	(1350x2048x720) x2	(1350x2048x720) x2	(1350x2048x720) x2	(1350x2048x720) x2	(1350x2048x720) x2	
Refrigerant/GWP		R410A/2088						
Refrigerant charge	kg	10+10	10+10	10+10	10+10	10+10	10+10	
Net weight/Gross weight	kg	(335/360)x2	(335/360)x2	335/360 + 359/384	335/360 + 359/384	(359/384)x2	359/384 + 359/384	
Compressor type		Scroll	Scroll	Scroll	Scroll	Scroll	Scroll	
Tubing	Liquid pipe diameter	inches	3/4"	3/4"	3/4"	3/4"	3/4"	
	Suction pipe diameter	inches	1"1/4	1"1/4	1"1/4	1"1/4	1"1/4	
	Oil equalization pipe	inches	3/8"	3/8"	3/8"	3/8"	3/8"	
	Max. tube length	m	1000	1000	1000	1000	1000	
Max. height between indoor and outdoor units.(ODU up/down)	m	50/40	50/40	50/40	50/40	50/40	50/40	
Max. height between indoor units	m	18	18	18	18	18	18	
External static pressure	Pa	82	82	82	82	82	82	
Environment temperature range	Cooling	°C	-5°/50°					
	Heating	°C	-23°/21°					
Maximum indoor units connectable	quantity	64	64	64	64	64	64	



TECHNICAL DATA FOR THREE COMBINATIONS

Outdoor unit	YDV1408-H13	YDV1460-H13	YDV1514-H13	YDV1570-H13
Phase	Three phase	Three phase	Three phase	Three phase
Combinations part number	YDV400 / 7SP14H032	YDV450 / 7SP14H033	YDV450 / 7SP14H033	YDV450 / 7SP14H033
	YDV504 / 7SP14H034	YDV450 / 7SP14H033	YDV504 / 7SP14H034	YDV560 / 7SP14H035
	YDV504 / 7SP14H034	YDV560 / 7SP14H035	YDV560 / 7SP14H035	YDV560 / 7SP14H035
				

POWERS

	HP	50	52	54	56
Capacity range					
Cooling	kW	140.8	146	151.4	157
Heating	kW	158	163	169.5	176

ELECTRICAL PARAMETERS

Phase/Tension/Frequency		3P/380-400V/50-60Hz/N				
Cooling	Rated power input	kW	37.50	39.37	41.08	43.02
	Power input max.	kW	61.10	70.55	69.96	73.05
	Rated current	A	61.93	65.01	67.85	71.04
	Current max.	A	100.70	114.70	114.05	119.00
Heating	Rated power input	kW	38.62	40.05	41.95	43.95
	Power input max.	kW	60.96	59.59	65.07	67.57
	Rated current	A	63.77	66.14	69.28	72.58
	Current max.	A	100.80	97.76	107.68	111.88
EER			3.75	3.71	3.69	3.65
COP			4.09	4.07	4.04	4.00

PERFORMANCE

Airflow	Heating	m³/h	44440	44440	48000	48000
	Cooling	m³/h	43200	43480	44440	44440
Sound pressure level to 1 m		dB(A)	66	66	66.5	66.5
Sound power level		dB(A)	84	84	85	85

INSTALLATION

Dimensions (WxHxD)	mm	1350x1690x720 + (1350x2048x720)x2	1350x1690x720 + (1350x2048x720)x2	1350x1690x720 + (1350x2048x720)x2	1350x1690x720 + (1350x2048x720)x2	
Refrigerant/GWP		R410A/2088				
Refrigerant charge	kg	10+10+10	10+10+10	10+10+10	10+10+10	
Net weight/Gross weight	kg	279/304 + (335/360)x2	321/346 + (335/360)x2	321/346 + (335/360)x2	(335/360)x3	
Compressor type		Scroll	Scroll	Scroll	Scroll	
Tubing	Liquid pipe diameter	inches	3/4"	3/4"	3/4"	3/4"
	Suction pipe diameter	inches	1"1/2	1"1/2	1"1/2	1"5/8
	Oil equalization pipe	inches	3/8"	3/8"	3/8"	3/8"
	Max. tube length	m	1000	1000	1000	1000
Max. height between indoor and outdoor units (ODU up/down)	m	50/40	50/40	50/40	50/40	
Max. height between indoor units	m	18	18	18	18	
External static pressure	Pa	82	82	82	82	
Environment temperature range	Cooling	°C	-5°/50°			
	Heating	°C	-23°/21°			
Maximum indoor units connectable	quantity	64	64	64	64	



TECHNICAL DATA FOR THREE COMBINATIONS

Outdoor unit	Drop only			
	YDV1624-H13	YDV1680-H13	YDV1735-H13	YDV1800-H13
Phase	Three phase	Three phase	Three phase	Three phase
Combinations part number	YDV504 / 7SP14H034	YDV560 / 7SP14H035	YDV560 / 7SP14H035	YDV560 / 7SP14H035
	YDV560 / 7SP14H035	YDV560 / 7SP14H035	YDV560 / 7SP14H035	YDV560 / 7SP14H035
	YDV560 / 7SP14H035	YDV560 / 7SP14H035	YDV615 / 7SP14H036	YDV680 / 7SP14H037



POWERS

	HP	58	60	62	64
Capacity range					
Cooling	kW	162.4	168	173,5	180
Heating	kW	182.5	189	195	199

ELECTRICAL PARAMETERS

Phase/Tension/Frequency		3P/380-400V/50-60Hz/N				
Cooling	Rated power input	kW	44.73	46.67	48,68	50.82
	Power input max.	kW	72.47	75.56	80,93	87.84
	Rated current	A	73.88	77.07	80,40	83.93
	Current max.	A	118.35	123.30	131,85	142.65
Heating	Rated power input	kW	45.85	47.85	50,06	51.37
	Power input max.	kW	73.05	75.56	78,09	78.99
	Rated current	A	75.72	79.02	82,67	84.83
	Current max.	A	121.80	126.00	130,05	131.40
EER			3.63	3.60	3,56	3.54
COP			3.98	3.95	3,90	3.87

PERFORMANCE

Airflow	Heating	m³/h	48600	48600	48600	48600
	Cooling	m³/h	45000	45000	45000	45000
Sound pressure level to 1 m		dB(A)	67	67	67	67
Sound power level		dB(A)	85	85	85	85

INSTALLATION

Dimensions (WxHxD)	mm	(1350x2048x720) x 3	(1350x2048x720) x 3	(1350x2048x720) x 2 + (1350x2048x720)	(1350x2048x720) x 3	
Refrigerant/GWP		R410A/2088				
Refrigerant charge	kg	10+10+10	10+10+10	10+10+10	10+10+10	
Net weight/Gross weight	kg	(335/360)x3	(335/360)x3	(335/360)x2 + (359/384)	(335/360)x2 + 359/384	
Compressor type		Scroll	Scroll	Scroll	Scroll	
Tubing	Liquid pipe diameter	inches	3/4"	3/4"	3/4"	3/4"
	Suction pipe diameter	inches	1"5/8	1"5/8	1"5/8	1"5/8
	Oil equalization pipe	inches	3/8"	3/8"	3/8"	3/8"
	Max. tube length	m	1000	1000	1000	1000
Max. height between indoor and outdoor units. (ODU up/down)	m	50/40	50/40	50/40	50/40	
Max. height between indoor units	m	18	18	18	18	
External static pressure	Pa	82	82	82	82	
Environment temperature range	Cooling	°C	-5°/50°			
	Heating	°C	-23°/21°			
Maximum indoor units connectable	quantity	64	64	64	64	



TECHNICAL DATA FOR THREE COMBINATIONS

Outdoor unit	Drop only		Drop only	
	YDV1855-H13	YDV1920-H13	YDV1975-H13	YDV2040-H13
Phase	Three phase	Three phase	Three phase	Three phase
Combinations part number	YDV560 / 7SP14H035	YDV560 / 7SP14H035	YDV615 / 7SP14H036	YDV680 / 7SP14H037
	YDV615 / 7SP14H036	YDV680 / 7SP14H037	YDV680 / 7SP14H037	YDV680 / 7SP14H037
	YDV680 / 7SP14H037	YDV680 / 7SP14H037	YDV680 / 7SP14H037	YDV680 / 7SP14H037



POWERS

	HP	66	68	70	72
Capacity range					
Cooling	kW	185.5	192	197.5	204
Heating	kW	205	209	215	219

ELECTRICAL PARAMETERS

Phase/Tension/Frequency		3P/380-400V/50-60Hz/N				
Cooling	Rated power input	kW	52.84	54.98	56.99	59.13
	Power input max.	kW	93.22	100.13	105.50	112.41
	Rated current	A	87.26	90.79	94.12	97.65
	Current max.	A	151.2	162.00	170.55	181.35
Heating	Rated power input	kW	53.57	54.88	57.09	58.40
	Power input max.	kW	81.53	82.43	84.96	85.86
	Rated current	A	88.48	90.64	94.29	96.45
	Current max.	A	135.45	136.80	140.85	142.20
EER			3.51	3.49	3.47	3.45
COP			3.83	3.81	3.77	3.75

PERFORMANCE

Airflow	Heating	m³/h	48600	48600	48600	48600
	Cooling	m³/h	45000	45000	45000	45000
Sound pressure level to 1 m		dB(A)	67	67.5	67.5	67.5
Sound power level		dB(A)	85	86	86	86

INSTALLATION

Dimensions (WxHxD)	mm	(1350x2048x720) x 3	(1350x2048x720) x 3	(1350x2048x720) x 3	(1350x2048x720) x 3	
Refrigerant/GWP		R410A/2088				
Refrigerant charge	kg	10+10+10	10+10+10	10+10+10	10+10+10	
Net weight/Gross weight	kg	(335/360)x2 + 359/384	335/360 + (359/384)x2	335/360 + (359/384)x2	335/360 + (359/384)x2	
Compressor type		Scroll	Scroll	Scroll	Scroll	
Tubing	Liquid pipe diameter	inches	7/8"	7/8"	7/8"	7/8"
	Suction pipe diameter	inches	1"3/4	1"3/4	1"3/4	1"3/4
	Oil equalization pipe	inches	3/8"	3/8"	3/8"	3/8"
	Max. tube length	m	1000	1000	1000	1000
Max. height between indoor and outdoor units (ODU up/down)	m	50/40	50/40	50/40	50/40	
Max. height between indoor units	m	18	18	18	18	
External static pressure	Pa	82	82	82	82	
Environment temperature range	Cooling	°C	-5°/50°			
	Heating	°C	-23°/21°			
Maximum indoor units connectable	quantity	64	64	64	64	



+ PRODUCTS

- Heat recovery.
- COP can reach 4.10.
- Wide capacity range.
- Silent mode: -8 dB(A).



RWW06
(optional)



RWW08
(optional)

FEATURES

TECHNOLOGY:



R410A FLUID



DC INVERTER



- Simultaneous operation in heating and cooling mode.
- Capacity range from 10 to 48 HP.
- Up to 64 indoor connectable units.
- DC inverter fan.
- Capacity ratio 50-130%.
- Minimum outdoor temperature for heating operation -15°C.
- Minimum outdoor temperature for cooling operation -5°C.
- Same indoor units and control devices across Mini FlowLogic II and FlowLogic III ranges (except EAV console range).
- Optimized dimensions, can be transported by elevator.
- Operation with time equalization (for twinned groups).
- Wide range of control systems.

3-PIPES VRF RANGE SPECIFIC ACCESSORIES

Accessory	Part number	Photo	Description
TAS 20 HR	7ACFHH011		Gather pipe kit for 3 outdoor groups
TAS 30 HR	7ACFHH012		Gather pipe kit for 3 outdoor groups
TAU 335 HR	7ACFHH007		Manifold pipe for capacity less than 33.5 kW
TAU 506 HR	7ACFHH008		Manifold pipe for capacity less than 50.6 kW
TAU 730 HR	7ACFHH009		Manifold pipe for capacity less than 73.0 kW
TAU 1350 HR	7ACFHH010		Manifold pipe for capacity less than 135.0 kW
Valve box	7ACELH017		kit HR under 11.2 kW
Valve box	7ACELH018		Kit HR 11.2 kW - 18 kW
Valve box	7ACELH019		Kit HR above 18 kW

See general accessories on page 44.

OPERATION PRINCIPLE OF THE HEAT RECOVERY SYSTEM

- Simultaneous operation in hot and cold.
- Overall optimization of the efficiency of the system by heat transfer between the rooms to be heated and cooled.
- Reactive during a change of operating mode (heating/cooling).

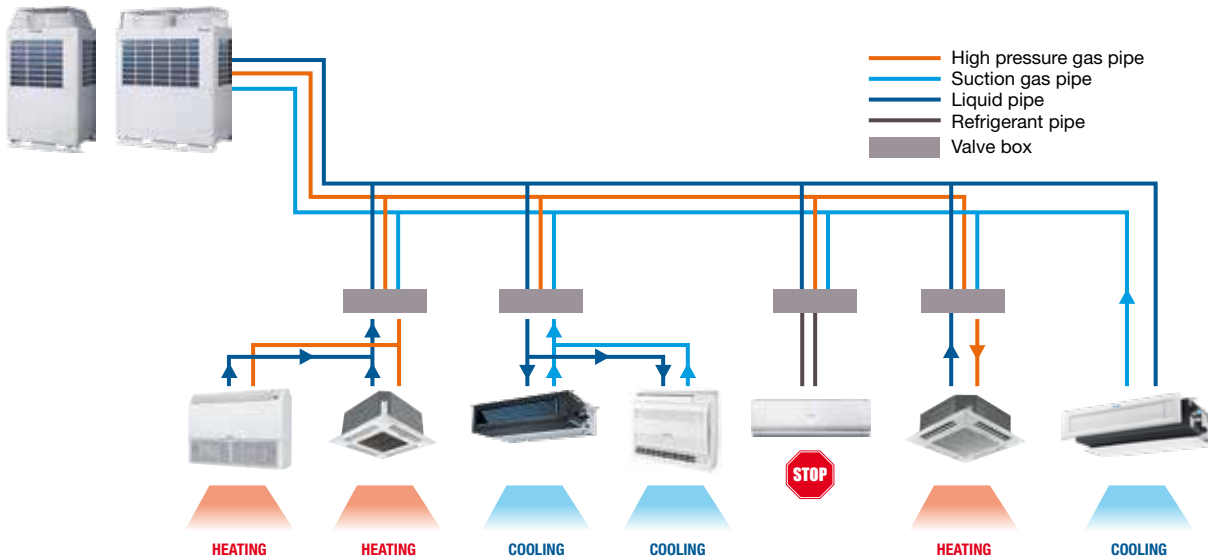

HIGH PERFORMANCE

- Optimized operation at partial load: two-part condenser with independent control (double electronic expander).
- DC Inverter compressor (1 additional fixed speed compressor from 12 HP).
- Powerful DC fan (low noise level and energy savings).
- Wide operating range.

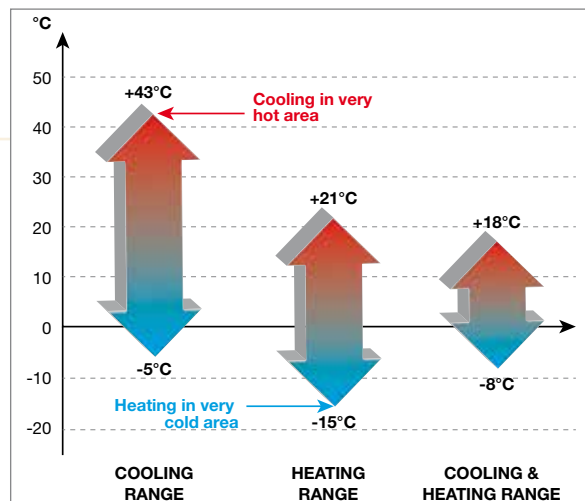

EASY INSTALLATION

- Accessible cooling network, regardless of the electronic part.
- Ducted unit: possible installation indoors (static pressure 50 Pa).

**Hidden solution:
installation of
outdoor unit in a
technical room**





RANGE TABLE FLOWLOGIC II HR

Capacity (HP)	Cooling power (kW)	Heating power (kW)	OUTDOOR UNITS	INDOOR UNITS	
			Combinations FlowLogic II HR	Maximum Indoor unit connectable	Range cooling power connectable* (kW)
10	28	31.5	1 X YCV280HR	16	14 - 36
12	33.5	37.5	1 X YCV335HR	19	17 - 43
14	40	45	1 X YCV400HR	23	20 - 52
16	45	50	1 X YCV450HR	26	22.5 - 58.5
20	56	63	2 X YCV280HR	33	28 - 72
22	61.5	69	1 X YCV280HR + 1 X YCV335HR	36	31 - 79.5
24	68	76.5	1 X YCV280HR + 1 X YCV400HR	39	34 - 88
26	73	81.5	1 X YCV280HR + 1 X YCV450HR	43	37 - 94.5
28	80	87.5	2 X YCV400HR	46	40 - 104
30	85	95	1 X YCV400HR + 1 X YCV450HR	50	43 - 110.5
32	90	100	2 X YCV450HR	53	45 - 117
34	96	108	2 X YCV280HR + 1 X YCV400HR	56	48 - 124.5
36	101	113	2 X YCV280HR + 1 X YCV450HR	59	51 - 131
38	108	119	1 X YCV280HR + 2 X YCV400HR	63	54 - 140
40	113	126.5	1 X YCV280HR + 1 X YCV400HR + 1 X YCV450HR	64	57 - 146.5
42	118	131.5	1 X YCV280HR + 2 X YCV450HR	64	59 - 153
44	123.5	137.5	1 X YCV335HR + 2 X YCV450HR	64	62 - 160.5
46	130	145	1 X YCV400HR + 2 X YCV450HR	64	65 - 169
48	135	150	3 X YCV450HR	64	68 - 175.5

* Indoor total capacity can be 50% - 130% of outdoor capacity.

FLOWLOGIC II HR TECHNICAL DATA

Outdoor unit		AWAU-YCV280HR-H13	AWAU-YCV335HR-H13	AWAU-YCV400HR-H13	AWAU-YCV450HR-H13
Phase		Three phase	Three phase	Three phase	Three phase
Part number		7SP14H016	7SP14H019	7SP14H017	7SP14H018
					
RATED POWER					
Cooling	kW	28	33.5	40	45
Heating	kW	31.5	37.5	45	50
ELECTRICAL PARAMETERS					
Phase/Tension/Frequency		3P/380-400V/50-60Hz/N			
Cooling rated power input	kW	3.71	9.18	12.3	14.1
Heating rated power input	kW	7.55	9.15	11.1	13.5
EER/COP		3.71/3.95	3.65/4.10	3.25/4.05	3.20/3.70
Max. current	A	23.4	27.9	29.5	32.37
PERFORMANCE					
Airflow (HS)	m³/h	11100	14100	14100	14100
Noise level (HS)	dB(A)	57	60	60	60
INSTALLATION					
External dimensions (WxHxD)	mm	990x1808x750	1390x1808x750	1390x1808x750	1390x1808x750
Shipping dimensions (WxHxD)	mm	1090x1990x860	1490x1990x860	1490x1990x860	1490x1990x860
Net weight/Gross weight	kg	240/268	368/393	368/393	368/393
Compressor type		Scroll DC Inverter	Scroll DC Inverter	Scroll DC Inverter	Scroll DC Inverter
Liquid pipe diameter	inches	3/8"	1/2"	1/2"	1/2"
Suction pipe diameter	inches	7/8"	1"	1"	1"1/8"
Max. pipe length	m	300	300	300	300
Max. height between indoor and outdoor units*	m	50/40	50/40	50/40	50/40
Max. height between indoor units	m	15	15	15	15
Maximum indoor units connectable	quantity	16	19	23	26
OPERATING LIMITS					
Cooling	°C	-5°/43° Dry bulb			
Heating	°C	-15°/21° Dry bulb			
PIPE LINE					
Refrigerant/GWP		R410A/2088	R410A/2088	R410A/2088	R410A/2088
Charge	kg	10	10	10	10

* 30 m if the outdoor unit is above indoor unit, 20 m if the outdoor unit is below indoor unit.

TECHNICAL DATA FOR TWO COMBINATIONS

Indoor unit	YCV560HR-H13	YCV615HR-H13	YCV680HR-H13	YCV730HR-H13
Phase	Three phase	Three phase	Three phase	Three phase
Combinations part number	YCV280HR / 7SP14H016	YCV280HR / 7SP14H016	YCV280HR / 7SP14H016	YCV280HR / 7SP14H016
	YCV280HR / 7SP14H016	YCV335HR / 7SP14H019	YCV400HR / 7SP14H017	YCV450HR / 7SP14H018
				

RATED POWER

	HP	20	22	24	26
Capacity range					
Cooling	kW	56	61.5	68	73
Heating	kW	63	69	76.5	81.5

ELECTRICAL PARAMETERS

Phase/Tension/Frequency		3P/380-400V/50-60Hz/N				
Cooling	Rated power input	kW	15.1	16.73	19.85	21.65
	EER		3.71	3.68	3.43	3.37
	Rated current	A	24.67	27.33	32.43	35.37
Heating	Rated power input	kW	15.94	17.12	19.07	21.47
	COP		3.95	4.03	4.01	3.80
	Rated current	A	26.04	27.97	31.16	35.08
Power input max.	kW	29.4	32.24	33.25	35.18	
Current max.	A	46.8	51.3	52.9	55.77	

PERFORMANCE

	m³/h	22200	25200	25200	25200
Airflow					
Sound pressure level to 1 m	dB(A)	60	61	61	61

INSTALLATION

Dimensions (WxHxD)	mm	(990x1808x750)*2	990x1808x750 + 1390x1808x750	990x1808x750 + 1390x1808x750	990x1808x750 + 1390x1808x750	
Package dimensions (WxHxD)		(1090x1990x860)*2	1090x1990x860 + 1490x1990x860	1090x1990x860 + 1490x1990x860	1090x1990x860 + 1490x1990x860	
Net weight/Gross weight	kg	480/510	608/641	608/641	608/641	
Refrigerant/GWP		R410A/2088	R410A/2088	R410A/2088	R410A/2088	
Refrigerant charge	kg	20	20	20	20	
Compressor type		Scroll	Scroll	Scroll	Scroll	
Tubing	Liquid pipe diameter	inches	5/8"	5/8"	5/8"	3/4"
	Suction pipe diameter	inches	1"1/8	1"1/8	1"1/4	1"1/4
	Max. tube length	m	300	300	300	300
Max. height between indoor and outdoor units (ODU up/down)	m	50/40	50/40	50/40	50/40	
Max. height between indoor units	m	15	15	15	15	
Environment temperature range	Cooling	°C	-5°/43° Dry bulb			
	Heating	°C	-15°/21° Dry bulb			
Maximum indoor units connectable	quantity	33	36	39	43	

TECHNICAL DATA FOR TWO COMBINATIONS

Indoor unit	YCV800HR-H13	YCV850HR-H13	YCV900HR-H13
Phase	Three phase	Three phase	Three phase
Combinations part number	YCV400HR / 7SP14H017	YCV400HR / 7SP14H017	YCV450HR / 7SP14H018
	YCV400HR / 7SP14H017	YCV450HR / 7SP14H018	YCV450HR / 7SP14H018
			

RATED POWER				
Capacity range	HP	28	30	32
Cooling	kW	80	85	90
Heating	kW	90	95	100

ELECTRICAL PARAMETERS					
Phase/Tension/Frequency			3P/380-400V/50-60Hz/N		
Cooling	Rated power input	kW	24.6	26.4	28.2
	EER		3.25	3.22	3.19
	Rated current	A	40.19	43.13	46.07
Heating	Rated power input	kW	22.2	24.6	27
	COP		4.05	3.86	3.70
	Rated current	A	36.27	40.19	44.11
Power input max.		kW	37.1	39.03	40.96
Current max.		A	59	61.87	64.74

PERFORMANCE				
Airflow	m³/h	28200	28200	28200
Sound pressure level to 1 m	dB(A)	62	62	62

INSTALLATION					
Dimensions (WxHxD)		mm	1390x1808x750+1390x1808x750	1390x1808x750+1390x1808x750	(1390x1808x750)*2
Package dimensions (WxHxD)			1490x1990x860+1490x1990x860	1490x1990x860+1490x1990x860	(1490x1990x860)*2
Net weight/Gross weight		kg	736/772	736/772	736/772
Refrigerant/GWP			R410A/2088	R410A/2088	R410A/2088
Refrigerant charge		kg	20	20	20
Compressor type			Scroll	Scroll	Scroll
Tubing	Liquid pipe diameter	inches	3/4"	3/4"	3/4"
	Suction pipe diameter	inches	1"1/4	1"1/4	1"1/4
	Max. tube length	m	300	300	300
Max. height between indoor and outdoor units (ODU up/down)		m	50/40	50/40	50/40
Max. height between indoor units		m	15	15	15
Environment temperature range	Cooling	°C	-5°/43° Dry bulb		
	Heating	°C	-15°/21° Dry bulb		
Maximum indoor units connectable		quantity	46	50	53

TECHNICAL DATA FOR THREE COMBINATIONS

Indoor unit	YCV960HR-H13	YCV1010HR-H13	YCV1080HR-H13	YCV1180HR-H13
Phase	Three phase	Three phase	Three phase	Three phase
Combinations part number	YCV280HR / 7SP14H016	YCV280HR / 7SP14H016	YCV280HR / 7SP14H016	YCV280HR / 7SP14H016
	YCV280HR / 7SP14H016	YCV280HR / 7SP14H016	YCV400HR / 7SP14H017	YCV400HR / 7SP14H017
	YCV400HR / 7SP14H017	YCV450HR / 7SP14H018	YCV400HR / 7SP14H017	YCV450HR / 7SP14H018
				

RATED POWER

	HP	34	36	38	40
Capacity range					
Cooling	kW	96	101	108	113
Heating	kW	108	113	121.50	126.5

ELECTRICAL PARAMETERS

Phase/Tension/Frequency		3P/380-400V/50-60Hz/N				
Cooling	Rated power input	kW	27.4	29.2	32.15	33.95
	EER		3.50	3.46	3.36	3.33
	Rated current	A	44.76	47.71	52.53	55.47
Heating	Rated power input	kW	27.04	29.44	30.17	32.57
	COP		3.99	3.84	4.03	3.88
	Rated current	A	44.18	48.10	49.29	53.21
Power input max.	kW	47.95	49.88	51.8	53.73	
Current max.	A	76.3	79.17	82.4	85.27	



PERFORMANCE

Airflow	m ³ /h	39300	36300	39300	39300
Sound pressure level to 1 m	dB(A)	63	63	63	63

INSTALLATION

Dimensions (WxHxD)	mm	990x1808x750*2 + 1390x1808x750	(990x1808x750)*2 + (1390x1808x750)	990x1808x750 + 1390x1808x750 + 1390x1808x750	(990x1808x750) + (1390x1808x750) + (1390x1808x750)
Package dimensions (WxHxD)		1090x1990x860*2 + 1490x1990x860	(1090x1990x860)*2 + (1490x1990x860)	1090x1990x860 + 1490x1990x860 + 1490x1990x860	(1090x1990x860) + (1490x1990x860) + (1490x1990x860)
Net weight/Gross weight	kg	848/896	848/896	976/1027	976/1027
Refrigerant/GWP		R410A/2088	R410A/2088	R410A/2088	R410A/2088
Refrigerant charge	kg	30	30	30	30
Compressor type		Scroll	Scroll	Scroll	Scroll
Tubing	Liquid pipe diameter	inches	3/4"	3/4"	3/4"
	Suction pipe diameter	inches	1"1/4	1"1/4	1"1/4
	Max. tube length	m	300	300	300
Max. height between indoor and outdoor units (ODU up/down)	m	50/40	50/40	50/40	50/40
Max. height between indoor units	m	15	15	15	15
Environment temperature range	Cooling	°C	-5°/43° Dry bulb		
	Heating	°C	-15°/21° Dry bulb		
Maximum indoor units connectable	quantity	56	59	63	64

TECHNICAL DATA FOR THREE COMBINATIONS

Indoor unit		YCV1180HR-H13	YCV1235HR-H13	YCV1300HR-H13	YCV1350HR-H13	
Phase		Three phase	Three phase	Three phase	Three phase	
Combinations part number		YCV280HR / 7SP14H016	YCV335HR / 7SP14H019	YCV400HR / 7SP14H017	YCV450HR / 7SP14H018	
		YCV450HR / 7SP14H018	YCV450HR / 7SP14H018	YCV450HR / 7SP14H018	YCV450HR / 7SP14H018	
		YCV450HR / 7SP14H018	YCV450HR / 7SP14H018	YCV450HR / 7SP14H018	YCV450HR / 7SP14H018	
						
RATED POWER						
Capacity range	HP	42	44	46	48	
Cooling	kW	118	123.5	130	135	
Heating	kW	131.5	137.5	145	150	
ELECTRICAL PARAMETERS						
Phase/Tension/Frequency		3P/380-400V/50-60Hz/N				
Cooling	Rated power input	kW	35.75	37.38	40.5	42.3
	EER		3.30	3.30	3.21	3.19
	Rated current	A	58.41	61.07	66.17	69.11
Heating	Rated power input	kW	34.97	36.15	38.1	40.5
	COP		3.76	3.80	3.81	3.70
	Rated current	A	57.13	59.06	62.25	66.17
Power input max.		kW	55.66	58.5	59.51	61.44
Current max.		A	88.14	92.64	94.24	97.11
PERFORMANCE						
Airflow		m³/h	39300	42300	42300	42300
Sound pressure level to 1 m		dB(A)	63	64	64	64
INSTALLATION						
Dimensions (WxHxD)		mm	(990x1808x750) + (1390x1808x750)*2	(1390x1808x750) + (1390x1808x750)*2	(1390x1808x750) + (1390x1808x750)*2	(1390x1808x750)*3
Package dimensions (WxHxD)			(1090x1990x860) + (1490x1990x860)*2	(1490x1990x860) + (1490x1990x860)*2	(1490x1990x860) + (1490x1990x860)*2	(1490x1990x860)*3
Net weight/Gross weight		kg	976/1027	1104/1158	1104/1158	1104/1158
Refrigerant/GWP			R410A/2088	R410A/2088	R410A/2088	R410A/2088
Refrigerant charge		kg	30	30	30	30
Compressor type			Scroll	Scroll	Scroll	Scroll
Tubing	Liquid pipe diameter	inches	3/4"	3/4"	3/4"	3/4"
	Suction pipe diameter	inches	1"1/4	1"1/4	1"1/4	1"1/4
	Max. tube length	m	300	300	300	300
Max. height between indoor and outdoor units (ODU up/down)		m	50/40	50/40	50/40	50/40
Max. height between indoor units		m	15	15	15	15
Environment temperature range	Cooling	°C	-5°/43° Dry bulb			
	Heating	°C	-15°/21° Dry bulb			
Maximum indoor units connectable		quantity	64	64	64	64



+ PRODUCTS

- COP can reach 6.02.
- Compact design.
- Quiet solution.
- Double coil heat exchanger.

FEATURES

TECHNOLOGY:



R410A FLUID



DC INVERTER



- Capacity range from 8 to 36 HP.
- Designed for all commercial uses.
- Inlet water temperature range: from 7 to 45°C.
- Stacked installation.
- Constant EER and COP: no influence from outdoor temperature.
- DC Inverter compressor.

WATER FLOWLOGIC TECHNICAL DATA

		Drop only	Drop only	Drop only	
Outdoor unit		YWC220-H13	YWC280-H13	YWC335-H13	
Part number		7SP14H038	7SP14H039	7SP14H040	
POWERS					
Capacity range	HP	8	10	12	
Cooling capacity	kW	22.4	28	33.5	
Heating capacity	kW	25	31.5	37.5	
ELECTRICAL PARAMETERS					
Phase/Tension/Frequency		3P/380-400V/50-60Hz	3P/380-400V/50-60Hz	3P/380-400V/50-60Hz	
Cooling	Rated power input	kW	4.50	6.00	7.70
	Max. power input	kW	13.00	15.00	17.00
	Rated current	A	7.20	9.60	12.32
	Max.current	A	20.79	23.99	27.19
Heating	Rated power input	kW	4.15	5.80	7.80
	Max. power input	kW	13.00	15.00	17.00
	Rated current	A	6.64	9.28	12.47
	Max.current	A	20.79	23.99	27.19
EER/COP			4.98/6.02	4.67/5.43	4.35/4.81
PERFORMANCE					
Water flow (HS)	m³/h	4.8	6	7.2	
Sound pressure level (HS)	dB(A)	50	51	53	
Sound power level (HS)	dB(A)	61	62	64	
INSTALLATION					
External dimensions (WxDxH)	mm	775x545x995	775x545x995	775x545x995	
Shipping dimensions (WxDxH)	mm	875x655x1182	875x655x1182	875x655x1182	
Net/Shipping weight	kg	172/183	172/183	172/183	
Compressor type		Scroll DC Inverter	Scroll DC Inverter	Scroll DC Inverter	
Refrigerant/GWP		R410A/2088	R410A/2088	R410A/2088	
Refrigerant charge	kg	2	2	2	
Refrigerant liquid pipe	mm	3/8"	3/8"	1/2"	
Refrigerant gas pipe	mm	3/4"	7/8"	1"	
Oil equalization pipe	mm	3/8"	3/8"	3/8"	
Total pipe length	m	300	300	300	
Max. pipe length (equivalent/actual)	m	150/120	150/120	150/120	
Max. height between indoor and outdoor units (ODU up/down)	m	50/40	50/40	50/40	
WATER SIDE					
Inlet water connection pipe	mm	DN32	DN32	DN32	
Outlet water connection pipe	mm	DN32	DN32	DN32	
Pressure drop (inlet and outlet)	Kpa	35	50	70	
Connection type		inner grooved	inner grooved	inner grooved	
Max. system water pressure	Mpa	1.6	1.6	1.6	
Inlet water temperature range (cooling/heating)	°C	7°/45°	7°/45°	7°/45°	
CONNECTION RATIO					
Connectable indoor unit ratio	%	50-130	50-130	50-130	
Maximum number of indoor units	unit	13	16	19	

* All the specifications are tested under nominal condition (in cooling, indoor temp. is 27°C DB/19°C WB; outdoor temp 35°C DB/24WB; in heating, indoor temp. is 20°C DB, in heating, outdoor temp. is 7°C DB/6°CWB).



+ PRODUCTS

- Quiet.
- 3D and long distance air supply.
- Hidden screen.
- Two sides drain.



RCV02
(included)



RWW05
(optional)



RWW03
(optional)



RWW07
(optional)

FEATURES

TECHNOLOGY:



R410A FLUID



ELECTRONIC EXPANSION VALVE

- EEV inside: for an easier installation.
- High-quality DC fan motor: reduce the indoor unit noise greatly.
- Fashion design.
- Infrared remote controller included.

HBV TECHNICAL DATA

Indoor unit	Drop only				Drop only			
	AWSI-HBV007-N11	AWSI-HBV009-N11	AWSI-HBV012-N11	AWSI-HBV016-N11	AWSI-HBV018-N11	AWSI-HBV024-N11	AWSI-HBV030-N11	
Phase	Single phase	Single phase	Single phase	Single phase	Single phase	Single phase	Single phase	
Part number	7SP02H012	7SP02H013	7SP02H014	7SP02H017	7SP02H015	7SP02H016	7SP02H018	
RATED POWER								
Cooling	kBtu/h	7.5	9.5	12.3	15.3	19.1	24.2	30.7
	kW	2.2	2.8	3.6	4.5	5.6	7.1	9
Heating	kBtu/h	8.5	10.9	13.6	17.1	21.5	27.3	34.1
	kW	2.5	3.2	4	5	6.3	8	10
ELECTRICAL PARAMETERS								
Phase/Tension/Frequency	1P/220-230V/50Hz							
PERFORMANCE								
Airflow	m ³ /h	600	600	600	800/720/650	800	1000	1600/1500/1400
Noise level (LS/MS/HS)	dB(A)	29/31/35	29/31/36	29/33/37	39/36/34	35/39/40	36/40/44	49/44/41
INSTALLATION								
External dimensions (WxHxD)	mm	855x280x200	855x280x200	855x280x200	1115x336x243	1115x336x243	1115x336x243	1115x336x243
Shipping dimensions (WxHxD)	mm	954x355x279	954x355x279	954x355x279	1206x418x342	1206x418x342	1206x418x342	1206x418x342
Net weight/Gross weight	kg	10.9/12.6	10.9/12.6	10.9/12.6	13/16.5	13/16.5	13/16.5	13/16.5
Liquid pipe diameter	inches	1/4"	1/4"	1/4"	1/4"	1/4"	3/8"	3/8"
Suction pipe diameter	inches	3/8"	3/8"	1/2"	1/2"	1/2"	5/8"	5/8"

Dimensions: 007-009-012 models

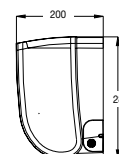
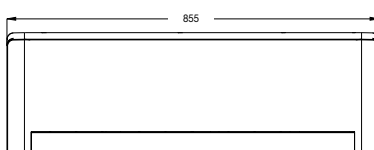

Dimensions: 018-024-030 models

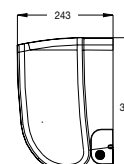
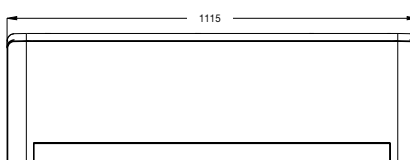



- Easy installation in false ceiling.
- Super quiet due to special fan design.
- Built-in high head pump (height up to 600 mm).
- Possible connection to a ventilation network due to a fresh air inlet (10-15% max).
- Dry contact: hotel/bungalow solutions (room card or on/off contact).

CBV TECHNICAL DATA

Indoor unit		AWSI-CBV005-N11	AWSI-CBV007-N11	AWSI-CBV009-N11	AWSI-CBV012-N11	AWSI-CBV016-N11
Phase		Single phase	Single phase	Single phase	Single phase	Single phase
Part number		7SP04H020	7SP04H000	7SP04H001	7SP04H002	7SP04H003
RATED POWER						
Cooling	kBtu/h	5.1	7.5	9.5	12.3	15.3
	kW	1.5	2.2	2.8	3.6	4.5
Heating	kBtu/h	5.8	8.5	10.9	13.6	17.1
	kW	1.7	2.5	3.2	4	5
ELECTRICAL PARAMETERS						
Phase/Tension/Frequency		1P/220-230V/50Hz				
PERFORMANCE						
Airflow	m ³ /h	650	700	700	700	700
Noise level (LS/MS/HS)	dB(A)	28/29/31	29/30/32	29/30/32	29/30/32	29/30/33
INSTALLATION						
External dimensions (WxHxD)	mm	570x570x260	570x570x260	570x570x260	570x570x260	570x570x260
Shipping dimensions (WxHxD)	mm	718x680x380	718x680x380	718x680x380	718x680x380	718x680x380
Net weight/Gross weight	kg	17/21	17/21	19/21	19/21	19/21
Liquid pipe diameter	inches	1/4"	1/4"	1/4"	1/4"	1/4"
Suction pipe diameter	inches	3/8"	3/8"	3/8"	1/2"	1/2"
FRAME						
Frame part number		7ACVFH001	7ACVFH001	7ACVFH001	7ACVFH001	7ACVFH001
External dimensions (WxHxD)	mm	700x700x60	700x700x60	700x700x60	700x700x60	700x700x60
Shipping dimensions (WxHxD)	mm	740x750x115	740x750x115	740x750x115	740x750x115	740x750x115
Net weight/Gross weight	kg	2.8/4.5	2.8/4.5	2.8/4.8	2.8/4.8	2.8/4.8

Dimensions:

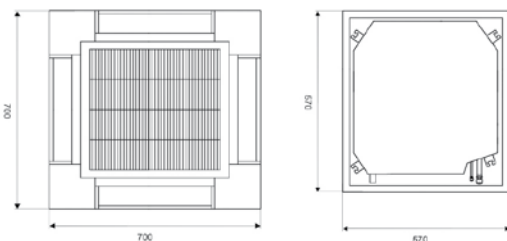

+ PRODUCTS

- Quiet operation.
- Built-in high head drain pump.
- Fresh air inlet.
- Wired controller RWW05 included.
- EEV inside.
- Automatic swing.



RWW05 (included)



RCV02 (optional)



RWW03 (optional)



RWW07 (optional)

FEATURES

TECHNOLOGY:





+ PRODUCTS

- Compact design.
- Advance structure facilitating cleaning and installation.
- Fresh air inlet.
- EEV inside.
- Wired controller RWW05 included.
- Automatic swing.
- IR receipt included.



RWW05
(included)



RCV02
(optional)



RWW03
(optional)



RWW07
(optional)

FEATURES

TECHNOLOGY:



- Easy installation in false ceiling.
- Possible connection to a ventilation network due to a fresh air inlet (10-15% max).
- Built-in high head pump (height up to 600 mm).
- Better comfort due to its high airflow.
- Dry contact: hotel/bungalow solutions (room card or on/off contact).

CCV TECHNICAL DATA

Indoor unit		AWSI- CCV018-N11	AWSI- CCV024-N11	AWSI- CCV030-N11	AWSI- CCV048-N11
Phase		Single phase	Single phase	Single phase	Single phase
Part number		7SP04H004	7SP04H005	7SP04H007	7SP04H009
RATED POWER					
Cooling	kBtu/h	19.1	24.2	30.7	47.7
	kW	5.6	7.1	9	14
Heating	kBtu/h	21.5	27.3	34.1	54.6
	kW	6.3	8	10	16
ELECTRICAL PARAMETERS					
Phase/Tension/Frequency		1P/220-230V/50Hz			
PERFORMANCE					
Airflow	m ³ /h	1200	1200	1800	1800
Noise level (LS/MS/HS)	dB(A)	30/32/34	31/35/34	31/35/37	35/39/42
INSTALLATION					
External dimensions (WxHxD)	mm	840x840x240	840x840x240	840x840x295	840x840x295
Shipping dimensions (WxHxD)	mm	930x930x330	930x930x330	930x930x390	930x930x390
Net weight/Gross weight	kg	30/36	30/36	38/40	38/40
Liquid pipe diameter	inches	1/4"	3/8"	3/8"	3/8"
Suction pipe diameter	inches	1/2"	5/8"	5/8"	5/8"
FRAME					
Frame part number		7ACVFH002	7ACVFH002	7ACVFH002	7ACVFH002
External dimensions (WxHxD)	mm	950x950x80	950x950x80	950x950x80	950x950x80
Shipping dimensions (WxHxD)	mm	985x985x115	985x985x115	985x985x115	985x985x115
Net weight/Gross weight	kg	6/9	6/9	6/9	6/9

Be replaced by new CFV model.

Dimensions: 018-024-030-048 models

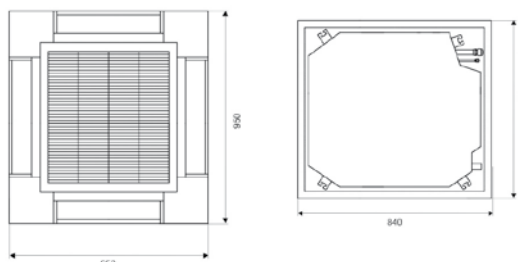

CFV

360° CASSETTE



- Ideal for slim false ceiling.
- Round way airflow.
- Possible connection to a ventilation network due to a fresh air inlet (10-15% max).
- Built-in high head pump (height up to 600 mm).
- Better comfort due to its high airflow.
- Dry contact: hotel/bungalow solutions (room card or on/off contact).

CFV TECHNICAL DATA						Drop only
Indoor unit		AWSI-CFV018-N11	AWSI-CFV024-N11	AWSI-CFV030-N11	AWSI-CFV048-N11	AWSI-CFV060-N11
Phase		Single phase	Single phase	Single phase	Single phase	Single phase
Part number		7SP04H028	7SP04H029	7SP04H030	7SP04H032	7SP04H010
RATED POWER						
Cooling	kBtu/h	19.1	24.2	30.7	47.7	54.6
	kW	5.6	7.1	9	14	16
Heating	kBtu/h	21.5	27.3	34.1	54.6	61.2
	kW	6.3	8	10	16	18
ELECTRICAL PARAMETERS						
Phase/Tension/Frequency		1P/220-230V/50Hz				
PERFORMANCE						
Airflow (LS/MS/HS)	m³/h	620/810/1000	1000/1190/1380	1660/1670/2050	1720/1910/2100	1720/1910/2100
Noise level (LS/MS/HS)	dB(A)	29/30/33	31/34/35	31/35/37	36/40/44	36/40/44
INSTALLATION						
External dimensions (WxHxD)	mm	840x183x840	840x204x840	840x246x840	840x288x840	840x288x840
Shipping dimensions (WxHxD)	mm	983x268x983	983x290x983	983x331x983	983x373x983	983x373x983
Net weight/Gross weight	kg	28/31	29/32	34/37	35/38	35/38
Liquid pipe diameter	inches	1/4"	3/8"	3/8"	3/8"	3/8"
Suction pipe diameter	inches	1/2"	5/8"	5/8"	5/8"	5/8"
FRAME						
Frame part number		7ACVFH003	7ACVFH003	7ACVFH003	7ACVFH003	7ACVFH003
External dimensions (WxHxD)	mm	950x50x950	950x50x950	950x50x950	950x50x950	950x50x950
Shipping dimensions (WxHxD)	mm	1013x1025x123	1013x1025x123	1013x1025x123	1013x1025x123	1013x1025x123
Net weight/Gross weight	kg	6.5/9	6.5/9	6.5/9	6.5/9	6.5/9



+ PRODUCTS

- Compact design.
- Fresh air inlet.
- EEV inside.
- Wired controller RWW05 included.



RWW05 (included)



RCV02 (optional)



RWW03 (optional)



RWW07 (optional)

FEATURES

TECHNOLOGY:



R410A FLUID



ELECTRONIC EXPANSION VALVE



4D AIRFLOW



- Precise control of the airflow via wide angle louvers.
- Floor & ceiling installation.
- Long distance air throw.
- Dry contact: hotel/bungalow solutions (room card or on/off contact).

+ PRODUCTS

- Ultra-thin unit body, only thick 199 mm.
- Wide-angle airflow.
- Quiet running.
- EEV inside.
- Wired controller RWW05 included.
- Automatic swing.



RWW05
(included)



RCV02
(optional)



RWW03
(optional)



RWW07
(optional)

FEATURES

TECHNOLOGY:



R410A FLUID



ELECTRONIC EXPANSION VALVE

FAV TECHNICAL DATA

Indoor unit	Drop only				Drop only				
	AWSI-FAV009-N11	AWSI-FAV012-N11	AWSI-FAV018-N11	AWSI-FAV024-N11	AWSI-FAV028-N11	AWSI-FAV030-N11	AWSI-FAV038-N11	AWSI-FAV048-N11	
Phase	Single phase	Single phase	Single phase	Single phase	Single phase	Single phase	Single phase	Single phase	
Part number	7SP02H007	7SP02H008	7SP02H010	7SP02H011	7SP01H000	7SP01H001	7SP01H002	7SP01H003	
RATED POWER									
Cooling	kBtu/h	9.5	12.3	19.1	24.2	27.3	30.7	38.2	48
	kW	2.8	3.6	5.6	7.1	8	9	11.2	14
Heating	kBtu/h	10.9	13.6	21.5	27.3	30.7	34.1	42.6	55
	kW	3.2	4.0	6.3	8.0	9	10	12.5	16
ELECTRICAL PARAMETERS									
Phase/Tension/Frequency	1P/220-230V/50Hz								
PERFORMANCE									
Airflow (LS/MS/HS)	m³/h	580/710/800	580/710/800	580/710/800	580/710/800	1610/1820/2040	1610/1820/2040	1610/1820/2040	1610/1820/2040
Noise level (LS/MS/HS)	dB(A)	33/35/38	33/35/38	35/37/40	35/37/40	38/40/43	38/40/43	38/42/46	38/42/46
Sound pressure level (LS/MS/HS)		46/48/51	46/48/51	48/50/53	48/50/53	51/53/56	51/53/56	51/55/59	51/55/59
INSTALLATION									
External dimensions (WxHxD)	mm	990x655x199	990x665x199	990x655x199	990x665x199	1580x700x240	1580x700x240	1580x700x240	1580x700x240
Shipping dimensions (WxHxD)	mm	1160x730x280	1160x730x280	1160x730x280	1160x730x280	1720x800x330	1720x800x330	1720x800x330	1720x800x330
Net weight/Gross weight	kg	28.3/34.3	28.3/36.4	28.3/36.4	28.3/36.4	50/57	50/57	54/61	54/61
Liquid pipe diameter	inches	1/4"	1/4"	1/4"	3/8"	3/8"	3/8"	3/8"	3/8"
Suction pipe diameter	inches	3/8"	1/2"	1/2"	5/8"	5/8"	5/8"	5/8"	5/8"

Dimensions: 012 to 024 models

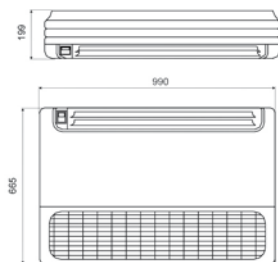

Dimensions: 28 to 48 models

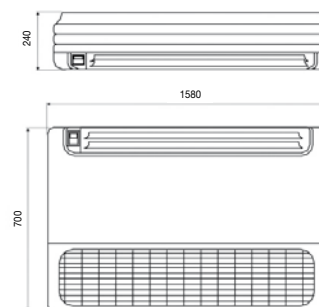



- Super slim design: 185 mm.
- Reserved fresh air inlet.
- Build-in high head drain pump.
- Friendly design of rear or bottom air return.
- Quiet operation.
- Static pressure: 0-30 Pa.

DDV TECHNICAL DATA

Indoor unit		AWSI-DDV007-N11	AWSI-DDV009-N11	AWSI-DDV012-N11	AWSI-DDV016-N11
Phase		Single phase	Single phase	Single phase	Single phase
Part number		7SP03H025	7SP03H026	7SP03H027	7SP03H028
RATED POWERS					
Cooling	kBtu/h	7.5	9.5	12.3	15.3
	kW	2.2	2.8	3.6	4.5
Heating	kBtu/h	8.5	10.9	13.6	17.1
	kW	2.5	3.2	4	5
ELECTRICAL PARAMETERS					
Power supply	Ph/V/Hz	1P/220-230V/50-60Hz			
PERFORMANCE					
Airflow (LS/MS/HS)	m³/h	480/420/360	480/420/360	550/430/370	600/540/460
Noise level (LS/MS/HS)	dB(A)	27/24/21	27/24/21	30/28/25	33/30/27
Sound power level (LS/MS/HS)	dB(A)	41/38/35	41/38/35	44/42/39	47/44/41
INSTALLATION					
External dimensions (WxHxD)	mm	850x420x185	850x420x185	850x420x185	850x420x185
Shipping dimensions (WxHxD)	mm	1045x540x270	1045x540x270	1045x540x270	1045x540x270
Net weight/Gross weight	kg	17.5/22.5	17.5/22.5	17.5/22.5	18.5/23.5
Liquid pipe diameter	inches	1/4"	1/4"	1/4"	1/4"
Suction pipe diameter	inches	3/8"	3/8"	1/2"	1/2"
External static pressure (standard/max)	Pa	0/30	0/30	0/30	0/30
Motorized panel and return air grill		7ACVF0587	7ACVF0587	7ACVF0587	7ACVF0587



+ PRODUCTS

- Wired controller RWW05 included.
- Wide range.
- Quiet solution.



RWW05
(included)



RCV02
(optional)



RWW03
(optional)



RWW07
(optional)

FEATURES

TECHNOLOGY:





+ PRODUCTS

- Flexible static pressure selection, meeting the customers' personal requests.
- High efficiency filter.
- Water pump integrated.
- EEV inside.
- Wired controller RWV05 included.



RWV05
(included)



RCV02
(optional)



(RECO1
infrared
receiver to
combined
with RCV02)



RWV03
(optional)



RWV07
(optional)

FEATURES

TECHNOLOGY:



R410A FLUID



ELECTRONIC
EXPANSION VALVE

INSTALLER FUNCTIONS:



INTEGRATED WATER
PUMP

- Invisible solution.
- Two choices of static pressure: better fitting with aeraulic network.
- Built-in high head pump (height up to 700 mm).
- Plenum for air outlet provided: 3xØ200 sizes 018 and 028, 4xØ200 size 038.
- Dry contact: hotel/bungalow solutions (room card or on/off contact).

DBV TECHNICAL DATA

Indoor unit					Drop only		Drop only
		AWSI-DBV 018-N11	AWSI-DBV 024-N11	AWSI-DBV 028-N11	AWSI-DBV 030-N11	AWSI-DBV 038-N11	AWSI-DBV 048-N11
Phase		Single phase	Single phase	Single phase	Single phase	Single phase	Single phase
Part number		7SP03H035	7SP03H036	7SP03H037	7SP03H038	7SP03H039	7SP03H040
RATED POWER							
Cooling	kBtu/h	19.1	24.2	27.3	30.7	38.2	47.8
	kW	5.6	7.1	8	9	11.2	14
Heating	kBtu/h	21.5	27.3	30.7	34.1	44.3	55.6
	kW	6.3	8	9	10	13	16.3
ELECTRICAL PARAMETERS							
Phase/Voltage/Frequency		1P/230V/50Hz					
PERFORMANCE							
Airflow (LS/MS/HS)	m³/h	699/805/920	950/1090/1230	950/1090/1230	930/1180/1500	900/1300/1700	1250/1700/2000
Noise level (LS/MS/HS)	dB(A)	36/38/40	38/40/42	39/43/46	38/42/46	39/43/46	39/44/47
INSTALLATION							
External dimensions (WxHxD)	mm	1050x720x250	1050x720x250	1050x720x250	1100x700x248	1500x700x248	1500x700x248
Shipping dimensions (WxHxD)	mm	1170x860x340	1170x860x340	1170x860x340	1332x835x280	1698x857x305	1698x857x305
Net weight/Gross weight	kg	30.5/35.9	33.1/38.5	33.1/38.5	39.4/45.4	48.3/56.5	51.3/59.5
Liquid pipe diameter	inches	1/2"	3/8"	3/8"	3/8"	3/8"	3/8"
Suction pipe diameter	inches	1/4"	5/8"	5/8"	5/8"	5/8"	5/8"
Static pressure	Pa	50	50	50	50	50	50
Max. static pressure	Pa	100	100	100	100	100	100



DCV 048



DCV 072-096



- Invisible solution.
- Static pressure up to 196 Pa.
- Commercial application: high airflow and capacity up to 28 kW.
- Compatible with a textile duct application.



DCV TECHNICAL DATA

		Drop only						
Indoor unit		AWSI-DCV018-N11	AWSI-DCV024-N11	AWSI-DCV030-N11	AWSI-DCV038-N11	AWSI-DCV048-N11	AWSI-DCV072-N11	AWSI-DCV096-N11
Phase		Single phase	Single phase	Single phase	Single phase	Single phase	Single phase	Single phase
Part number		7SP03H014	7SP03H015	7SP03H016	7SP03H017	7SP03H018	7SP03H019	7SP03H020
RATED POWER								
Cooling	kBtu/h	19.1	24.2	30.7	38.2	47.7	77.1	95.5
	kW	5.6	7.1	9	11.2	14	22.6	28
Heating	kBtu/h	21.5	27.3	34.1	42.6	54.6	85.3	108.5
	kW	6.3	8	10	12.5	16	25	31.5
ELECTRICAL PARAMETERS								
Phase/Tension/Frequency		1P/220-230V/50Hz						
PERFORMANCE								
Airflow (LS/MS/HS)	m³/h	1089/1357/1500	1089/1357/1500	1133/1412/1560	1162/1448/1600	1525/1901/2100	2612/3255/4050	2612/3255/4050
Noise level (LS/MS/HS)	dB(A)	38/40/42	38/40/42	40/43/45	40/43/45	40/43/45	49/51/54	49/51/54
INSTALLATION								
External dimensions (WxHxD)	mm	975x906x360	975x906x360	1355x876x360	1355x876x360	1197x360x830	1570x360x880	1570x360x880
Shipping dimensions (WxHxD)	mm	1048x943x413	1048x943x413	1378x938x405	1378x938x405	1430x420x940	1800x525x1000	1800x525x1000
Net weight/Gross weight	kg	48/58	48/58	62/77	62/77	62/77	100/111	100/111
Liquid pipe diameter	inches	1/4"	3/8"	3/8"	3/8"	3/8"	3/8"	3/8"
Suction pipe diameter	inches	1/2"	5/8"	5/8"	5/8"	5/8"	1"	1"
Static pressure	Pa	100/196	100/196	100/196	100/196	196	196	196

Dimensions: 018-024/030-038/048 models

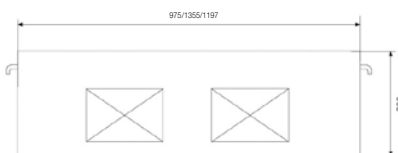

Dimensions: 072-096 models

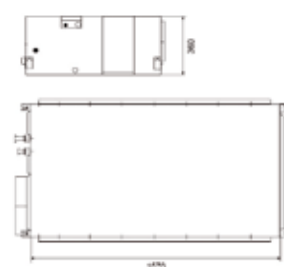

+ PRODUCTS

- High efficiency filter.
- Free setting of air discharge duct.
- Water pump in option.
- High external static pressure design.



RWV05 (included)



RCV02 (optional)



RWV03 (optional)



RWV07 (optional)

FEATURES

TECHNOLOGY:



R410A FLUID



ELECTRONIC EXPANSION VALVE

INSTALLER FUNCTIONS:



WATER PUMP (OPTIONAL)



+ PRODUCTS

- High efficiency filter.
- Quiet running.
- Compact unit body and space saving.
- EEV inside.
- Wireless controller included.



RCV02
(included)



RWW05
(optional)



RWW07
(optional)

FEATURES

TECHNOLOGY:



R410A FLUID



ELECTRONIC EXPANSION VALVE



- Esthetic and compact design: 210 mm.
- Ideal solution to replace electric heaters.
- Blowing up and down.
- Dry contact: hotel/bungalow solutions (room card or on/off contact).
- 5 speed airflow.

EAV TECHNICAL DATA

Indoor unit		AW-EAV009-N11	AW-EAV012-N11	AW-EAV018-N11
Phase		Single phase	Single phase	Single phase
Part number		7SP05H005	7SP05H006	7SP05H007
RATED POWER				
Cooling	kBtu/h	9.5	12.3	17
	kW	2.8	3.6	5
Heating	kBtu/h	10.9	13.6	18.5
	kW	3.2	4	5.5
ELECTRICAL PARAMETERS				
Phase/Tension/Frequency		1P/230V/50Hz		
PERFORMANCE				
Airflow (VL/LS/MS/HS/VH)	m ³ /h	45/48/52/55/58	47/51/54/57/60	48/52/55/58/61
Noise level (VL/LS/MS/HS/VH)	dB(A)	540/460/390/310/270	580/500/420/350/270	620/540/460/390/270
INSTALLATION				
External dimensions (WxHxD)	mm	700x600x210	700x600x210	700x600x210
Shipping dimensions (WxHxD)	mm	783x695x303	783x695x303	783x695x303
Net weight/Gross weight	kg	15.2/18.7	15.2/18.7	15.2/18.7
Liquid pipe diameter	inches	1/2"	1/2"	1/2"
Suction pipe diameter	inches	1/4"	1/4"	1/4"

Dimensions: 009-018 models

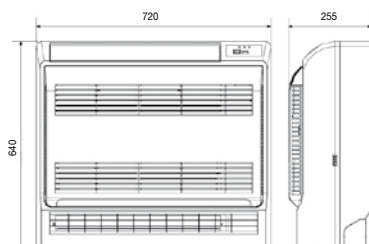

A series of horizontal dotted lines for writing.



AHU connection kit

Airwell offers a range of connection kits to connect VRF outdoor units to third party DX air handling units.

SYSTEM APPLICATION

- Provides a solution for big space to cool down the supplied fresh air with VRF outdoor units to match the air handling units. Integrates all advantages of VRF and AHU units.
- EU legislation requires that every working place has to be supplied with a minimum of 25 m³/h/person of fresh air. So it means that every office, every shop and mostly every commercial building must have this solution in order to comply with the standard.



Buildings



Shopping centres



Hospitals

■ CONFIGURATION BETWEEN 14 AND 28 KW

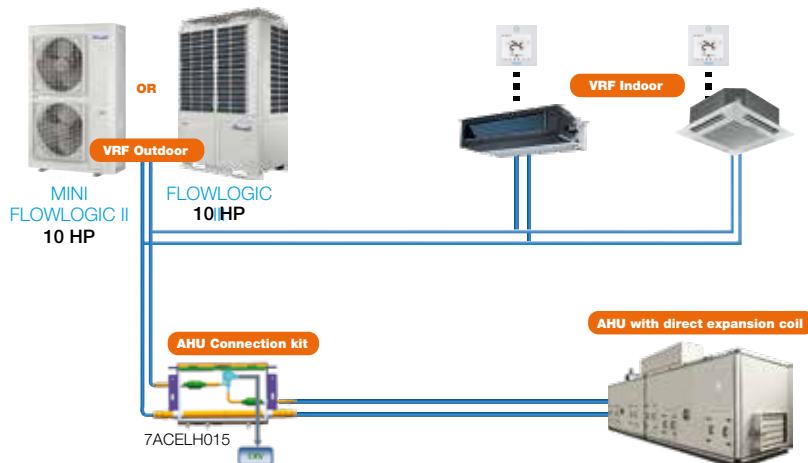

5 HP (14 kW) < Connected AHU capacity ≤ 10 HP (28 kW)

AHU and direct expansion coil to be purchased through other supplier

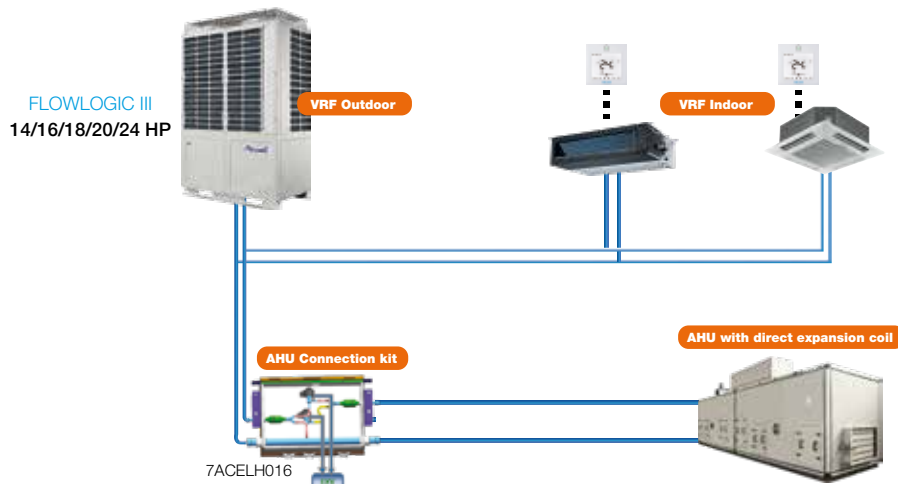

■ CONFIGURATION BETWEEN 28 AND 56 KW



10 HP (28 kW) < Connected AHU capacity ≤ 20 HP (56 kW)

AHU and direct expansion coil to be purchased through other supplier

VRF OUTDOOR LINE UP

Outdoor unit	MINI FLOWLOGIC II	FLOWLOGIC III
Model	All range	All range
		
Power supply	3P/380-400V/50Hz 3P/380-400V/60Hz	3P/380-400V/50Hz - 3P/380-400V/60Hz 3P/220V/60Hz - 3P/460V/60Hz
AHU kit	7ACELH015 5 HP (14 kW) < Connected AHU capacity ≤ 10 HP (28 kW)	7ACELH016 10 HP (28 kW) < Connected AHU capacity ≤ 20 HP (56 kW)

AHU KIT CONFIGURATION

Airwell AHU connection kit consists in the following 4 parts:

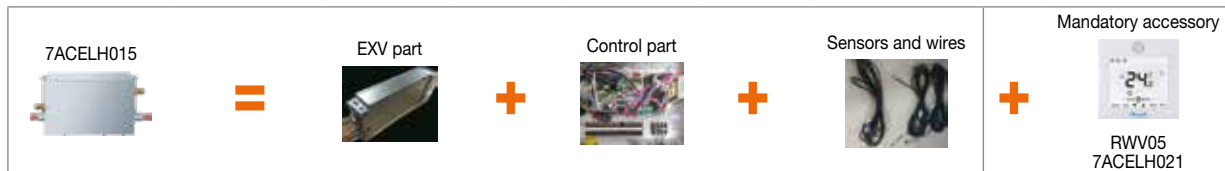

Different Valve ▼ Same Control Parts



- EXV part, control part, sensor and wire are all integrated in one box.
- Controller need to be purchased separately.
- Temperature control *via* outlet air sensor on AHU.

WIRING DIAGRAM

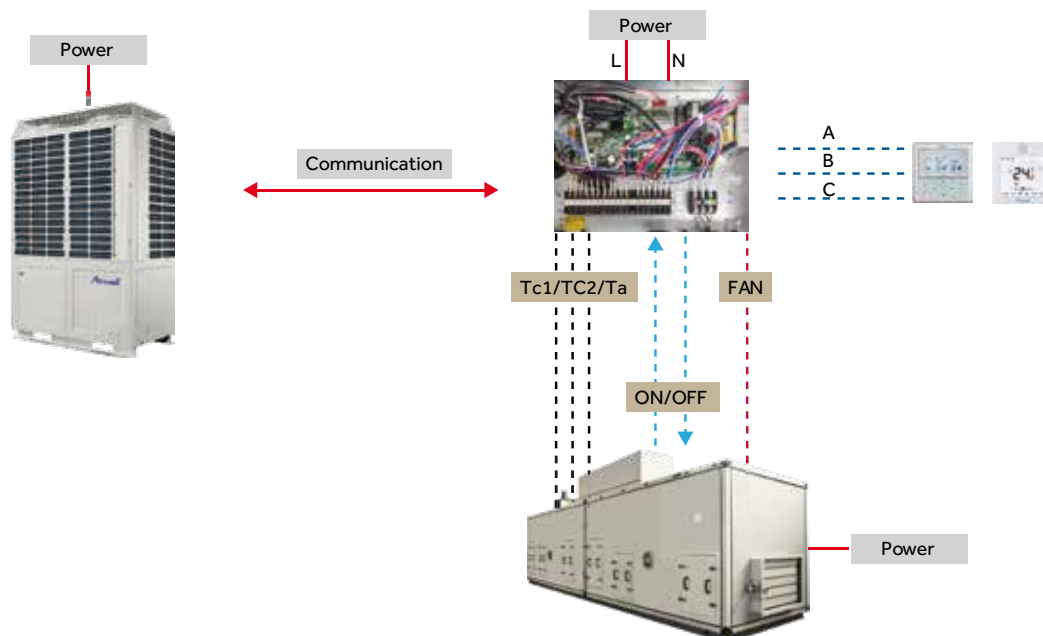

Central control solutions with ADV05

ONLY ONE GATEWAY: CENTRAL CONTROL OR MODBUS

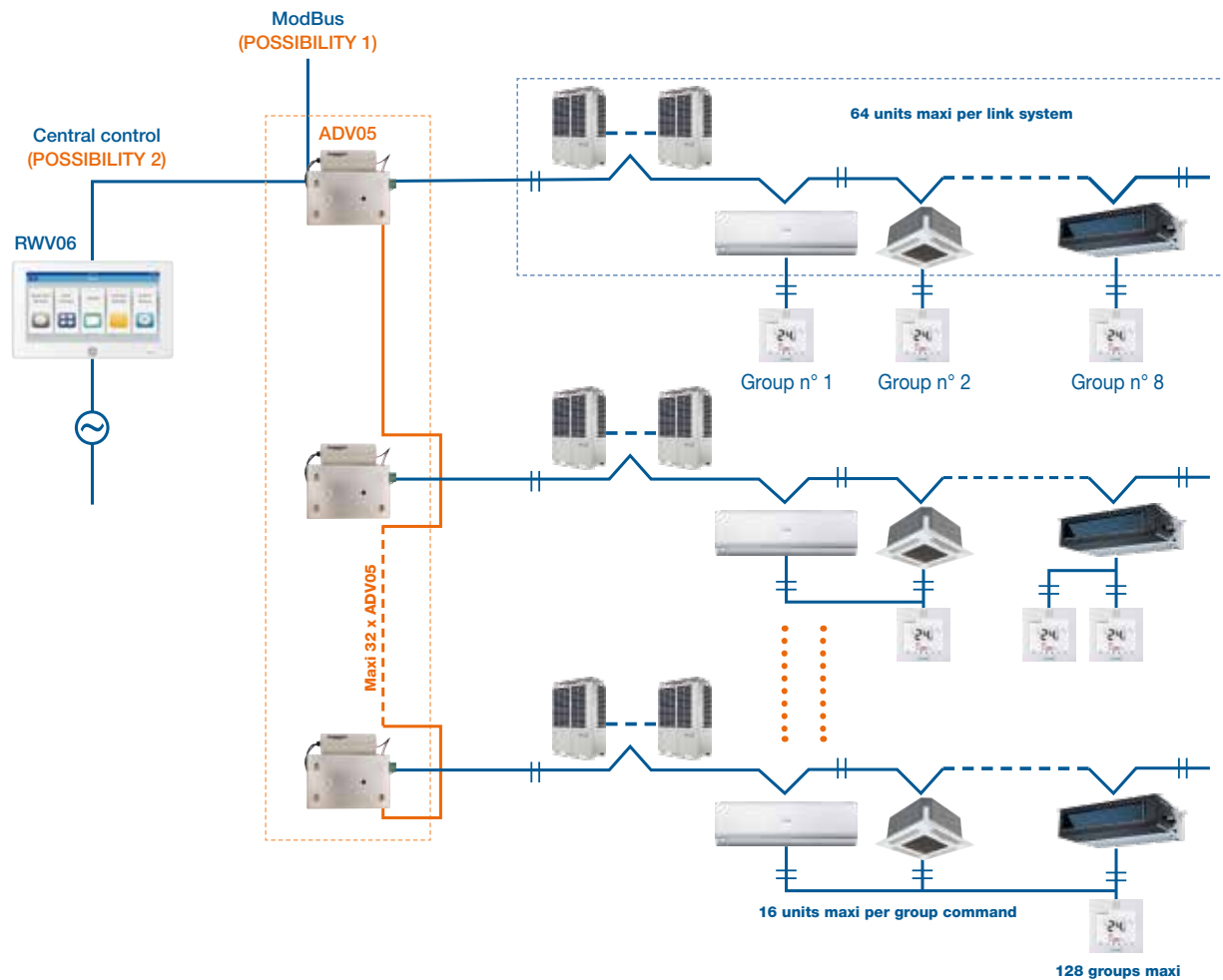

TOUCH SCREEN CENTRAL REMOTE CONTROL RWV06

This command allows you to control and monitor the status of indoor units:







- Modern design
- Intuitive and simple operation thanks to its 7" touch screen
- Can monitors until 256 indoor units and 128 groups



The main functions are:

- Reading operating parameters
- Visualization of failure code
- Weekly time: mode, fan speed, temperature
- Sets LIFO (last enter have high priority)
- Creation and monitoring zones
- ModBus RS485 -+

Part number RWV06: 7ACELH023

ACCESSORY NAME		Photo	Part number	Model
CONTROLLERS	INFRARED CONTROLLER		7ACELH022	RCV02
	INFRARED CONTROLLER RECEIVER		7ACELH009	REC01
	SIMPLIFIED CONTROLLER		7ACELH008	RWV03
	WIRED STANDARD CONTROLLER		7ACELH021	RWV05
	WIRED CONTROL WEEKLY TIMER		7ACELH024	RWV07
	MINI CENTRAL CONTROLLER		7ACELH025	RWV08
	CENTRAL CONTROLLER "TOUCH SCREEN"		7ACELH023	RWV06
BMS SOLUTIONS & MAINTENANCE	CENTRAL CONTROLLER GATEWAY AND MODBUS/RTU		7ACELH027	ADV05
	MAINTENANCE TOOL		7ACELH014	TD02

FUNCTION	FOR WHAT UNITS?	OPTION/COMMENT
On/Off, set temperature, auto scan, mode, individual control, timer.	All indoor units.	Standard with high wall and console, optional with cassette and ducted.
Realize infrared control.	Ducted	-
Unit operating and group control (max. 16 indoor units).	All indoor unit types (except for console).	-
Unit operating, group control (max. 16 indoor units) and "I Feel" function.	High wall, ducted cassette, floor ceiling.	Standard with cassette, ducted and floor ceiling.
Single unit control, group control, max. 16 units, weekly timer, clock, mode cooling/heating/auto/airflow/dehumidification, temperature, fan speed, fan direction.	High wall, cassette, ducted, floor ceiling.	-
32 indoor units max., individual control, group control, central control, weekly timer, error display.	Mini FlowLogic II FlowLogic III FlowLogic II HR	ADV05 mandatory.
Central control, single unit control, group control, max. 256 units, weekly timer, clock, mode cooling/heating/auto/airflow/dehumidification, temperature, fan speed, fan direction.	Mini FlowLogic II FlowLogic III FlowLogic II HR	ADV05 mandatory.
RWV06 and RWV08 adaptor and ModBus RTU gateway.	Mini FlowLogic II FlowLogic III FlowLogic II HR	-
Working parameters monitoring and recording tool.	Mini FlowLogic II FlowLogic III FlowLogic II HR	-

Airwell

AIR CONDITIONING & HEATING

Our after-sales service

tel ■ +33 (0)1 76 21 82 95

SPARE PARTS ORDERS:
e-mail ■ sp@airwell-res.com

TECHNICAL SUPPORT:
e-mail ■ sav@airwell-res.com

Airwell
Residential

3, AVENUE DU CENTRE, LES QUADRANTS, BÂT. A - 78280 GUYANCOURT, FRANCE
TEL.: +33 (0)1 76 21 82 00 - www.airwell-res.com