

# Airwell

CLIMATISATION ET CHAUFFAGE

User manual EN



## XDO

Direct expansion console water source

DC Inverter technology

Silent heat pump

---

We would first of all like to thank you for having chosen one of our products.

We are sure you will be happy with it because it represents the state of the art in the technology of home air conditioning.

By following the suggestions contained in this manual, the product you have purchased will operate without problems, giving you optimum room temperatures with minimum energy costs.

Airwell.

## Compliance

This unit complies with the following European Directives:

- Low voltage 2014/35/EU
- Electro-magnetic compatibility 2014/30/EU
- Use restrictions of hazardous substances in electrical and electronic equipment 2011/65/EC (RoHS2)
- Waste electrical and electronic equipment 2012/19/EC (WEEE).
- Energy consumption indication on the labels of energy-related products 2010/30/EU.
- ErP Directive 2009/125/EC and regulation 2012/20EC

## Symbols



The pictograms in the next chapter provide the necessary information for correct, safe use of the appliance in a rapid,

unmistakable way.

### Editorial pictograms

- |   |   |
|---|---|
| <b>U</b> User   | <b>S</b> Service  |
| - Refers to pages containing instructions or information for the user.      | - Refers to pages containing instructions or information for the CUSTOMER TECHNICAL ASSISTANCE SERVICE installer. |
| <b>I</b> Installer  |   |
| - Refers to pages containing instructions or information for the installer. |   |

### Safety pictograms

- |   |   |
|---|---|
|  Warning |  Prohibition |
| - It indicates actions that require caution and a suitable preparation.                     | - Refers to prohibited actions.   |

## General table of contents

User manual		
1.1	Warnings	4
1.2	Management of the appliance with the touch-screen display and remote control	4
1.3	Description of operations	6
1.4	Setting cool only or heat only modes	8
1.5	Brightness regulation	8
1.6	Touch-screen display key lock	8
1.7	Hotel function	8
1.8	Suggestions for power saving	8
1.9	Diagnosis of problems	9
1.10	Technical specifications	11
1.11	Periodic Maintenance	12

## USER MANUAL



















### 1.1 Warnings

- ⚠ Objects or structural obstacles (furniture, curtains, plants, leaves, blinds, etc.) must not obstruct the normal air flow both from the internal and from the external grids.
- ⚠ It is strictly forbidden to place any containers on top of the appliance, especially if they contain liquid. This could trigger a short-circuit, damage the appliance and/or expose the user to the risk of electrocution.
- ⚠ Do not lean against, or worse sit on, the body of the conditioner, this would damage the appliance.
- ⚠ Do not move the horizontal air outlet flap manually. Always use the remote control to perform such operation.
- ⚠ In the event of water leaks, turn off the appliance and disconnect the electric power supply. Call the nearest service centre.
- ⚠ The appliance must not be installed in rooms where explosive gases develop or where there are humidity and temperature conditions that exceed the maximum levels reported on the installation manual.
- ⚠ Clean the air filter regularly as described in the specific paragraph.

### 1.2 Managing the appliance with the touch-screen display and the remote control

- 1 Corresponding button on remote control
- 2 Corresponding button on touch-screen display

**BUTTON / DISPLAY:**

- |   |  |
|---|--|
|  Setpoint                                    |  Heating only button (2)  |
|  Up button                                   |  Nocturnal well-being button                                      |
|  Down button                                 |  Control of air flow direction button                             |
|  On/off button                               |  Fan speed control button   |
|  Well-being button (economic automatic mode) |  Timer mode setting button (1)                                    |
|  Cooling only mode button                    |  Timer mode setting button (2)                                    |
|  Dehumidification only mode button           |  Brightness sensor  |
|  Ventilation only mode button                |  Digital thermometer; 1÷7 red bars in winter, blue bars in summer |
|  Heating only button (1)                     |  Not used   |



Normally, the display shows the operating status (see paragraph entitled Description of operations), as well as any alarms (see paragraph entitled Display alarms).

In addition, it is possible to select the various functions by pressing the symbols.

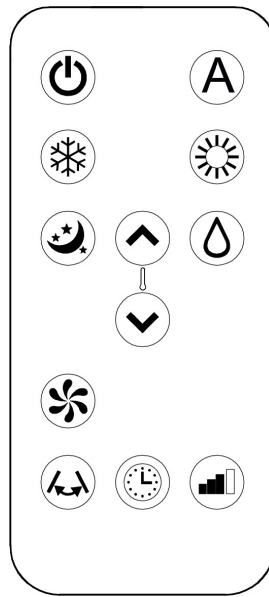

It is possible to select the various modes by pressing the buttons (see paragraph entitled Description of operations).

**⚠** The remote control provided has been designed to be functional and hard-wearing, however, it must be handled cautiously.

Avoid:

- leaving it exposed to rain, pouring liquids on it or dropping it into water
- hitting it or dropping it on hard surfaces
- leaving it under the sun

- placing obstacles between the remote and the appliance while using it.

In addition:

- if there are other appliances using remote controls in the room (TV, radios, stereos, etc.), interferences may occur
- electronic or fluorescent lamps can interfere with communication between the remote and the appliance
- remove the battery if not using the remote for a long time.

### Battery insertion

Only CR2012 3V dry lithium batteries must be used (supplied). Used batteries must be handed over to the specific collection areas as arranged by the Local Authorities for this type of waste.

In order to insert the batteries, open the specific cover in the bottom part of the remote. The battery must be inserted respecting polarity. Once the battery is inserted, close the cover.









1.3 Description of operations

General start-up and management

In order to manage the appliance using the remote control and the touch-screen, the main switch on the electrical power supply line must be turned on (its exact position can be indicated by the technician who installed the appliance) or the power supply plug must be connected to the system socket. Once such operations have been performed, it is possible to manage the system by holding down the symbols on the

touch-screen (for 3 seconds) or by using the remote control. In order to send commands to the internal unit, the top part of the remote must point towards the display of the internal unit. The reception of the command is confirmed by a beep and by the display. The maximum distance for the remote control to work is approximately 8 metres.

Key/Display	Operation
	The keys of the remote control and of the touch screen display perform the same functions.
	When the unit is turned on, the 3 digits on the display will show the set-point.
	<ul style="list-style-type: none"> <li>It is possible to set the set-point between 16 and 31°C, to which temperature the unit will bring the room.</li> </ul>
	<p> If the temperature is set too low or too high, not only it is unhealthy, but it is also an unnecessary waste of energy.</p>
<b>Switching the appliance on and off</b>	
	<p>It is possible to switch the appliance on or off (stand-by) by pressing the specific button. The control system of the appliance is equipped with a memory, so settings will not be lost if the appliance is switched off or in the power supply is cut. This key is used to activate or deactivate the appliance for short periods of time.</p> <p> In case of long periods of inactivity, the appliance must be deactivated by disconnecting either the main switch or the plug from the socket.</p>
<b>Well-being button (economic automatic mode)</b>	
	<p>By choosing this mode on the appliance, it sets the best level of comfort in the room. The conditioner selects the mode automatically (cooling or heating) according to the temperature set and ventilation speed according to the temperature of the room.</p>
<b>Cooling only mode</b>	
	<ul style="list-style-type: none"> <li>In this mode, the appliance dehumidifies and cools the room.</li> </ul>
	<ul style="list-style-type: none"> <li>It is possible to set the desired temperature between 16 and 31°C and, if this temperature is lower than the room temperature, the compressor starts up after three minutes (maximum) and the appliance starts dispensing cool air, maintaining ventilation active even if the setpoint has been reached.</li> </ul>
	
<b>Dehumidification only mode</b>	
	In this mode, the appliance dehumidifies the room. Selecting this mode is useful during mid-seasons, i.e. on days (e.g. rainy ones) when the temperature is pleasant, but excess humidity causes discomfort. This mode ignores both room temperature and ventilation speed settings. The latter is always set to a minimum. It is normal for the appliance to work intermittently.
<b>Ventilation only mode</b>	
	By selecting this function, the compressor is never activated and the appliance does not affect either room temperature or humidity. It is possible to choose the speed of the fan.
<b>Heating only mode</b>	
	<ul style="list-style-type: none"> <li>In this mode, the appliance heats the room.</li> </ul> <p> Set on heating only mode, the appliance periodically defrosts the evaporator coil, if necessary. During this phase, the conditioner does not dispense warm air, even if its internal components are on, except for the room fan.</p>
	<ul style="list-style-type: none"> <li>It is possible to set the desired temperature between 16 and 31°C and, if such temperature is higher than the room temperature, the compressor starts up after three minutes (maximum) and the appliance starts dispensing warm air.</li> </ul>
	

Key/Display	Operation
	<p><b>Nocturnal well-being button</b></p> <p>While the appliance is on in the selected cooling or heating mode, it is possible to choose different functions by pressing the button in order to maximise noise reduction, energy saving and nocturnal well-being regulation. In this mode, ventilation is set on minimum speed. This mode should be activated right before going to sleep.</p> <ul style="list-style-type: none"> <li>• In cooling mode, the set temperature is increased by 1°C after one hour and by another degree after two. After the second hour, the temperature is no longer changed and, after six hours, the appliance is put in stand-by.</li> <li>• In heating mode, the set temperature is lowered by 1°C after one hour and by another degree after two. After the second hour, the temperature is no longer changed and, after six hours, the appliance is put in stand-by.</li> </ul> <p>This function is not available for dehumidification only, ventilation only and economic automatic modes and can be excluded any time (ideally once awake) by pressing the button again. If the Timer has also been set, the appliance will turn off at the set time.</p>
	<p><b>Control of air flow direction</b></p> <p>By pressing the specific button, it is possible to either select the continuous oscillation of the mobile air outlet flap - in such case, the symbol on the display is lit - or to block it in any position.</p> <p><b>⚠ IMPORTANT:</b> The mobile flap must never be moved manually. In cooling and dehumidification modes, the position of the flap is reset every 30 minutes to prevent dew from forming.</p>
	<p><b>Fan speed control (models XDO 9 and 12)</b></p> <p>By pressing this button several times, the speed will change according to the following sequence: Minimum, Medium, Maximum, Boost and Automatic. The higher the speed is set, the better the appliance will perform, but it will be less quiet. By selecting Automatic mode (shown by three speed bars moving up and down on the display), the on-board microprocessor automatically adjusts the speed, so that it stays higher the greater the difference between the temperature detected and the temperature set. The speed will always be automatically decreased as the room temperature approaches the set temperature. This is not possible in humidification only or nocturnal well-being mode where the appliance can only operate at a low speed.</p> <p><b>Setting power for models XDO 9 and 12</b></p> <p>By pressing this key sequentially, it is possible to set the power supplied by the appliance on 5 adjustments: Minimum, Medium, Maximum, Boost and Automatic. The higher the power is set, the better the appliance will perform, but it will be less quiet. The Dual Power function (shown by three flashing speed bars on the display and the seven red or blue bars moving up and down of the digital thermometer), available only in heating and cooling mode, supplies a 30-minute Overboost. Then, the controller inhibits the function and switches to automatic mode. By selecting Automatic mode (shown by three speed bars moving up and down on the display), the on-board microprocessor automatically adjusts the speed, so that it stays higher the greater the difference between the temperature detected and the temperature set. This is not possible in humidification only or nocturnal well-being mode where the appliance can only operate at a low speed.</p>
	<p><b>Setting the Timer function</b></p> <ul style="list-style-type: none"> <li>• The appliance allows the user to program when to turn it on and off, as required.</li> </ul>
	<ul style="list-style-type: none"> <li>• While the conditioner is running, it is possible to schedule when it turns off by pressing the Timer button, followed by the number of hours (from 1 to 24), after which the unit will be put in stand-by.</li> </ul>
	<ul style="list-style-type: none"> <li>• When the air conditioning unit is off, it is possible to schedule when it turns on by pressing the Timer button, followed by the number of hours (from 1 to 24) after which the unit will start.</li> </ul>
	<ul style="list-style-type: none"> <li>• Then, press the confirm button.</li> </ul>
	<p><b>Touch-screen display key lock</b></p> <ul style="list-style-type: none"> <li>• The key lock is activated by keeping the Timer symbol on the touch-screen display pressed for three seconds. The user cannot perform any actions. The stand-by symbol flashes every second.</li> <li>• To deactivate the lock, keep the Timer symbol pressed for three seconds once again.</li> </ul> <p><b>⚠</b> The lock remains active in the case of a power failure and also if the remote control is used!</p>

### 1.4 Setting cool only or heat only modes

It is possible to deactivate the heating or the cooling modes following a simple procedure.

Keep the A key on the touch-screen display pressed for 5 seconds until HC (heating and cooling) appears on the display.

Press the A key for 1 second to switch to the CO (cooling only) mode.

Press the A key again to switch back to HO (heating only) mode.

Wait for 3 seconds without touching anything to memorise the setting and return to normal operations.

### 1.5 Brightness regulation

The display brightness sensor can be disabled (leaving the maximum brightness at all times) by pressing and holding

the night button (☾) for 10 seconds.

"ds" (disabled) or "En" (enabled) will appear on the display.

### 1.6 Touch-screen display key lock

The key lock is activated by keeping the  Timer symbol on the touch-screen display pressed for three seconds.

The user cannot perform any actions.

The stand-by symbol flashes every second.

To deactivate the lock, keep the Timer symbol pressed for three seconds once again.

The lock remains active also for the next operations performed via remote control and in the event of a power failure.

### 1.7 Hotel function

Press and hold the air exchange key (  ) for 10 seconds to enable the function ("En" displayed); the dehumidification and Auto functions are disabled (leaving active only

ventilation, heating and cooling) and the settable set range is reduced from 22 to 28 in cooling mode and from 16 to 24 in heating mode).

### 1.8 Suggestions for power saving

- Always keep the filters clean (see maintenance and cleaning chapter).
- Keep the doors and windows of the rooms to be air conditioned closed  
Do not let direct sunlight to enter the room (use curtains

- or lower the blinds or close the shutters)
- Do not block the air flow paths (input and output) of the unit; this, as well as causing a non-optimal performance of the unit, will jeopardise the correct operation of the same and may cause irreparable damage to the units.



**1.9 Diagnosis of problems**

For the User it is very important to distinguish any inconveniences or abnormal operation of the unit compared to its normal operation. Also, the most common problems can be easily solved by means of simple operations performed by the User (See paragraph: Troubleshooting), while for some alarms signalled on the display, it is

necessary to contact Customer Service.

**⚠** We also remind you that any attempt to repair the unit on part of unauthorised technicians will void the warranty immediately.

**Operating aspects that should not be interpreted as problems**

- The compressor will not restart before a certain time has passed (about three minutes from the previous stop). It is not possible to stop and restart the compressor without waiting at least three minutes. This is provided for in the operating logic of the unit, so as to protect the compressor from frequent activations.

- During operation in heating mode, the warm air is delivered a few minutes after the activation of the compressor. If the fan started at the same time as the compressor, in the first minutes of operation the air delivered would be too cold (which may disturb the occupants of the room) since the unit is not yet ready.

**Open CP contact**

If the presence contact is not closed, the appliance will not

start and the **CP** alarm appears on the display.

**Evacuation of condensate water in the event of an emergency**

Should any anomaly occur in the condensation water system, the maximum level float blocks the conditioner and the **OF** code appears on the display. If the problem persists, please contact the assistance service. During heating, condensation should drain freely through

the specific pipe. In the event of an alarm, check that the condensation pipe is not bent or obstructed, thus preventing the water from flowing out.

**Using the unit if the remote control is not available**

If the remote control has been lost, the batteries are exhausted or it no longer works, the unit can be operated by using the keys on the touch

screen display on the machine.

**Troubleshooting**

In the event of a malfunction, please refer to the following table. please contact the authorised technical assistance.  
 If, after performing the suggested checks, the problem is not solved,

Fault	Possible causes	Solution
The appliance doesn't switch on	No power supply	Check there is power supply (by turning a light on, for example). Check that the thermal-magnetic circuit breaker used exclusively to protect the appliance has not been tripped (if it has, reset it). If the problem repeats immediately, please call the Service Centre and avoid trying to make the appliance work.
	Remote control batteries have run out	Check that the appliance can be turned on using the touch-screen display and substitute the batteries.
The appliance does not cool/heat adequately.	The temperature set is too high or too low.	Check and adjust the temperature, if necessary.
	The air filter is clogged	Check the air filter and clean it if necessary
	Make sure that the air flow is not obstructed.	Remove anything that might block the air flow.
	The heating and cooling load has increased (for example, a door or a window has been left open or an appliance has been installed in the room which generates a lot of heat).	Try to reduce the heating and cooling load of the room following instructions below: <ul style="list-style-type: none"> <li>• Cover large windows exposed to sunlight with curtains or with external maskings (blinds, porches, reflecting films, etc.);</li> <li>• The air conditioned room must remain closed for as long as possible;</li> <li>• Avoid turning on halogen lamps or other high energy consumption appliances such as small ovens, steam irons, hot plates etc.).</li> </ul>

**Display alarms**

An alarm code appears on the display in the event of faults. FUNCTIONING column).  
 Some of the functions, however, remain active (see

Alarm	Cause	Operation
E1	Faulty room temperature RT sensor	It is still possible to activate Cooling, Dehumidification and Heating modes. It only monitors the antifreeze function of the internal coil.
E2	Faulty internal coil IPT sensor	It is still possible to activate Cooling, Dehumidification and Heating modes.
E3		
E4	Faulty external coil OPT sensor	None of the modes can be activated.
E5	Faulty internal fan motor	None of the modes can be activated.
E6	Antifreeze/High condensation alarm	None of the modes can be activated.
E7	Lack of communication with the display *	None of the modes can be activated.
E8	Compressor discharge probe failure	None of the modes can be activated.
CP	Open CP contact	The appliance only works if the contact is closed. Check that the clamps are connected.
OF	Maximum level float intervention	The condensate should flow freely through the dedicated pipe. In the event of an alarm, check that the condensation pipe is not bent or obstructed, thus preventing the water from flowing out.

\* for models XDO 9 and 12 DC Inverter: lack of communication between the main, power, driver or display boards.

The only way to solve the problem is to disconnect and reconnect the appliance. If the alarm still appears, please contact the authorised technical assistance.

1.10

Please read data plate to obtain the technical data listed below.

- Power supply voltage
- Maximum absorbed power
- Maximum absorbed current
- Amount of refrigerant gas
- Casing protection rating

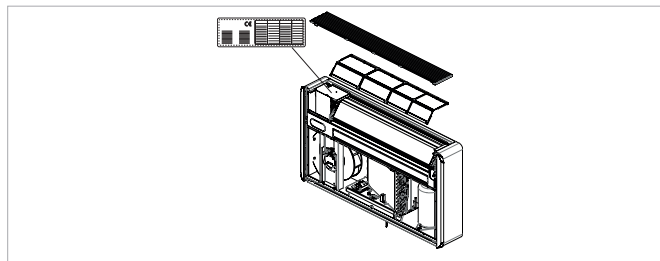

Technical specifications				
Size			XDO 09	XDO 012
<b>Cooling</b>				
Cooling capacity	1	kW	2.53	3.56
Total power input	1	kW	0.384	0.762
EER	1	-	6.58	4.67
<b>Heating</b>				
Heating capacity	2	kW	2.27	3,26
Total power input	2	kW	0.710	1.089
COP	2	-	3.20	3.00
<b>Compressor</b>				
Type of copressor		-	Inverter driven	Inverter driven
N° of compressor		-	1	1
Refrigerant gas			R-410A	R-410A
Refrigerant charge		kg	0.75	0.75
<b>Air handling section fan</b>				
Type of fan		-	Centrifugal	Centrifugal
Number of fan		-	1	1
Min. air flow rate		m³/h	195	220
Med. air flow rate		m³/h	250	310
Max. air flow rate		m³/h	310	410
Boost air flow rate		m³/h	385	435
<b>Water side exchanger</b>				
Type of exchanger		-	Coaxial	Coaxial
Water flow rate	3	l/s	0.139	0.206
Water fittings			Eurokonus M 3/4"	Eurokonus M 3/4"
<b>Power supply</b>				
Standard power supply		V/ph/Hz	230/1/50	230/1/50
<b>Noise Levels</b>				
Sound power level		dB(A)	52	57

**Note:**

The product is compliant with the ERP (Energy Related Products) European directive.

It includes Commission delegated Regulation (EU) No 2016/2281, also known as Ecodesign Lot 21

Performances referred to the maximum speed fan (Max.)

1) Cooling: inlet air temperature 27°C w.b./19°C d.b.; in/out water temperature 30°C/35°C

2) Heating: inlet air temperature 20°C; in/out water temperature 10°C/7°C (well source)

3) Water flow rate measured in cooling at maximum speed fan (Max.)

**Operating limits**

	Internal ambient temp.	Water inlet temp.
Maximum operating temperature in cooling mode	DB 35°C - WB 24°C	45° C
Minimum operating temperature in cooling mode	DB 18°C	7° C
Maximum operating temperatures in heating mode	DB 27°C	40° C
Minimum operating temperatures in heating mode	DB 5°C	7° C

### 1.11 Periodic Maintenance

The air conditioner you have bought has been designed to keep maintenance operations to a minimum, in fact, they

only include the following cleaning operations:

#### External cleaning

- ⚠ Disconnect the unit from the power supply before each cleaning and maintenance intervention by setting the main power supply switch to off.
- ⚠ Wait for the components to cool down in order to avoid any burns.

- ⚠ Do not use abrasive sponges or abrasive or corrosive detergents as you might damage the painted surfaces.

When necessary, clean the external surfaces with a soft damp cloth.

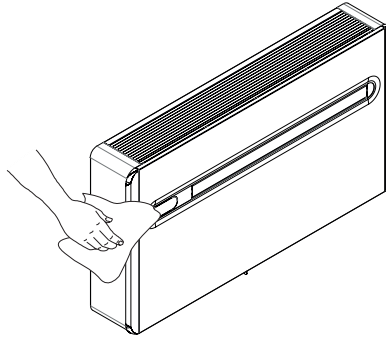

#### Cleaning the filters

The air conditioner you have bought has been designed to keep maintenance operations to a minimum, in fact, they only include the following cleaning operations:

- Clean the air filter after a period of continuous use and according to the concentration of impurities in the air, or when you wish to start-up the appliance after a period of inactivity. The filter is located in the top part of the appliance.

To extract the filters:

- open the grid and remove it;
- extract the filters by lifting them;
- remove the dust from the filter with a vacuum cleaner or by washing it in running water without using detergents or solvents and leave to dry;
- put the filters back on top of the batteries, taking care to position them correctly;
- put the grille back in reverse order.

- ⚠ After filter cleaning check if the panel is properly mounted.

⊘ It is forbidden to use the device without its mesh filter.

