

AIR CONDITIONER SPLIT WALL MOUNTED

ENGLISH

CLIMATISEUR SPLIT MURAL

FRANÇAIS

CLIMATIZADOR SPLIT MURAL

ESPAÑOL

CONDIZIONATORE D'ARIA A PARETE SPLIT

ITALIANO

KLIMAGERÄT IN SPLIT BAUWEISE

DEUTSCH

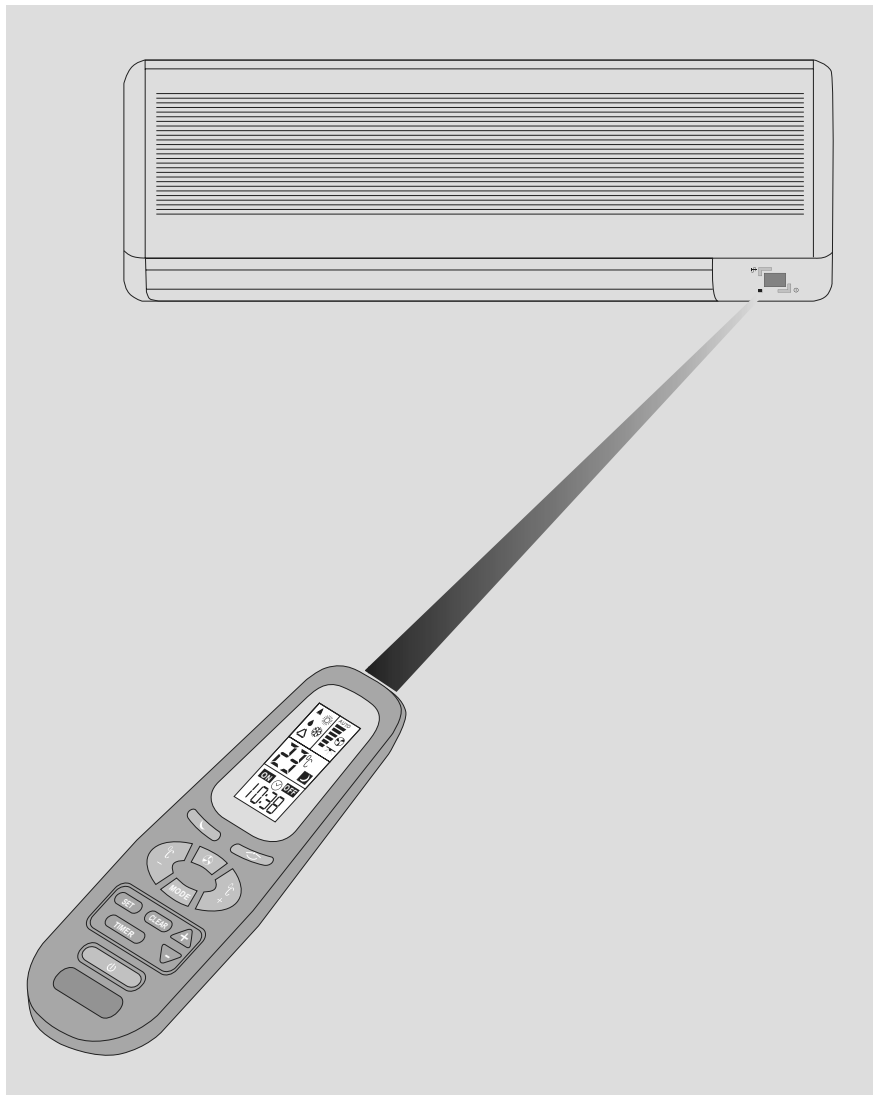

**PROGRAMMING AND OPERATING MANUAL
MANUEL D'UTILISATION ET DE PROGRAMMATION
MANUAL DE UTILIZACION Y DE PROGRAMACION
MANUALE DI UTILIZZO E DI PROGRAMMAZIONE
BEDIENUNGS UND PROGRAMMIERUNGS HANDBUCH**

ENGLISH

FRANÇAIS

ESPAÑOL

ITALIANO

DEUTSCH

CONTENTS

INTRODUCTION	1
SYSTEM DESCRIPTION	2
ON-UNIT INDICATORS AND CONTROLS	3
REMOTE CONTROL	4
OPERATION MODES, FUNCTIONS AND FEATURES	5
USE OF WIRELESS REMOTE CONTROL	7
OPERATION PROCEDURE	8
• Turning on the air conditioner	8
• Ventilating operation	8
• Cooling operation	8
• Cooling operation with auto fan mode	8
• Heating operation	8
• Heating operation with auto fan mode	8
• Auto cooling / heating operation	9
• Dry operation	9
• Selecting the temperature	9
• Sleep function	9
• Timer operation	10
• Automatic vertical air swing	11
• Turning off the air conditioner	11
• Current clock time set	11
PROTECTION MODES	12
CARE AND MAINTENANCE	13
OPERATING TIPS	14
PRECAUTIONS	15
BEFORE CALLING FOR SERVICE	16

*IF YOUR AIR
CONDITIONER IS FOR
COOLING ONLY, PLEASE
DISREGARD THE
HEATING INSTRUCTIONS*

*PLEASE READ THESE
INSTRUCTIONS BEFORE
OPERATING THE AIR
CONDITIONER*

INTRODUCTION

This Split Air Conditioner is designed for versatile applications:



- Cooling air in the summer.



- Dehumidifying the air at high humidity conditions.



- Heating.



- Ventilation.
-

OPERATING TEMPERATURE RANGE: <i>(According to T_1 temperature condition)</i>	
Cooling:	21° ~ 43°C
Heating:	-7° ~ 21°C

IMPORTANT NOTICE:

- This air conditioner must be grounded to protect against electrical shock.

- Installation of the air conditioner must be performed by an experienced air conditioning installer, observing good refrigeration practice.

- Electrical connections and power cord replacement should only be made by authorized electricians and in accordance with electrical regulations and local codes.

- Failure to comply with the manufacturer's installation and operation instructions could affect the performance of the air conditioner and the validity of the warranty.



SYSTEM DESCRIPTION

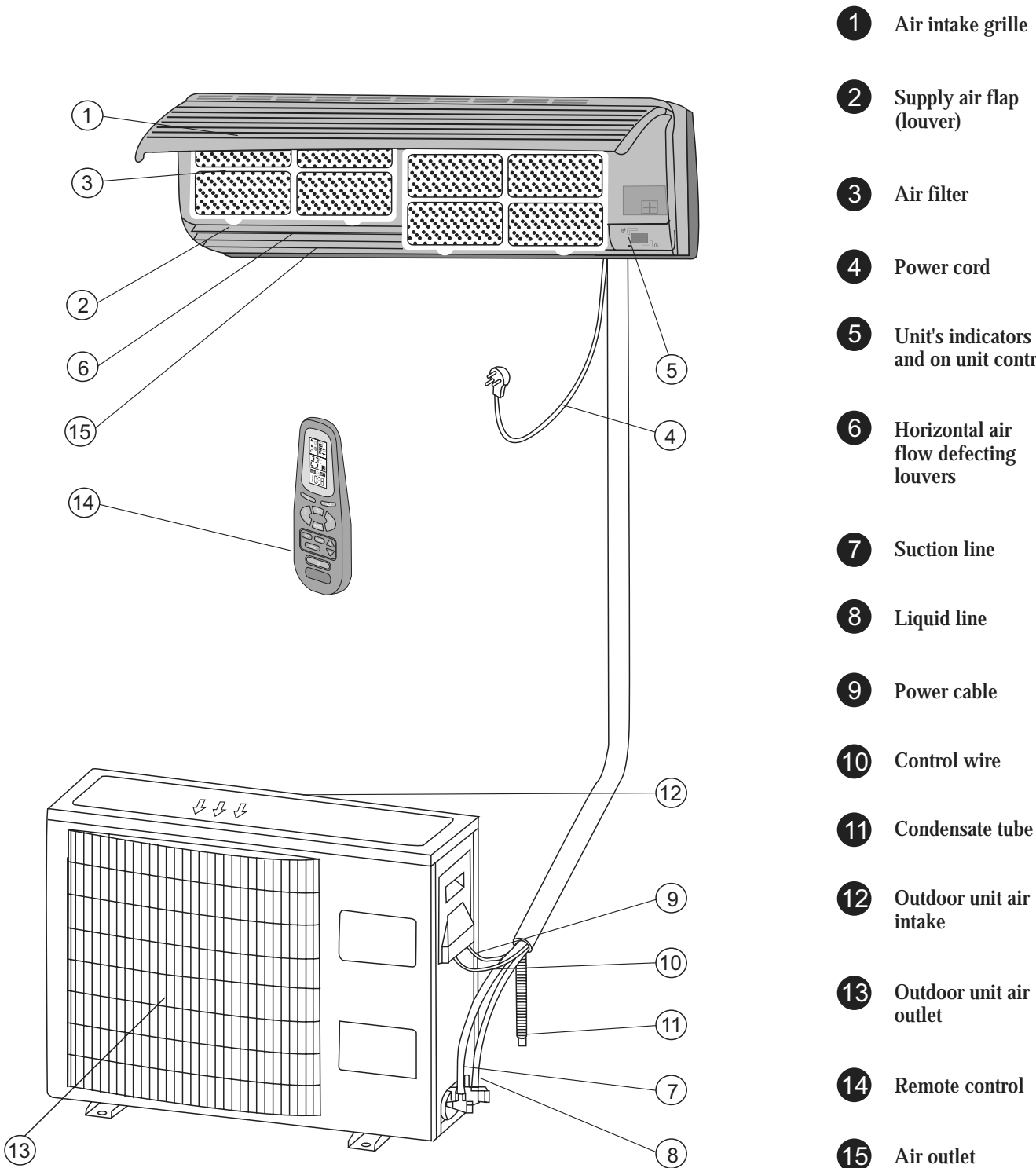

- 1 Air intake grille
- 2 Supply air flap (louver)
- 3 Air filter
- 4 Power cord
- 5 Unit's indicators and on unit control
- 6 Horizontal air flow deflecting louvers
- 7 Suction line
- 8 Liquid line
- 9 Power cable
- 10 Control wire
- 11 Condensate tube
- 12 Outdoor unit air intake
- 13 Outdoor unit air outlet
- 14 Remote control
- 15 Air outlet

OPERATION MODES, FUNCTIONS AND FEATURES



COOL Cools, dehumidifies and filters the room air. Maintains the desired room temperature.



HEAT Heats and filters the room air. Maintains the desired room temperature.



AUTO Automatically switches from COOLING to HEATING or from HEATING to COOLING, maintaining the desired temperature according to the room conditions.



DRY Dehumidifies and softly cools the room. In DRY Mode, the air conditioner operates at an increased dehumidifying power. This function is recommended to be used when temperature is rather low but the humidity is high.



FAN Recirculates and filters the room air. Maintains constant air movement in the room.



AUTO FAN The air conditioner automatically selects the FAN speed in accordance to with the room temperature. At the start, the unit operates at high fan speed. As the room air approaches to the desired temperature, the fan switches to a lower speed for quieter operation.

HOT KEEP In HEATING and in AUTO FAN, the fan will be turned off when the compressor is not in operation and will not be restarted, unless the indoor coil reaches adequate temperature. This HOT KEEP feature prevents uncomfortable cold air drafts. Use of AUTO FAN is, therefore, recommended when the air conditioner is in HEATING mode.



TIMER Real time control and display, automatically turns the air conditioner ON and OFF according to the time of day setting, ensuring comfort conditions before returning home, without wasting electricity. It turns the air conditioner off automatically when sleeping.



SLEEP Designed to create comfortable sleeping conditions. When in COOLING mode, the temperature rises one degree centigrade every hour, for to three hours, from the start of the mode. The temperature rise prevents the feeling of over-cooling while sleeping (when your body is at rest). In HEATING mode the reverse occurs; the air conditioner lowers its temperature one-degree every hour. When in SLEEP mode, the air conditioner will be automatically turned off after have operated for seven hours. The result is a more comfortable and invigorating sleep, which leaves you feeling fresh and energetic on the next morning.

**AUTO
LOUVRE**

The air louvers is automatically positioned for the most suitable blow-out angle, when COOL, HEAT, DRY or FAN modes are selected. When the air conditioner is turned off, the flap will close automatically for an aesthetic appearance.



**VERTICAL
AIR SWING**

Automatic swing of supply air in vertical direction. The flap moves automatically in upward and downward direction to spread the conditioned air evenly throughout the room.



BUZZER

A soft buzzer will sound from the indoor unit display to indicate that a command sent by the remote control has been accepted and stored in the unit's memory. This feature may be easily cancelled by the user from the display panel.

**ON UNIT
OPERATION**

The air conditioner can be turned ON for COOLING or HEATING or be turned OFF directly from the indoor unit display panel without the use of the remote control.

**3-MIN
DELAYED RUN**

This compressor is protected by a three-minute delayed restart.

USE OF WIRELESS REMOTE CONTROL

PRIOR TO OPERATION

Prior to operating your air conditioner, make sure that:

- The indoor unit is properly plugged into power. (Except for multi-split models).
- Indicator(A) on the unit's display is lit, meaning that the air conditioner is ready to accept your remote control commands.
- For clock setting, see page 11.

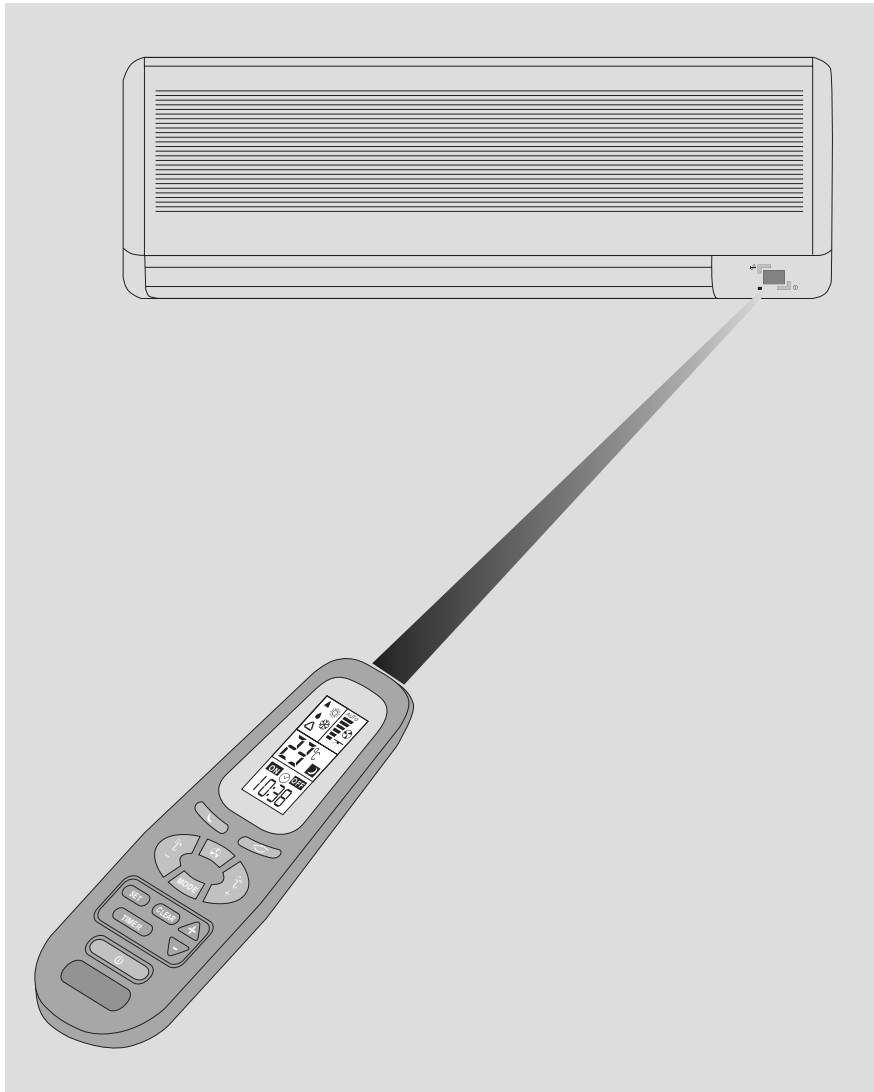

CARD TYPE REMOTE CONTROL PUTS ALL FUNCTIONS AT YOUR FINGERTIPS

- Aim at the infrared signal receiver on the room air conditioner when operating.
- The remote control signal can be received at a distance of up to about 7m.
- Be sure that there are no obstructions between the remote control and the signal receptor.
- Do not drop or throw the remote control.
- Do not place the remote control in a location exposed to direct sunlight, or next to a heating unit, and/or other heat source.
- Do not expose the air conditioner signal receiver(C) to a strong light such as fluorescent lamp or sunlight

ON-UNIT INDICATORS AND CONTROLS

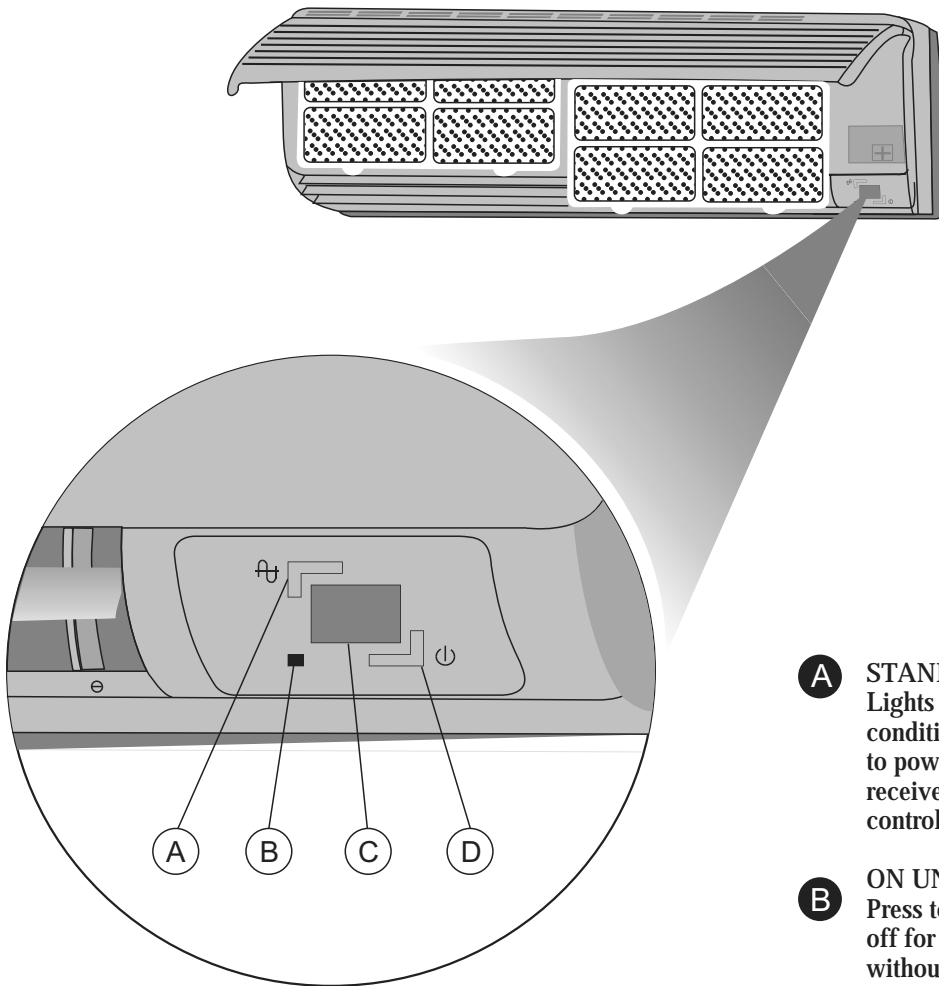

- A** **STAND-BY INDICATOR**
Lights up when the air conditioner is connected to power and ready to receive the remote control commands.
- B** **ON UNIT CONTROL**
Press to turn on or turn off for COOLING or HEATING without the use of remote control
- C** **SIGNAL RECEIVER**
Receive signals from the remote control.
- D** **OPERATION INDICATOR**
Lights up during operation. Blinks once to announce that the remote control infrared signal has been received and stored. Blinks continuously in protection mode.

REMOTE CONTROL

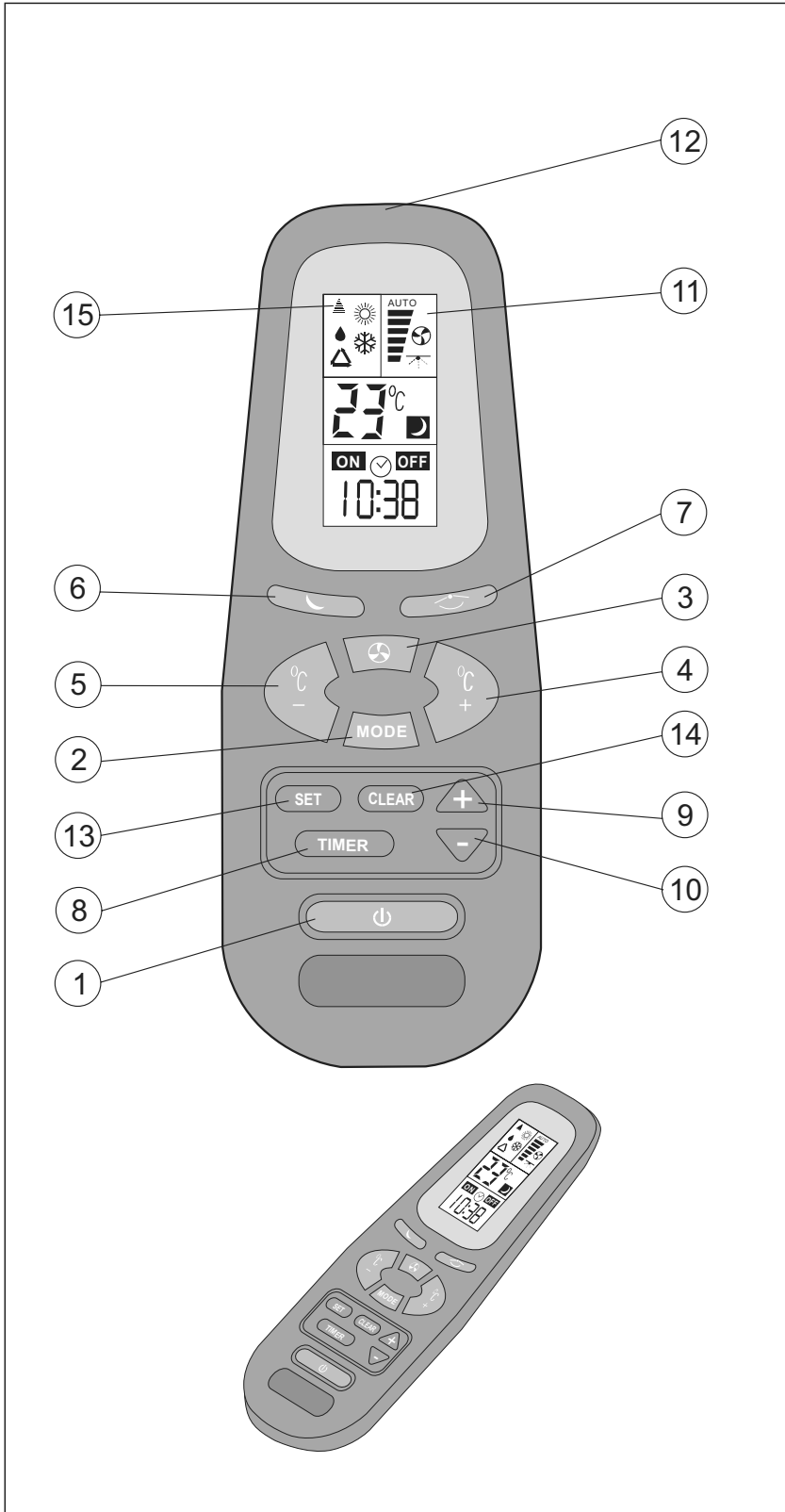

- ① START/STOP button
- ② Operation mode selection button
COOLING
HEATING
AUTO COOL/HEAT
DRY
FAN
- ③ FAN SPEED and AUTO FAN button
- ④ Room temperature UP button
- ⑤ Room temperature DOWN Button
- ⑥ SLEEP button
- ⑦ Airflow direction AUTO-CONTROL button
- ⑧ TIMER button
- ⑧ TIMER UP button
- ⑨ TIMER DOWN button
- ⑩ LCD operation display
- ⑪ Infrared signal transmitter
- ⑫ TIMER SET button
- ⑬ TIMER CLEAR button
- ⑭ Transmission sign
- ⑮

OPERATION PROCEDURE

TURNING ON THE AIR CONDITIONER

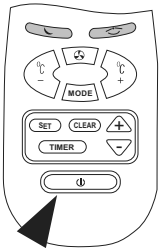

Press START/STOP button (1) to turn the air conditioner. After connecting to the power supply, The indicator (B) on the air conditioner light up, indicating that the air conditioner is in the standby status. Please note that LCD operation display (13) will always show the last mode of operation and the previous function used. If you want to change the control settings, proceed according to the following instructions. Otherwise, the air conditioner will start and operate in the same mode and functions prior to being turned off.



VENTILATING OPERATION

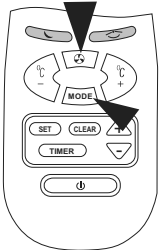

Select the ventilating mode by pressing MODE button (2). Switch to the desired fan speed by pressing FAN speed button (3).



COOLING OPERATION

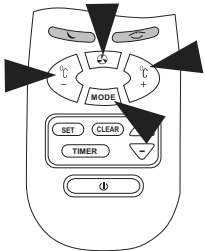

Select the COOLING mode by pressing MODE button (2). Switch to the desired FAN SPEED or to AUTO FAN by pressing button (3). Select suitable temperature setting. By selecting the COOLING mode, the air flap will move automatically to air delivery position, optimal for cooling.

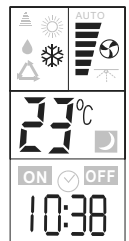

COOLING OPERATION WITH AUTO FAN MODE

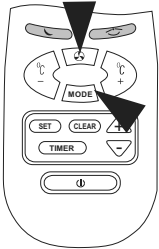

This operation starts with the highest air flow in order to quickly lower the room temperature. It will then automatically switch to the low air flow to quietly maintain the selected temperature.

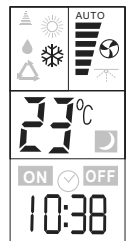

HEATING OPERATION

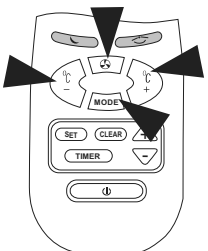

Select the HEATING mode by pressing MODE button (2). Switch to the desired FAN SPEED or to AUTO FAN by pressing FAN button (3). Select suitable temperature setting. By selecting the HEATING mode, the air flap will move automatically to air delivery position, optimal for heating.

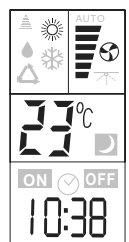

HEATING OPERATION WITH AUTO FAN MODE

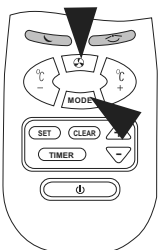

This operation starts with the highest air flow in order to quickly raise the room temperature. It will then automatically switch to a lower air flow to quietly maintain the selected temperature. HEATING with AUTO FAN will automatically provide the user with the HOT KEEP function. The fan will be turned off when the indoor coil temperature is not sufficiently hot to prevent uncomfortable cold air drafts.

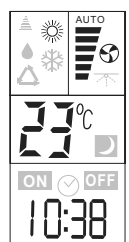

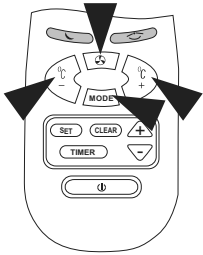

AUTO COOLING/HEATING OPERATION

Select the AUTO mode by pressing MODE button (2). Switch to the desired FAN SPEED or to AUTO FAN by pressing button (3). Select suitable temperature setting. The air flap will automatically move to either horizontal air delivery for cooling or to vertical air delivery for heating. At start, the air conditioner will select its mode of operation according to the room temperature and the temperature setting

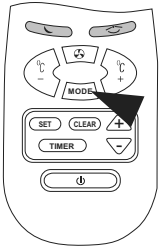

DRY OPERATION

Select the DRY mode by pressing MODE button (2). Select the suitable temperature setting. While in DRY mode, the air conditioner will operate at low fan speed, regardless of the fan setting on the LCD operation display. Fan might terminate operation from time to time to prevent from over cooling. By selecting the mode, the air flap will move automatically to optimal horizontal air delivery position.

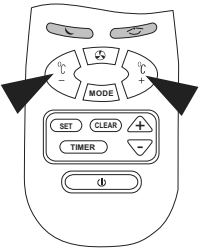
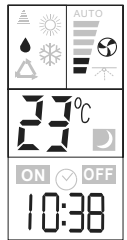

SELECTING THE TEMPERATURE

Press TEMP button (4) or (5) to change the temperature setting in the LCD operation display(11).The temperature setting is shown in degrees centigrade. A higher number indicates a higher room temperature. A lower number indicates a lower room temperature.

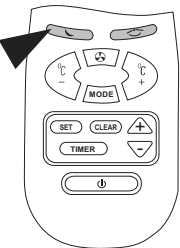

SLEEP FUNCTION

Press the SLEEP button (6) to select the SLEEP function. When the sleep function is activated the air conditioner will be automatically turned OFF after seven hours. If at the same time TIMER is activated, as well ,the air conditioner will be turned ON and OFF according to the TIMER setting.

To cancel the SLEEP function press on one of the following:

- START/STOP button (1)
- SLEEP button (6)

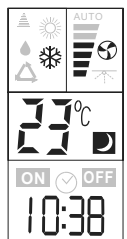

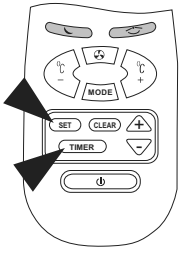

TIMER OPERATION

Press TIMER select button (8) to activate the timed operation mode. Each time you press TIMER button (8) is pressed, one of the following four type of operation modes will appear on the LCD display. The operation modes are sequenced in turn in the direction of arrow. Indicator (C) on the air conditioner will light up during TIMER operation.



Note: After power failure when the unit is in timer mode indicator (D) will be blinking and the unit will be automatically turned to stand-by mode and the timer operation will be cancelled. To resume the timer wait 30 sec. before reprogramming. Follow the instructions above.

TIMER OPERATING MODES

I. TIMER ON

This mode enables you to set a start operating time .Press the TIMER button (8) till ON sign blinks. Star time can be adjusted using up and down buttons (9) and (10) respectively. Press SET button (13) to activate the timer.

Example: Operation is restored at 10:30 a.m.

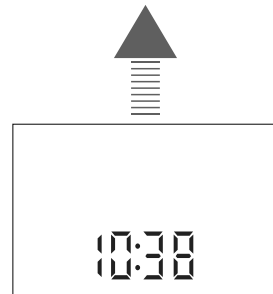
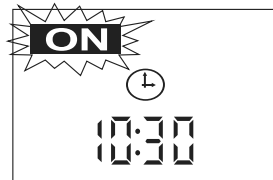

II. TIMER OFF

This mode enables you to set the stop time of operation. Press the Timer button (8) till the OFF sign blinks. Time can be adjusted using up and down buttons (9) and (10) respectively. Press Set button (13) to activate the timer.

Example: Operation stops at 18:00.

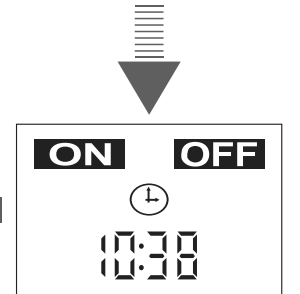
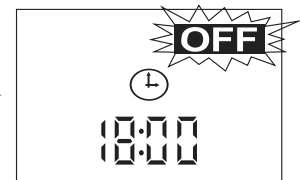

IV. CLEAR

Use this mode to cancel timer operation. Press CLEAR button (14), timer operation will terminate and the LCD display will be cleared for each timer mode.

Note: If timer button (8) is selected and neither time adjust, SET, or CLEAR buttons are not pressed within 15 seconds; the timer operation will be cancelled and the last setup will be displayed

III. TIMER ON/OFF

This mode enables you to set the start and stop time of operation. Press Timer button (8) till the ON sign blinks. By pressing again the OFF sign blinks. By press again the ON sign blinks. Time can be adjusted by using the up and down buttons (9) and (10) respectively. Press Set button (13) to activate the timer.

Example: Operation is restored at 10:30 a.m. Operation stops at 18:00

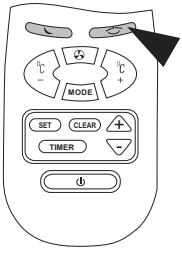

AUTOMATIC VERTICAL AIR SWING

Press button (7) to activate the auto air swing. By Pressing button (7) again you can stop the auto swing and position the air flap at any desired anle.

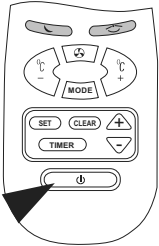
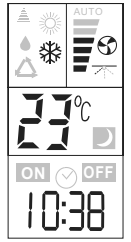

TURNING OFF THE AIR CONDITIONER

Press START/STOP button (1) to turn off the air conditioner. Indicator (B) on the air conditioner will be turned off. Indicator (A) will stay lit, indicating that the air conditioner is in STAND-BY mode and ready to accept any new command from the remote control. The remote control LCD will display the clock time. The last operating set-up will be kept for the next operation.

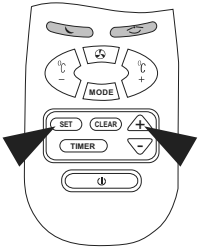
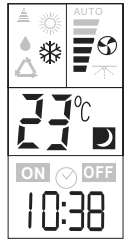

CURRENT CLOCK TIME SET

Clock setting is performed when batteries are inserted. The remote control displays the setting and the clock display will blink "0:00" or "12:00" AM (AM sign will blink, too) till a new time is set.

For clock setting, use buttons (9) and (10) for setting the hours and minutes, respectively, and then press timer SET button (13). The clock setting can be also performed by pressing time SET button (13) for 5 seconds.

The clock display will blink, for new setting follow the steps described above.

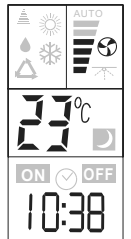

PROTECTION MODES

Your air conditioner includes several automatic protection modes, which enables you to use it virtually at any time and in any season, regardless of the outdoor temperature. Some of the protection modes are listed below:

Mode	Operation conditons	Protection from	Controlled remedy
Cooling	Low outdoor temperature	Indoor coil freezes up	Stops outdoor fan and compressor when approaching freezing conditions Resumes operation automatically.
	High outdoor temperature	Outdoor coil overheating	Stops compressor when approaching over heating conditions. Resumes operation automatically. Operating indicator(D) blinks.
Heating	Low outdoor temperature	Outdoor coil ice build up	Reverses Operation from heating to cooling for short periods to de-ice outdoor coil. Oiperating indicator (D) blinks.
	High indoor or outdoor temperature	Indoor coil overheating	Stops outdoor fan and compressor when approaching high indoor coil temperature. Resumes operation automatically.

CARE AND MAINTENANCE

Before performing any maintenance procedure, make sure to disconnect the air conditioner from the power.

CLEANING THE AIR FILTER

- To remove the air filters lift up the panel. Push the air filters up slightly to unlock them. Pull out the filters clean the filter by washing in warm soapy water and dry thoroughly. Align and fit the filters in place. Close the panel by pushing it in the center to lock it in place.

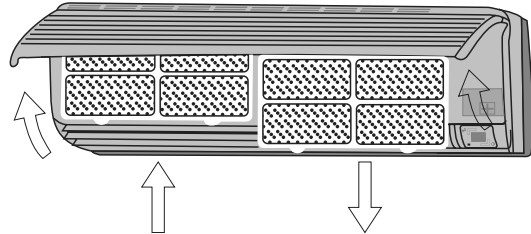

CLEANING THE AIR CONDITIONER

- Wipe the unit with a soft dry cloth or clean it using a vacuum cleaner.
- Do not use hot water or volatile materials which could damage the surface of the air conditioner.

AT THE BEGINNING OF THE SEASON

- Make sure there are no obstacles blocking the flow of inlet or outlet air, in both indoor and outdoor units.
- Make sure the power is properly connected.

PROTECT THE ELECTRONIC SYSTEM

- Indoor unit and remote control must be at least 1 meter away from a TV, radio or any other home electronic appliance.
- Protect the indoor unit from direct sun or lighting.

REMOTE CONTROL BATTERY CHANGE

- Remove the batteries from the remote control as shown.
- Use two 1.5 volt size AAA batteries



OPERATING TIPS

- Set a suitable room temperature; excessively low room temperature is not good for your health and wastes electricity. Avoid frequent setting of the temperature.
- During cooling, avoid direct sun. Keep curtains and blinds closed. Close doors and windows to keep the cool air in the room.
- Avoid generating heat or using of heating appliances while the air conditioner in cooling mode.
- Make sure that the air flap is positioned properly: horizontal flow in cooling and downward vertical flow for heating.
- Keep the room temperature uniform by adjusting the left/right vertical air blades.
- Position the air flap and the left/right air blades in such a manner as to prevent your body from being exposed directly to air drafts.
- During prolonged operation, ventilate the room occasionally by opening a window from time to time.
- In a power failure, the microprocessor memory is retained. When restarted, operation will be resumed in the last mode of operation.
- After turning on, allow more than 3 minutes for cooling, heating or dry operation to start.
- When COOL modes are used, make sure that the room's relative humidity is below 78%. If the unit is used for a prolonged periods of time in high humidity, moisture may form on the air outlet and drip down.
- Remote control signals may not be received if the indoor unit controls cover is exposed to direct sunlight or strong light. In such a case, block the sunlight or dim the lighting.
- The remote control is operative in a range of 7 meters. If you are out of range, the remote control may have difficulties in transmitting signals.

PRECAUTIONS

- Use the proper electrical fuse.

Do not pull out the power cord unless the unit is turned off.



- Do not start or stop operation by disconnecting the power cord.



- Do not obstruct or block the air inlet or air outlet of the air conditioner.

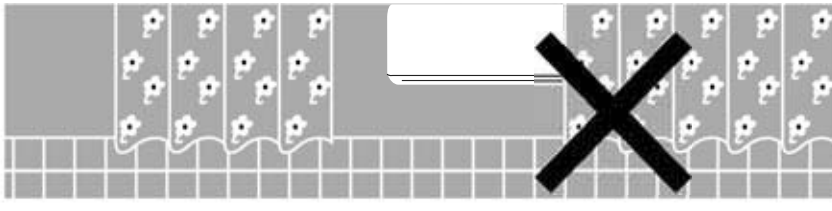

- Do not insert any objects in the air outlet of the indoor or outdoor units.



- Do not splash water on the air conditioner.

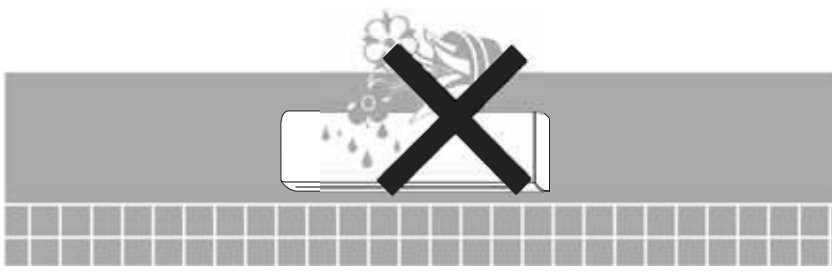

IF NOISE IS HEARD

There may be hissing sound during operation or just after shut down. This is caused by the refrigerant that is circulating inside the unit.

There may be a cracking sound at starting and stopping the unit's operation. This is caused by heat expansion or contraction of plastics.

BEFORE CALLING FOR SERVICE

Before calling for service, please check the following common malfunctions and correct it as needed.

Problem	Cause	Remedy
<ul style="list-style-type: none"> Unit does not operate. Stand-by indicator does not light up 	<ul style="list-style-type: none"> <input type="checkbox"/> Unit not connected to power <input type="checkbox"/> Power failure 	<ul style="list-style-type: none"> ■ Plug in the power cord ■ Check main fuse
<ul style="list-style-type: none"> unit does not operate. Stand-by indicator lights. 	<ul style="list-style-type: none"> <input type="checkbox"/> Remote control malfunctions 	<ul style="list-style-type: none"> ■ Check remote control batteries ■ Try to operate from a closer distance ■ Start from on-unit controls
<ul style="list-style-type: none"> Unit does not respond properly to remote control command 	<ul style="list-style-type: none"> <input type="checkbox"/> IR signal does not reach unit <input type="checkbox"/> Distance between remote control and unit too large or aimed at from improper angle <input type="checkbox"/> IR receiver on-unit exposed to strong light source 	<ul style="list-style-type: none"> ■ Check for obstruction between unit and remote control. Clear if needed. ■ Get closer to unit ■ Dim lights, fluorescents especially
<ul style="list-style-type: none"> Air does not blow out from indoor unit 	<ul style="list-style-type: none"> <input type="checkbox"/> De-icing protection mode is activated 	<ul style="list-style-type: none"> ■ Normal operation in HEATING mode
<ul style="list-style-type: none"> COOLING, or HEATING does not start immediately 	<ul style="list-style-type: none"> <input type="checkbox"/> 3-min. compressor delayed start 	<ul style="list-style-type: none"> ■ Normal operation for these modes
<ul style="list-style-type: none"> Unit functions but does not perform sufficiently 	<ul style="list-style-type: none"> <input type="checkbox"/> Improper temperature setting <input type="checkbox"/> Unit capacity insufficient for load or room size 	<ul style="list-style-type: none"> ■ Rreset temperature ■ Consult your dealer







INSTALLATION INSTRUCTIONS

1. ACCESSORIES SUPPLIED WITH AIR CONDITIONER
2. LOCATION OF INDOOR AND OUTDOOR UNITS
3. ELECTRICAL REQUIREMENTS
4. INSTALLATION OF THE INDOOR UNIT
5. CONDENSATE HOSE CONNECTION
6. ELECTRICAL CONNECTIONS BETWEEN INDOOR AND OUTDOOR UNITS
7. REFRIGERANT TUBING
8. FINAL TASKS

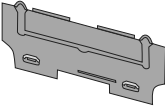
The appliance shall not be installed in the laundry.

INSTALLATION INSTRUCTIONS FOR SPLIT WALL MOUNTED AIR CONDITIONER

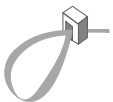
1 ACCESSORIES SUPPLIED WITH THE AIR CONDITIONER

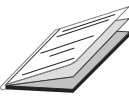
Shape	Name	Qty	Used for
	Mounting Plate	1	Wall mounting of the indoor unit
	Remote control With batteries	1	Operation of Unit
	Screws washers dowels	4	Wall mounting of indoor unit
	Outdoor unit drain connector	1	Outdoor unit water drain
	Mounting pads	4	Padding of outdoor unit bottom support
	Cable ties	4	Securing wires in the indoor and outdoor unit
	Cable terminals	1	Securing of grounding wire on the indoor and outdoor unit
	Twin wire cable (for heat pump units)	1	Transmitting signals
	Operation and installation instructions	1	Users and installers reference

2 LOCATION OF INDOOR AND OUTDOOR UNITS

Select the location considering the following:

INDOOR UNIT

1. Choose a location which will provide good air circulation. ensure that no objects or furnishings prevent air circulation.
2. Do not install the unit near a heat source or where it will be exposed to direct sunlight.
3. The location must allow convenient electrical draingage and tubing connections.
4. Installation site should provide an easy passage to outdoors.
5. The unit must be mounted on a strong wall that will withstand the generated vibrations.
6. Install the mounting plate as shown.

OUTDOOR UNIT

1. The location must allow easy servicing and provide good air circulation.
2. The unit may be suspended from a wall by a bracket (Optional) or located in a free standing position on the floor (preferably slightly elevated).
3. if the unit is suspended, ensure that the bracket is firmly connected and the wall is strong enough to withstand vibrations.
4. Unit location should not disturb neighbors with noise or exhaust air stream.
5. Place the mounting pads under the unit legs.
6. Install the outdoor unit as shown. Refer to the technical and service manual for allowed distances.
7. When the unit is installed on a wall, install the drain connector hose and drain plug as shown.

Fig.1

1. Bottom of outdoor unit
2. Drain connector

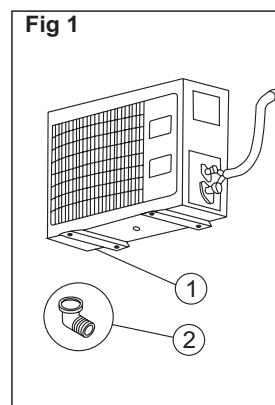

Fig.2

1. Drain installation
2. Example

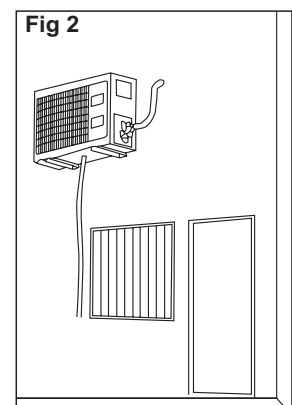

Fig.3
Length of electric cable to mains

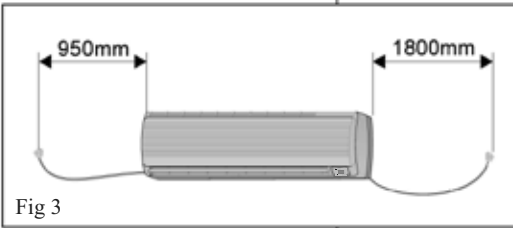

Fig.4
Direction of tubing

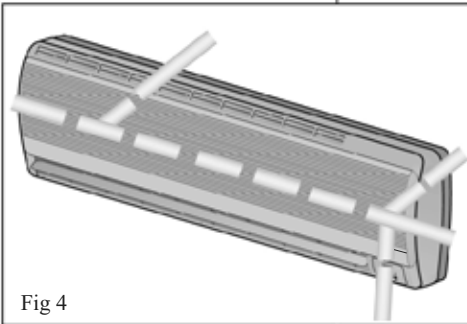

Fig 4

Fig.5

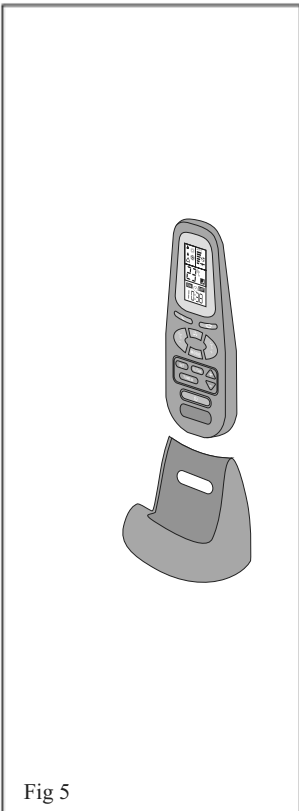

Fig 5

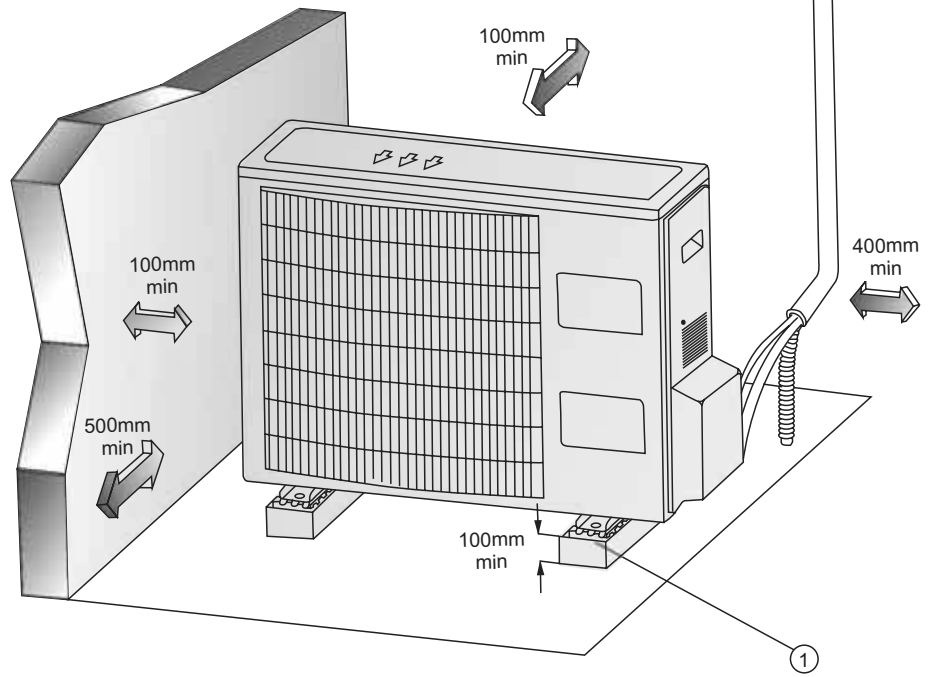
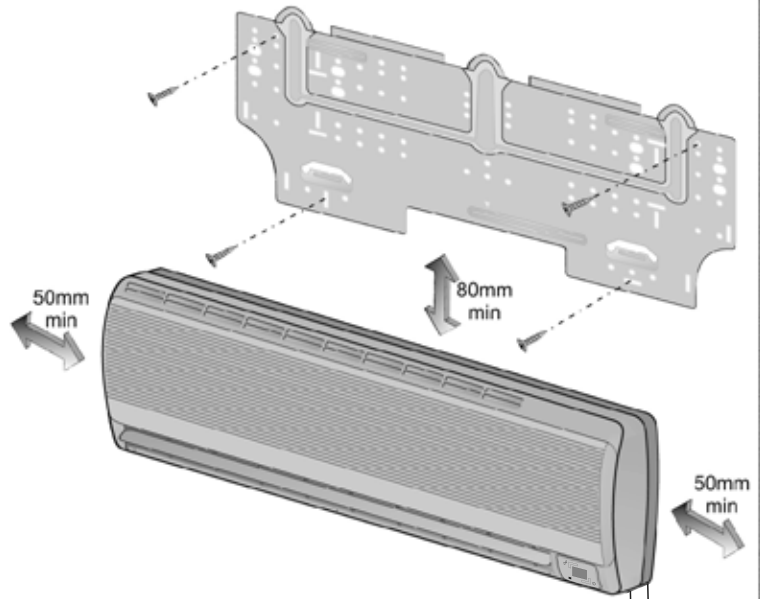

Fig.6
1.Mounting pads(x4)

Fig 6

3

ELECTRICAL REQUIREMENTS

Electrical wiring and connections should be made by qualified electricians and in accordance with local electrical codes and regulations. The air conditioner units must be grounded.

The air conditioner unit must be connected to an adequate power outlet from a separate branch circuit protected by a time delay circuit breaker, as specified on unit's nameplate.

Voltage should not vary beyond $\pm 10\%$ of the rated voltage.

4

INSTALLATION OF THE INDOOR UNIT

REMOVAL AND INSTALLATION OF THE FRONT PANEL

1. Open the front panel.
2. Place the horizontal deflection louvers in a horizontal position.
3. Open the screw caps on the panel front.
4. Unscrew the screws to release the front panel.
5. Remove the front panel by lifting it in the direction indicated by arrows.
6. After installation of the indoor unit, reinstall the front panel. Place the top end of the panel onto the top end of the indoor unit, press on the upper part of the panel, and at the same time push the bottom toward the indoor unit.
7. Replace the screw and their caps.

Fig.7

1. Lift front panel
2. Screw caps
3. Screw
4. Horizontal deflection levers
5. Screws
6. Front panel

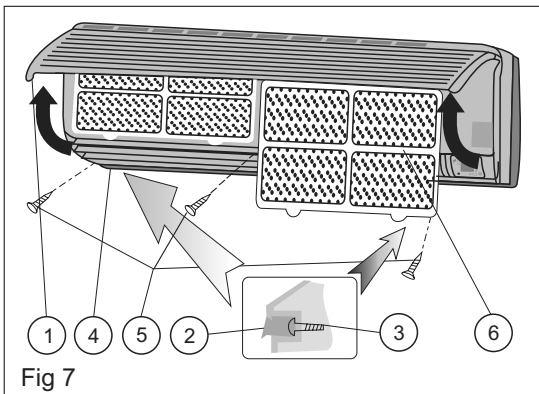

REFRIGERATION TUBE ROUTING

1. There are five possible routes for installing the refrigeration tube as shown.
2. For route (6), cut the bottom notch in the rear.
3. For routes (5) or (7), cut the side notches in the rear and in the front panel.

Fig.8

1. Front
2. Rear
3. Rear outlet
4. Lefthand outlet
5. Lefthand rar outlet
6. Bottom outlet
7. Righthand outlet

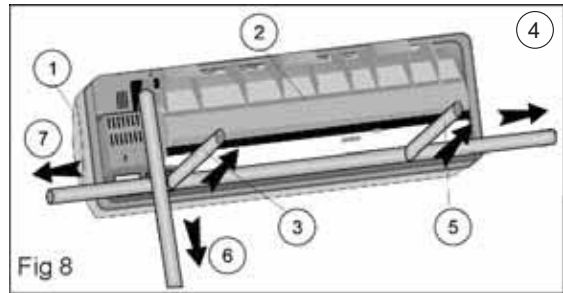

INSTALLATION OF THE MOUNTING PLATE

1. Figure 9 shows the location of the mounting plate relative to the unit size. Refer to one of the drawings, according to your unit length (marked in square).
2. Locate the mounting plate as shown on the wall in a horizontal position, using a spirit level.
3. Mark the position of the four mounting holes on the wall and drill four holes to accommodate the dowels.
4. Mount the mounting plate on to the wall by the four screws. Ensure screws are tightened properly.

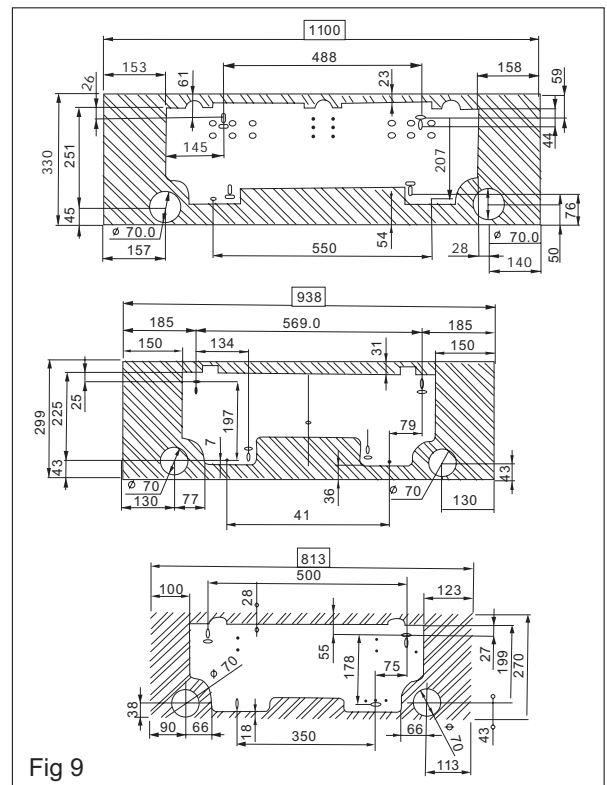

Fig 9

PENETRATION OF WALL FOR TUBING

1. Mark the location of the hole on either side of the mounting plate as shown. and drill it at a 5° downward angle, as shown.
2. The hole is drilled at an angle, to prevent condensed or rain water from penetrating back into the room
3. Trim the hole in the wall with a ϕ 70 mm commercial plastic tube.

Fig. 10

- A. OUTDOOR SIDE 1. Drill 70 mm
B. INDOOR SIDE 2. Wall

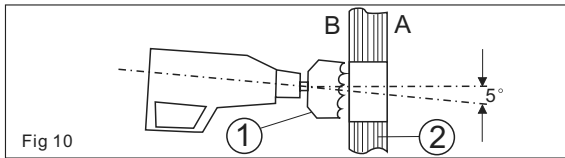

SUSPENDING AND RELEASING THE UNIT FROM THE MOUNTING PLATE

1. Make sure that the refrigerant tubes, electric cables and condensate water hose are well insulated with closed cell rubber based insulating tubes (6 mm thickness), are wrapped together with UV stabilized non-adhesive plastic tape, and are passed through the hole in the wall.
2. Hang the indoor unit on the two hooks that are located near the top edge of the mounting plate.
3. Press the lower part of the indoor unit against the mounting plate until the catches snap into the slots and lock the indoor unit to the mounting plate.
4. Check the installation by pulling the unit towards you.
5. To release the unit from the mounting plate, lift up the unit and then pull the unit towards you, to ensure that the hooks are locked.

Fig. 11

1. Indoor unit 3. Top hooks
2. Snap catches 4. Bottom hooks

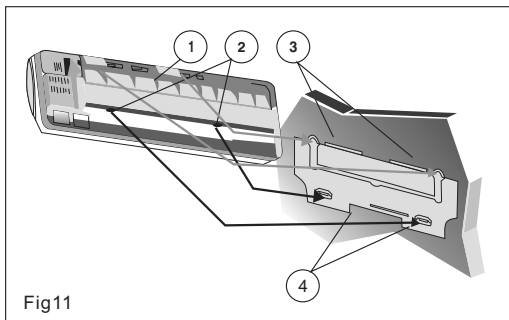
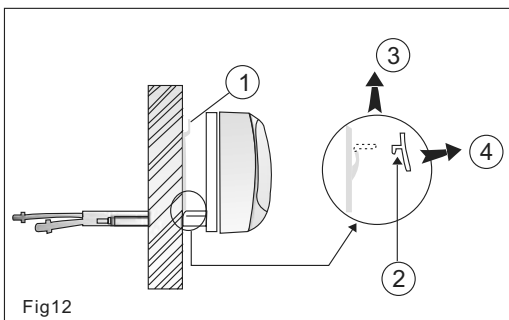

Fig. 12

1. Mounting plate 3. Lift up
2. Lower hook 4. Pull



5

CONDENSATE HOSE CONNECTION

1. Attach the condensate drain hose to the corrugated hose in the rear groove of the indoor unit.

Fig. 13

1. drain hose
2. Clamp
3. Downward slope

2. Wrap the drain hose together with the refrigerant tubes and electrical cables.

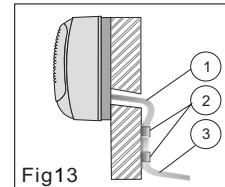

3. Ensure that the condensate drain hose is at all points installed in a downward slope manner.

Fig. 13

Fig. 14

1. Trap
2. U-bend
3. End immersed in water

4. When installing the drain hose avoid traps and U-bends. The end of the drain hose should not be immersed in water.

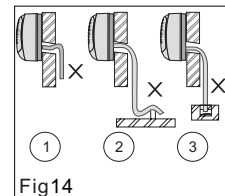

Fig. 14

Fig. 15

1. Electric cable
2. Refrigerant tubing
3. Condensate drain hose

5. For a lefthand outlet, lay the drain hose on the bottom of the indoor unit rear groove.

Fig. 15

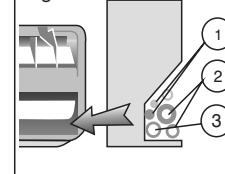

Fig. 16

1. Vent
2. Downward drain
3. Water drain hose

6. When the installation location requires long horizontal sections, a vent must be provided at the top of the hose to prevent overflow of the unit drain pan.

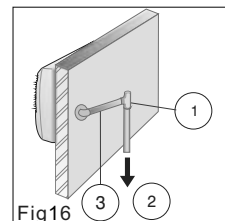

Fig. 16

Upon completing the installation, test the water drain by pouring at least two liters of water into the unit drainpan. Check that the water drains off.

6

ELECTRICAL CONNECTIONS BETWEEN INDOOR AND OUTDOOR UNITS

1. To connect the indoor unit to the outdoor unit use the following electrical cables, protected for outdoor use:

Cooling and heating model:

Multiple wire cable

5 wires x 1.5 mm²

5 wires x 0.5 mm² - for low voltage

(supplied with the unit).

Cooling only models:

Multiple wire cable

4 wires x 1.5 mm²

2. Prepare the multiple wire(7)cable ends for connection as shown in fig. 18.
3. Connect the cable ends to the terminals of the indoor and outdoor units, as shown in fig.20.
4. Shape a loop and connect the yellow/green ground wire (2) to ground terminal screw of the indoor unit, as shown in fig.20a.
5. Prepare the twin wire cable end for connection as shown in fig.19.
6. Disconnect the resistor (5) from the indoor unit twin wire cable (3) and connect the twin wire cable (6) connector instead.
7. connect the other end of the twin wire cable (6) to the outdoor unit twin wire terminal (9).
8. Secure the multiple wire power cable with the cable clamps.
9. Fasten the twin wire cable to the power cable with cable ties.

Fig.17

- 1.Terminal 2.Cover 3.Cable tie

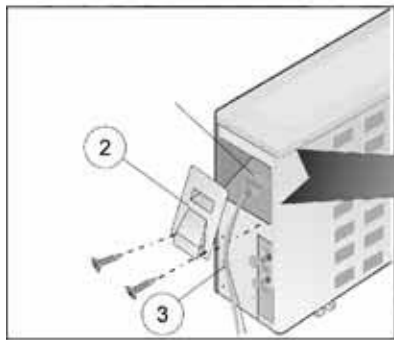

NOTES:

1. The wire color code can be selected by the installer.
2. Wires leading to outdoor unit twin wire terminal (9). must be in a separate twin wire cable, otherwise the electronic controls will be subjected to operational malfunctions.
3. For cooling only model, terminal number 5 should not be connected.

MULTIPLE WIRE POWER CABLE

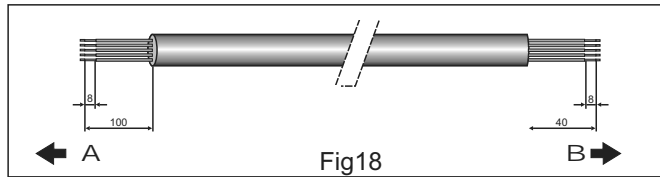

Fig.18 A.OUTDOOR B.INDOOR

TWIN-WIRE LOW VOLTAGE CABLE

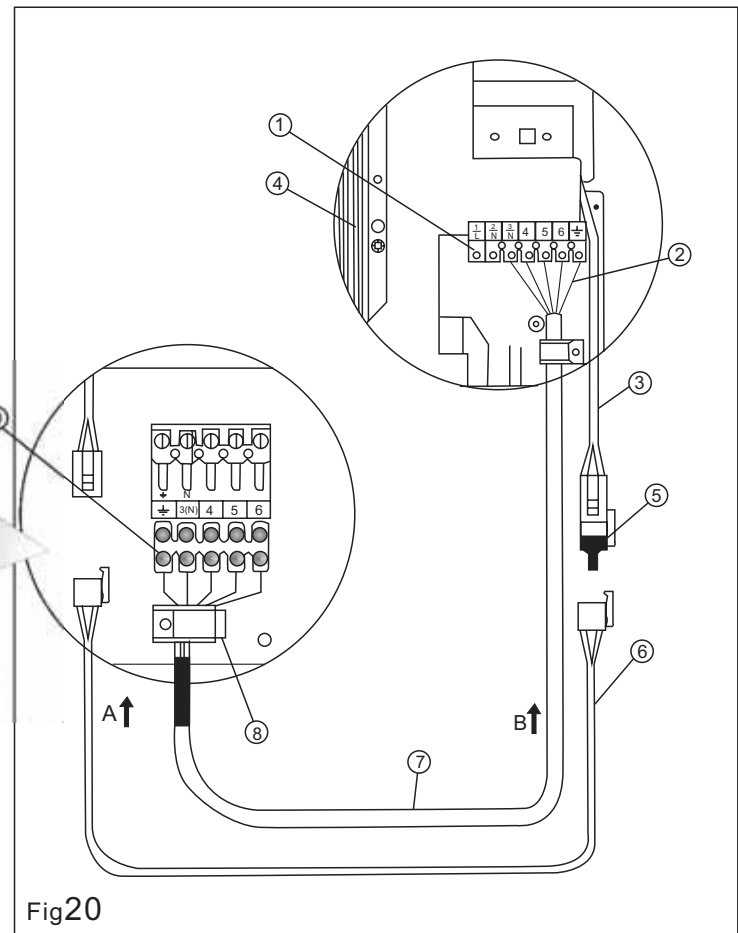
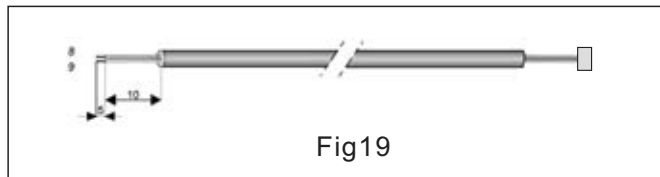

Fig.20

- 1.Indoor unit terminal
 2.Ground wire
 3.Indoor twin wire cable
 4.Indoor coil
 5.Resistor
 6.Twin wire cable
 7.Multiple wire cable
 8.Cable clamp
 9.Outdoor twin wire terminal
 A.OUTDOOR B.INDOOR

7 REFRIGERANT TUBING

CONNECT THE INDOOR TO THE OUTDOOR UNIT

The indoor unit contains a small quantity of refrigerant. Do not unscrew the nuts from the unit until you are ready to connect the tubing. The outdoor unit is supplied with sufficient refrigerant charge. Refer to outdoor unit nameplate.

To prevent crushing, bend tubes using a bending tool.

NOTE: Use refrigeration type copper tubing only.

1. Use tubing diameter that corresponds to the tubing diameter of the indoor and outdoor units. Note that the liquid and suction tubes have different diameters. (See tube size, torque tightening table.)
2. Place flare nuts on tube ends before preparing them with a flaring tool. Use the flare nuts that are mounted on the supplied outdoor and indoor units.
3. Connect the four ends of the tubing to the indoor and outdoor units.
4. Insulate each tube separately, and their unions, with at least 6 mm. of insulation. Wrap the refrigerant tubing, drain hose and electric cables together with a vinyl tape (UV protected).

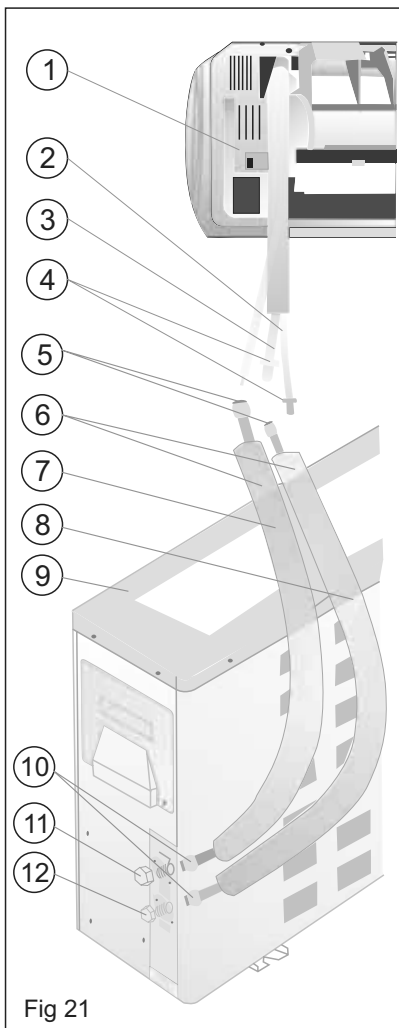

Caution!
When unscrewing the valve caps, do not stand in front of them or the spindles at any time, as the system is under pressure.

Fig.21
1. INDOOR UNIT
2. Liquid tube (small dia.)
3. Suction tube (large dia.)
4. Plugs
5. Flare nuts
6. Tubing between units
7. Suction tube
8. Liquid tube
9. OUTDOOR UNIT
10. Flare nuts
11. Suction valve (larger)
12. Liquid valve (small)

Tightening torques of unions and valve caps:

TUBE SIZE	TORQUE
Liquid line 1/4"	15-20 N.M.
Suction line 3/8"	30-35 N.M.
Suction line 1/2"	50-54 N.M.
Suction line 5/8"	75-78 N.M.

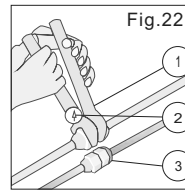

Fig.22
1. Wrench
2. Torque wrench
3. Union

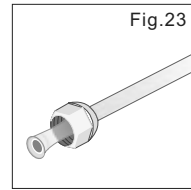

Fig.23
To prevent refrigerant leakage, coat the flared surface with refrigeration oil

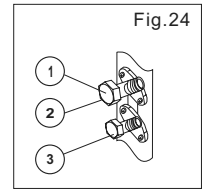

Fig.24
1. Suction valve
2. Service port
3. Liquid valve

EVACUATION OF THE REFRIGERATION TUBES AND THE INDOOR UNIT

After connecting the unions of the indoor and outdoor units, purge the air from the tubes and indoor unit as follows:

1. Connect the charging hoses with a push pin to the low and high sides of the charging set and the service port of the suction and liquid valves. Be sure to connect the end of the charging hose with the push pin to the service port.
2. Connect the center hose of the charging set to a vacuum pump
3. Turn on the power switch of the vacuum pump and make sure that the needle in the gauge moves from 0MPa(0cm Hg) to -0.1 MPa (-76cm Hg). Let the pump run for fifteen minutes.
4. Close the valves of both the low and high sides of the charging set and turn off the vacuum pump. Note that the needle in the gauge should not move after approximately five minutes.
5. Disconnect the charging hose from the vacuum pump and from the service ports of the suction and liquid valves.
6. Tighten the service port caps of both suction and liquid valves.
7. Remove the valve caps from both valves, and open them using a hexagonal Allen wrench.
8. Remount valve caps onto both of the valves.
9. Check for gas leaks from the four unions and from the valve caps. Test with electronic leak detector or with a sponge immersed in soapy water for bubbles.

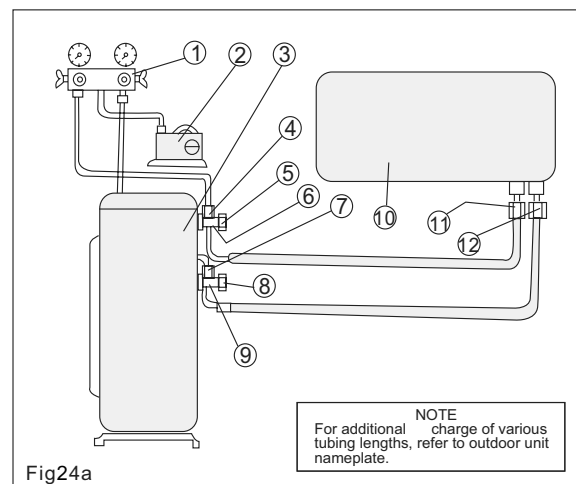

Fig.24a
1. Charging set
2. Vacuum pump
3. OUTDOOR UNIT
4. Service valve
5. Cap
6. Suction valve
7. Service valve*
8. Cap
9. Liquid valve
10. INDOOR UNIT
11. Suction flare connection
12. Liquid flare connection
*In some models only

NOTE
For additional charge of various tubing lengths, refer to outdoor unit nameplate.

8

FINAL TASKS

1. Replace all valve caps and ensure that they are tightened properly.
2. Fill gaps on the wall between hole sides and tubing with sealer.
3. Attach wiring and tubing to the wall with clamps where necessary.
4. Operate the air conditioner together with the customer and explain all functions.
5. Explain filter removal, cleaning and installation.
6. Give the operating and installation manuals to the customer.

AIR CONDITIONER SPLIT WALL MOUNTED

ENGLISH

CLIMATISEUR SPLIT MURAL

FRANÇAIS

CLIMATIZADOR SPLIT MURAL

ESPAÑOL

CONDIZIONATORE D'ARIA A PARETE SPLIT

ITALIANO

KLIMAGERÄT IN SPLIT BAUWEISE

DEUTSCH

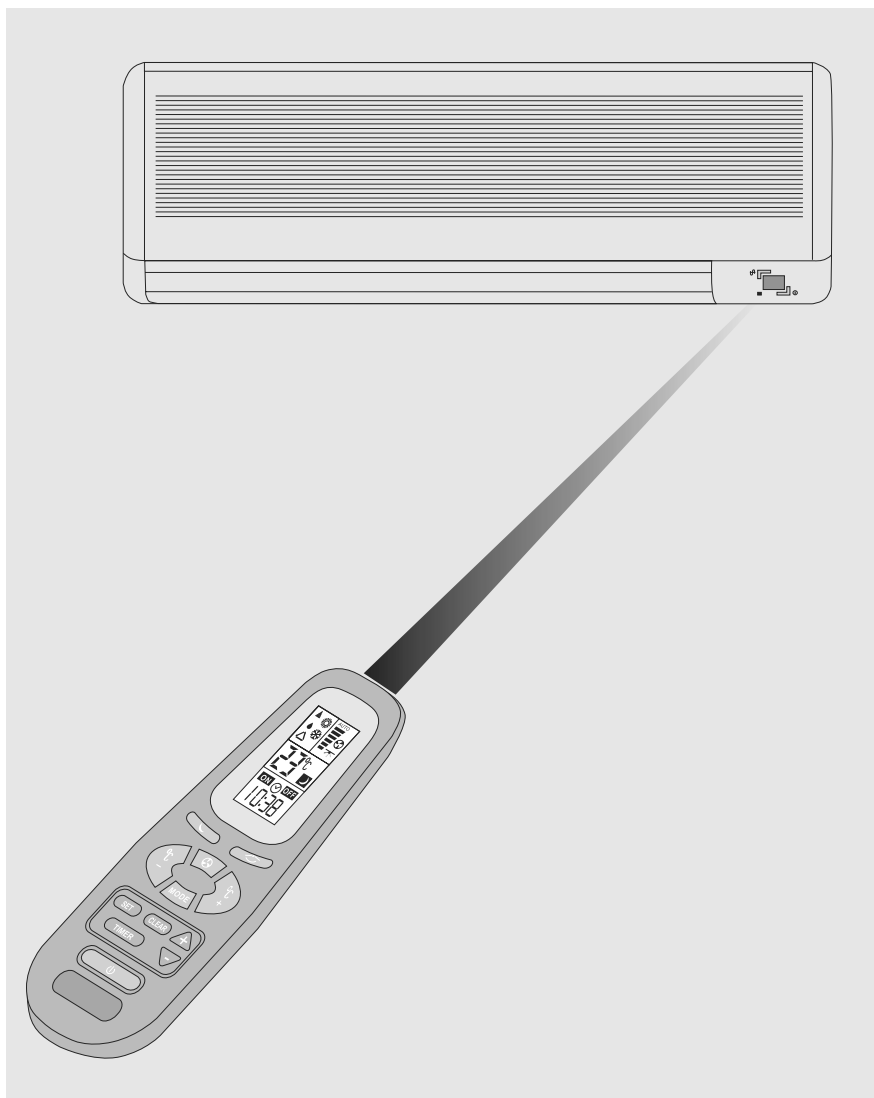

**PROGRAMMING AND OPERATING MANUAL
MANUEL D'UTILISATION ET DE PROGRAMMATION
MANUAL DE UTILIZACION Y DE PROGRAMACION
MANUALE DI UTILIZZO E DI PROGRAMMAZIONE
BEDIENUNGS UND PROGRAMMIERUNGS HANDBUCH**

ENGLISH

FRANÇAIS

ESPAÑOL

ITALIANO

DEUTSCH

**AIR CONDITIONER
SPLIT WALL MOUNTED
PROGRAMMING
AND OPERATING**

ENGLISH

CONTENTS

INTRODUCTION	1
SYSTEM DESCRIPTION	2
OPERATION MODES, FUNCTIONS AND FEATURES	3
USE OF WIRELESS REMOTE CONTROL	5
ON-UNIT INDICATORS AND CONTROLS	6
REMOTE CONTROL	7
OPERATION PROCEDURE	8
• Turning on the air conditioner	8
• Ventilating operation	8
• Cooling operation	8
• Cooling operation with auto fan mode	8
• Heating operation	8
• Heating operation with auto fan mode	8
• Auto cooling / heating operation	9
• Dry operation	9
• Selecting the temperature	9
• Sleep function	9
• Timer operation	10
• Automatic vertical air swing	11
• Turning off the air conditioner	11
• Current clock time set	11
PROTECTION MODES	12
CARE AND MAINTENANCE	13
OPERATING TIPS	14
PRECAUTIONS	15
BEFORE CALLING FOR SERVICE	16

*IF YOUR AIR
CONDITIONER IS FOR
COOLING ONLY, PLEASE
DISREGARD THE
HEATING INSTRUCTIONS*

*PLEASE READ THESE
INSTRUCTIONS BEFORE
OPERATING THE AIR
CONDITIONER*

INTRODUCTION

This Split Air Conditioner is designed for versatile applications:



- Cooling air in the summer.



- Dehumidifying the air at high humidity conditions.



- Heating.



- Ventilation.
-



OPERATING TEMPERATURE RANGE:
(According to T_i temperature condition)

Cooling: 21° ~ 43° C

Heating: -7° ~ 21° C

IMPORTANT NOTICE:

- This air conditioner must be grounded to protect against electrical shock.

- Installation of the air conditioner must be performed by an experienced air conditioning installer, observing good refrigeration practice.

- Electrical connections and power cord replacement should only be made by authorized electricians and in accordance with electrical regulations and local codes.

- Failure to comply with the manufacturer's installation and operation instructions could affect the performance of the air conditioner and the validity of the warranty.

SYSTEM DESCRIPTION

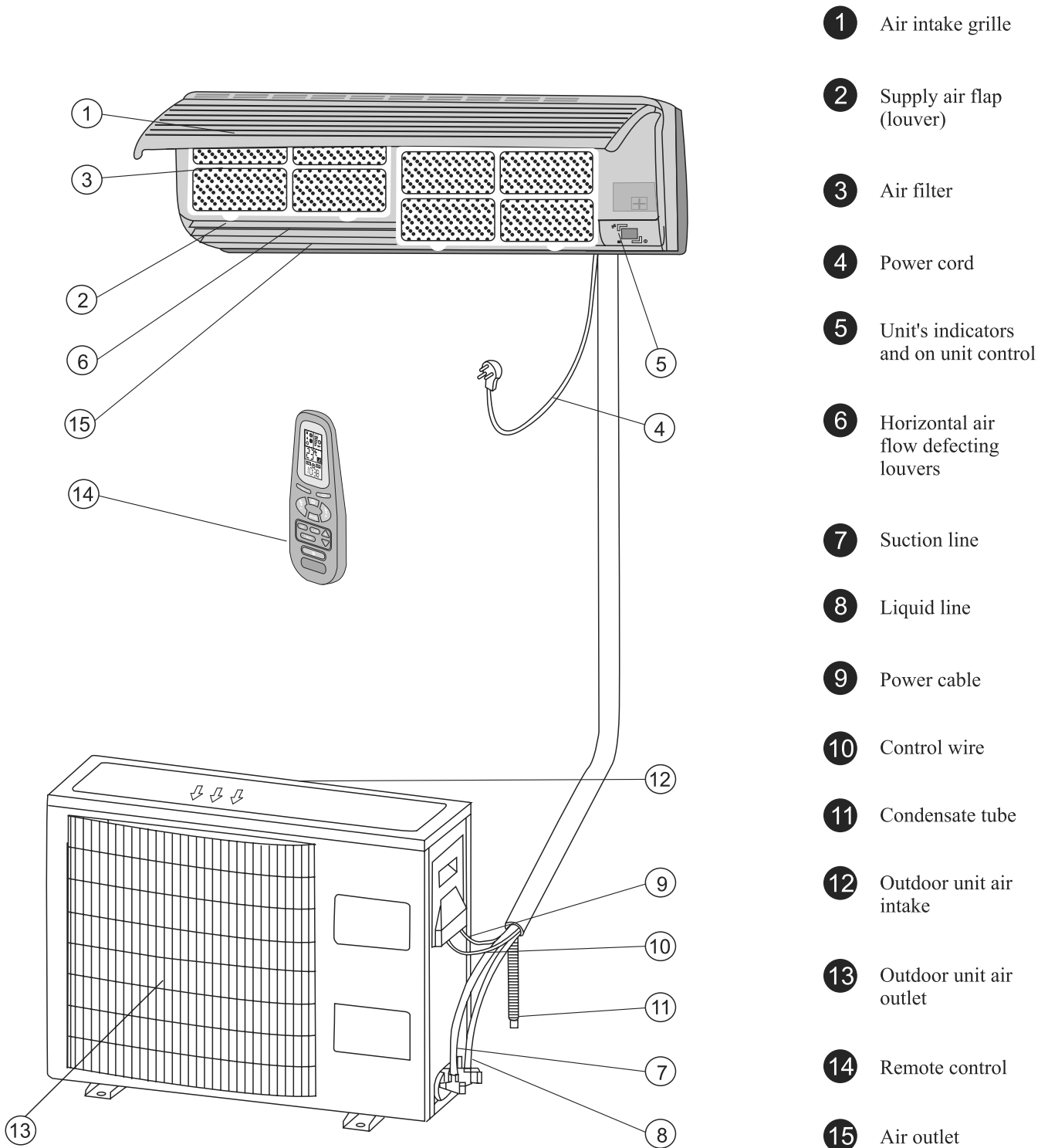

- ① Air intake grille
- ② Supply air flap (louver)
- ③ Air filter
- ④ Power cord
- ⑤ Unit's indicators and on unit control
- ⑥ Horizontal air flow deflecting louvers
- ⑦ Suction line
- ⑧ Liquid line
- ⑨ Power cable
- ⑩ Control wire
- ⑪ Condensate tube
- ⑫ Outdoor unit air intake
- ⑬ Outdoor unit air outlet
- ⑭ Remote control
- ⑮ Air outlet

OPERATION MODES, FUNCTIONS AND FEATURES



COOL Cools, dehumidifies and filters the room air. Maintains the desired room temperature.



HEAT Heats and filters the room air. Maintains the desired room temperature.



AUTO Automatically choose COOLING or HEATING or DRY, maintaining the desired temperature according to the room conditions.



DRY Dehumidifies and softly cools the room. In DRY Mode, the air conditioner operates at an increased dehumidifying power. This function is recommended to be used when temperature is rather low but the humidity is high.



FAN Recirculates and filters the room air. Maintains constant air movement in the room.



AUTO FAN The air conditioner automatically selects the FAN speed according to the request temperature. At the start, the unit operates at high fan speed. As the room air approaches to the desired temperature, the fan switches to a lower speed for quieter operation.



HOT KEEP In HEATING and in AUTO FAN, the fan will be turned off when the compressor is not in operation and will not be restarted, unless the indoor coil reaches adequate temperature. This HOT KEEP feature prevents uncomfortable cold air drafts. Use of AUTO FAN is, therefore, recommended when the air conditioner is in HEATING mode.



TIMER Real time control and display, automatically turns the air conditioner ON and OFF according to the time of day setting, ensuring comfort conditions before returning home, without wasting electricity. It turns the air conditioner off automatically when sleeping.



SLEEP Designed to create comfortable sleeping conditions. When in COOLING mode, the temperature rises one degree centigrade after each consecutive hour, up to three hours, from the start of the mode. The temperature rise prevents the feeling of over-cooling while sleeping (when your is at rest). In HEATING mode the reverse occurs; the air conditioner lowers its temperature one degree every hour, up to three hours, from the start of the mode. When in SLEEP mode, the air conditioner will be automatically turned off after have operated for seven hours. The result is a more comfortable and invigorating sleep, which leaves you feeling fresh and energetic in the morning.

AUTO LOUVRE	The air louvers is automatically positioned for the most suitable blow-out angle, when COOL, HEAT, DRY or FAN modes are selected. When the air conditioner is turned off, the flap will close automatically for an aesthetic appearance.
 VERTICAL AIR SWING	Automatic swing of supply air in vertical direction. The flap moves automatically in upward and downward direction to spread the conditioned air evenly throughout the room.
 BUZZER	A soft buzzer will sound from the indoor unit display to indicate that a command sent by the remote control has been accepted and stored in the unit's memory. This feature may be easily cancelled by the user from the display panel.
ON UNIT OPERATION	The air conditioner can be turned ON for COOLING or HEATING or be turned OFF directly from the indoor unit display panel without the use of the remote control.
3-MIN DELAYED RUN	This compressor is protected by a three-minute delayed restart.

USE OF WIRELESS REMOTE CONTROL

PRIOR TO OPERATION

Prior to operating your air conditioner, make sure that:

- *The indoor unit is properly plugged into power. (Except for multi-split models).*
- *Indicator(A) on the unit's display is lit, meaning that the air conditioner is ready to accept your remote control commands.*
- *For clock setting, see page 11.*

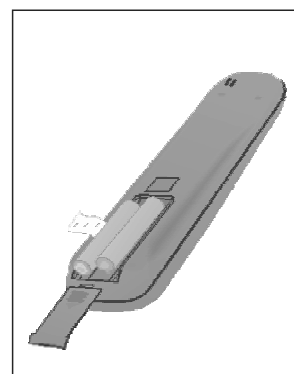
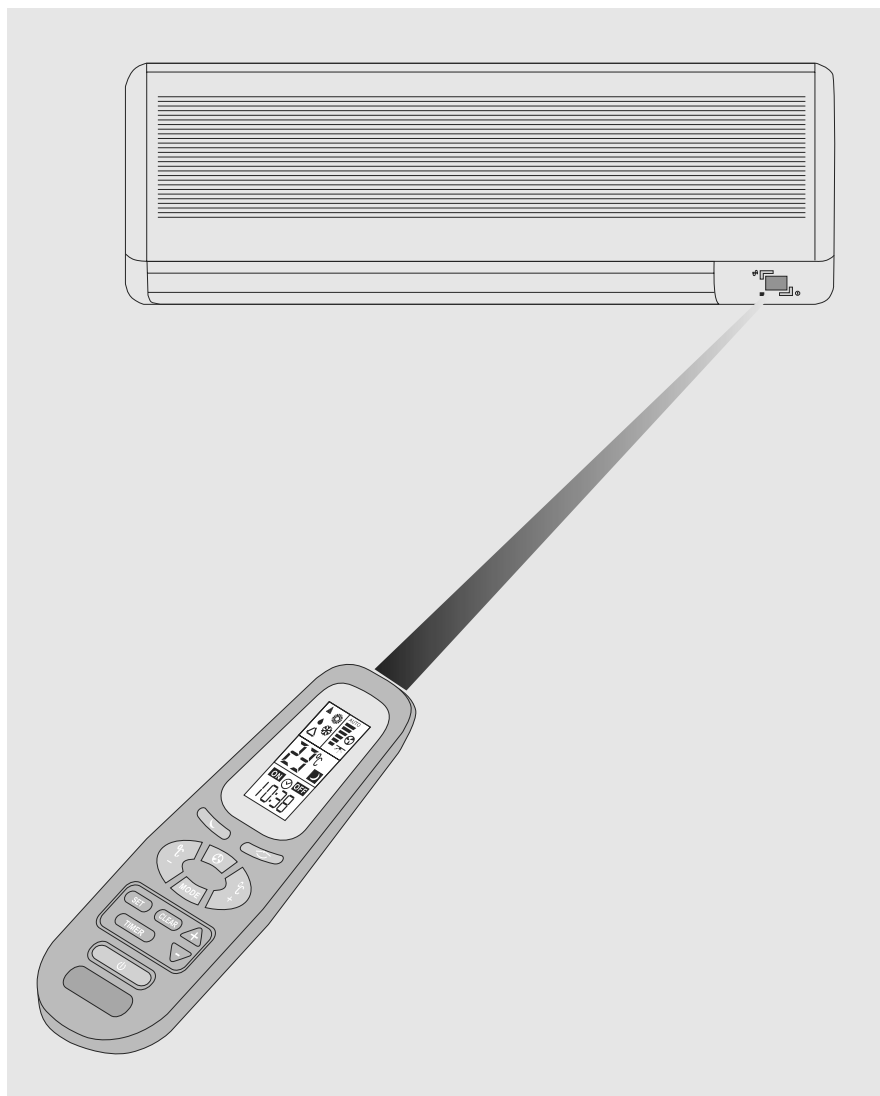

CARD TYPE REMOTE CONTROL PUTS ALL FUNCTIONS AT YOUR FINGERTIPS

- Aim at the infrared signal receiver on the room air conditioner when operating.
- The remote control signal can be received at a distance of up to about 7m.
- Be sure that there are no obstructions between the remote control and the signal receptor.
- Do not drop or throw the remote control.
- Do not place the remote control in a location exposed to direct sunlight, or next to a heating unit, and/or other heat source.
- Do not expose the air conditioner signal receiver(C) to a strong light such as fluorescent lamp or sunlight

ON-UNIT INDICATORS AND CONTROLS

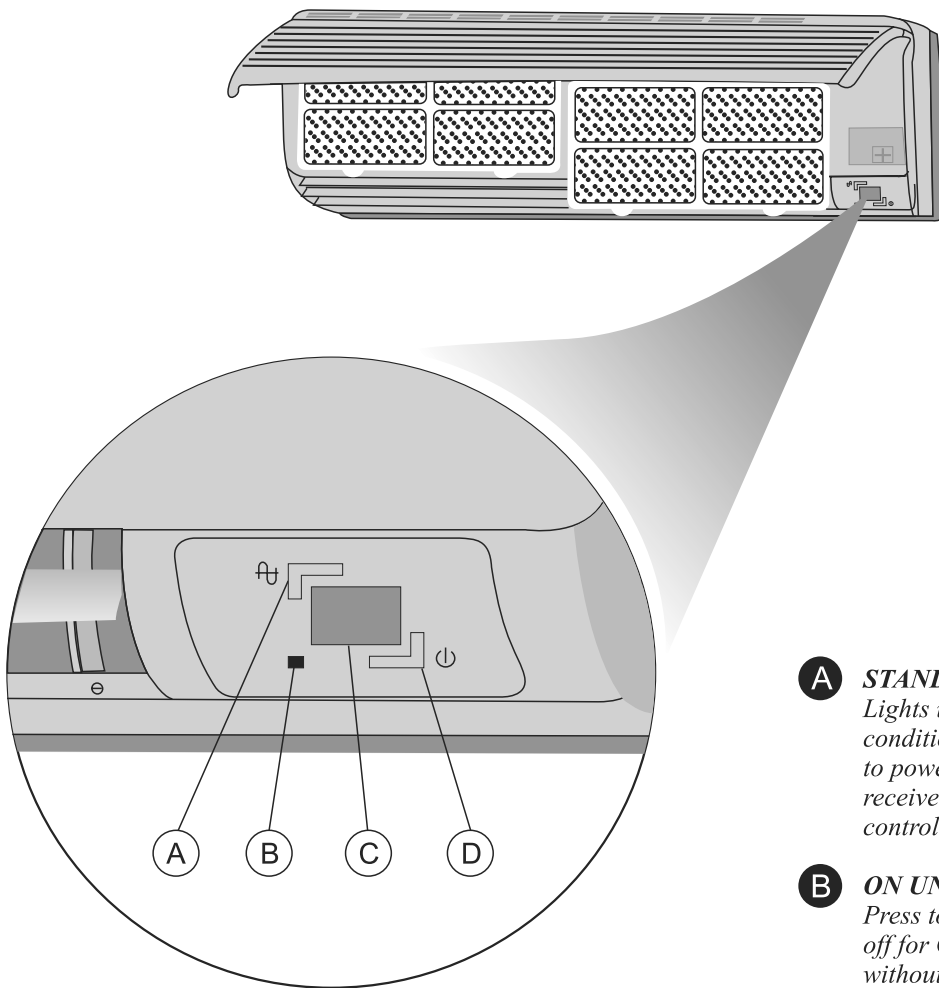

- A** **STAND-BY INDICATOR**
Lights up when the air conditioner is connected to power and ready to receive the remote control commands.
- B** **ON UNIT CONTROL**
Press to turn on or turn off for COOLING or HEATING without the use of remote control
- C** **SIGNAL RECEIVER**
Receive signals from the remote control.
- D** **OPERATION INDICATOR**
Lights up during operation. Blinks once to announce that the remote control infrared signal has been received and stored. Blinks continuously in protection mode.

REMOTE CONTROL

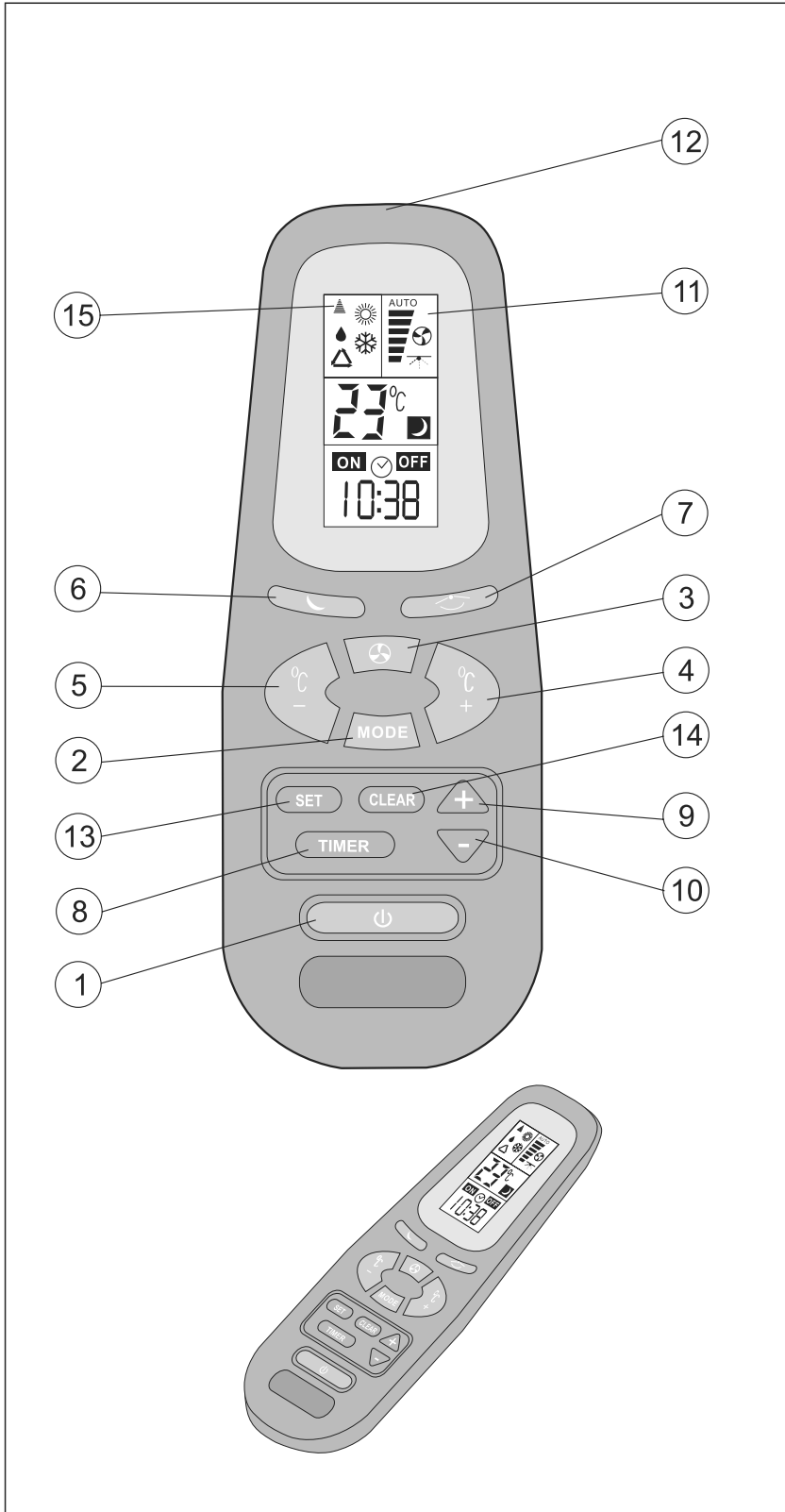

- ① *START/STOP button*
- ② *Operation mode selection button
COOLING
HEATING
AUTO COOL/HEAT
DRY
FAN*
- ③ *FAN SPEED and
AUTO FAN button*
- ④ *Setting point temperature
UP button*
- ⑤ *Setting point temperature
DOWN Button*
- ⑥ *SLEEP button*
- ⑦ *Airflow direction
AUTO-SWING
button*
- ⑧ *TIMER button*
- ⑨ *TIMER UP button*
- ⑩ *TIMER DOWN button*
- ⑪ *LCD operation display*
- ⑫ *Infrared signal
transmitter*
- ⑬ *TIMER SET button*
- ⑭ *TIMER CLEAR button*
- ⑮ *Transmission sign*

OPERATION PROCEDURE

TURNING ON THE AIR CONDITIONER

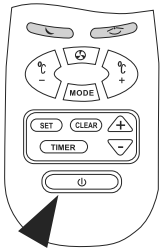

Press START/STOP button (1) to turn the air conditioner. After connecting to the power supply, The indicator (D) on the air conditioner light up, indicating that the air conditioner is in the standby status. Please note that LCD operation display (11) will always show the last mode of operation and the previous function used. If you want to change the control settings, proceed according to the following instructions. Otherwise, the air conditioner will start and operate in the same mode and functions prior to being turned off.

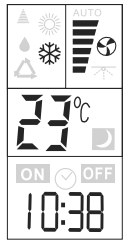

VENTILATING OPERATION

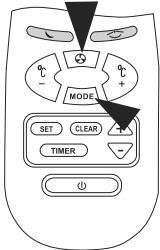

Select the ventilating mode by pressing MODE button (2). Switch to the desired fan speed by pressing FAN speed button (3).

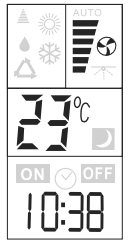

COOLING OPERATION

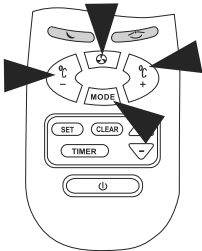

Select the COOLING mode by pressing MODE button (2). Switch to the desired FAN SPEED or to AUTO FAN by pressing button (3). Select suitable temperature setting. By selecting the COOLING mode, the air flap will move automatically to air delivery position, optimal for cooling.



COOLING OPERATION WITH AUTO FAN MODE

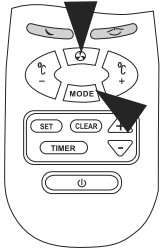

This operation starts with the highest air flow in order to quickly lower the room temperature. It will then automatically switch to the low air flow to quietly maintain the selected temperature.



HEATING OPERATION

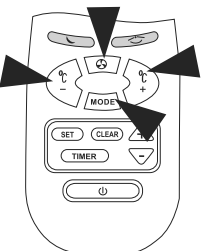

Select the HEATING mode by pressing MODE button (2). Switch to the desired FAN SPEED or to AUTO FAN by pressing FAN button (3). Select suitable temperature setting. By selecting the HEATING mode, the air flap will move automatically to air delivery position, optimal for heating.

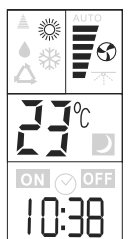

HEATING OPERATION WITH AUTO FAN MODE

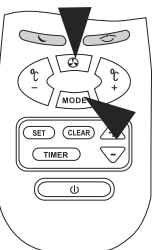

This operation starts with the highest air flow in order to quickly raise the room temperature. It will then automatically switch to a lower air flow to quietly maintain the selected temperature. HEATING with AUTO FAN will automatically provide the user with the HOT KEEP function. The fan will be turned off when the indoor coil temperature is not sufficiently hot to prevent uncomfortable cold air drafts.

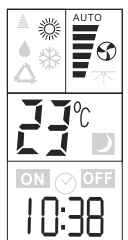

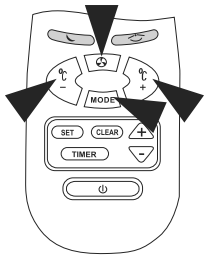

AUTO COOLING/HEATING OPERATION

Select the AUTO mode by pressing MODE button (2). Switch to the desired FAN SPEED or to AUTO FAN by pressing button (3). Select suitable temperature setting. The air flap will automatically move to either horizontal air delivery for cooling or to vertical air delivery for heating. At start, the air conditioner will select its mode of operation according to the room temperature and the temperature setting

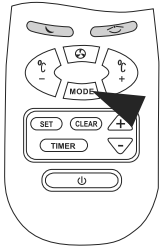
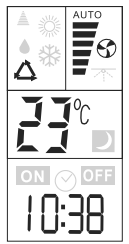

DRY OPERATION

Select the DRY mode by pressing MODE button (2). Select the suitable temperature setting. While in DRY mode, the air conditioner will operate at low fan speed, regardless of the fan setting on the LCD operation display. Fan might terminate operation from time to time to prevent from over cooling. By selecting the mode, the air flap will move automatically to optimal horizontal air delivery position.



SELECTING THE TEMPERATURE

Press TEMP button (4) or (5) to change the temperature setting in the LCD operation display(11).The temperature setting is shown in degrees centigrade. A higher number indicates a higher room temperature. A lower number indicates a lower room temperature.

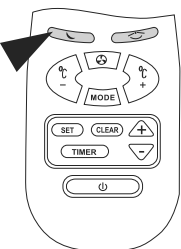

SLEEP FUNCTION

Press the SLEEP button (6) to select the SLEEP function. When the sleep function is activated the air conditioner will be automatically turned OFF after seven hours. If at the same time TIMER is activated, as well ,the air conditioner will be turned ON and OFF according to the TIMER setting.

To cancel the SLEEP function press on one of the following:

- START/STOP button (1)
- SLEEP button (6)

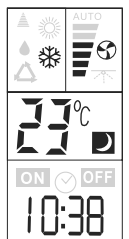

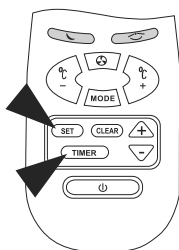

TIMER OPERATION

Press TIMER select button (8) to activate the timed operation mode. Each time you press TIMER button (8) is pressed, one of the following four type of operation modes will appear on the LCD display. The operation modes are sequenced in turn in the direction of arrow. Indicator (C) on the air conditioner will light up during TIMER operation.



Note: After power failure when the unit is in timer mode indicator (D) will be blinking and the unit will be automatically turned to stand-by mode and the timer operation will be cancelled. To resume the timer wait 30 sec. before reprogramming. Follow the instructions above.

TIMER OPERATING MODES

I. TIMER ON

This mode enables you to set a start operating time. Press the TIMER button (8) till ON sign blinks. Start time can be adjusted using up and down buttons (9) and (10) respectively. Press SET button (13) to activate the timer.

Example: Operation is restored at 10:30 a.m.

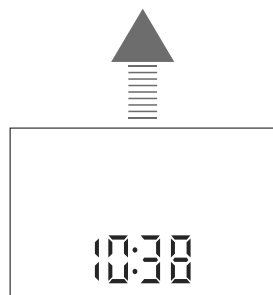
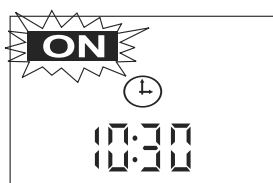

II. TIMER OFF

This mode enables you to set the stop time of operation. Press the Timer button (8) till the OFF sign blinks. Time can be adjusted using up and down buttons (9) and (10) respectively. Press Set button (13) to activate the timer.

Example: Operation stops at 18:00.

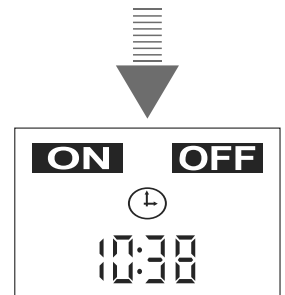
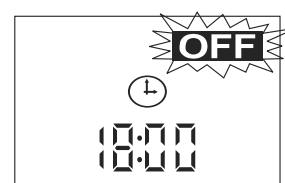

IV. CLEAR

Use this mode to cancel timer operation. Press CLEAR button (14), timer operation will terminate and the LCD display will be cleared for each timer mode.

Note: If timer button (8) is selected and neither time adjust, SET, or CLEAR buttons are not pressed within 15 seconds; the timer operation will be cancelled and the last setup will be displayed

III. TIMER ON/OFF

This mode enables you to set the start and stop time of operation. Press Timer button (8) till the ON sign blinks. By pressing again the OFF sign blinks. By press again the ON sign blinks. Time can be adjusted by using the up and down buttons (9) and (10) respectively. Press Set button (13) to activate the timer.

Example: Operation is restored at 10:30 a.m. Operation stops at 18:00

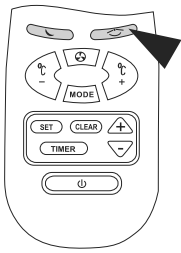

AUTOMATIC VERTICAL AIR SWING

Press button (7) to activate the auto air swing. By Pressing button (7) again you can stop the auto swing and position the air flap at any desired angle.

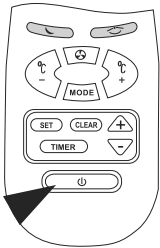

TURNING OFF THE AIR CONDITIONER

Press START/STOP button (1) to turn off the air conditioner. Indicator (B) on the air conditioner will be turned off. Indicator (A) will stay lit, indicating that the air conditioner is in STAND-BY mode and ready to accept any new command from the remote control. The remote control LCD will display the clock time. The last operating set-up will be kept for the next operation.

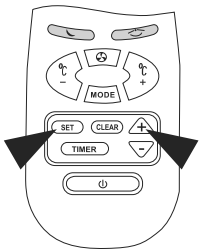

CURRENT CLOCK TIME SET

Clock setting is performed when batteries are inserted. The remote control displays the setting and the clock display will blink "0:00" or "12:00" AM (AM sign will blink, too) till a new time is set.

For clock setting, use buttons (9) and (10) for setting the hours and minutes, respectively, and then press timer SET button (13). The clock setting can be also performed by pressing time SET button (13) for 5 seconds.

The clock display will blink, for new setting follow the steps described above.



PROTECTION MODES

Your air conditioner includes several automatic protection modes, which enables you to use it virtually at any time and in any season, regardless of the outdoor temperature. Some of the protection modes are listed below:

Mode	Operation conditons	Protection from	Controlled remedy
Cooling	Low outdoor temperature	Indoor coil freezes up	Stops outdoor fan and compressor when approaching freezing conditions Resumes operation automatically.
	High outdoor temperature	Outdoor coil overheating	Stops compressor when approaching over heating conditions. Resumes operation automatically. Operating indicator(D) blinks.
Heating	Low outdoor temperature	Outdoor coil ice build up	Reverses Operation from heating to cooling for short periods to de-ice outdoor coil. Oiperating indicator (D) blinks.
	High indoor or outdoor temperature	Indoor coil overheating	Stops outdoor fan and compressor when approaching high indoor coil temperature. Resumes operation automatically.

CARE AND MAINTENANCE

Before performing any maintenance procedure, make sure to disconnect the air conditioner from the power.

CLEANING THE AIR FILTER

- To remove the air filters lift up the panel. Push the air filters up slightly to unlock them. Pull out the filters clean the filter by washing in warm soapy water and dry thoroughly. Align and fit the filters in place. Close the panel by pushing it in the center to lock it in place.

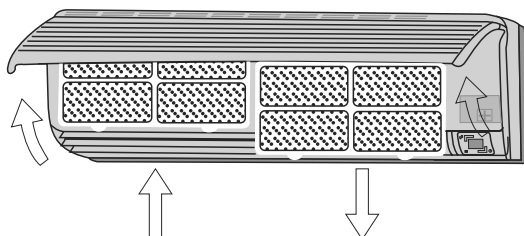

CLEANING THE AIR CONDITIONER

- Wipe the unit with a soft dry cloth or clean it using a vacuum cleaner.
- Do not use hot water or volatile materials which could damage the surface of the air conditioner.

AT THE BEGINNING OF THE SEASON

- Make sure there are no obstacles blocking the flow of inlet or outlet air, in both indoor and outdoor units.
- Make sure the power is properly connected.

PROTECT THE ELECTRONIC SYSTEM

- Indoor unit and remote control must be at least 1 meter away from a TV, radio or any other home electronic appliance.
- Protect the indoor unit from direct sun or lighting.

REMOTE CONTROL BATTERY CHANGE

- Remove the batteries from the remote control as shown.
- Use two 1.5 volt size AAA batteries

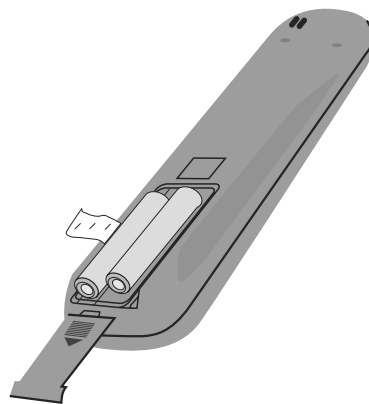

OPERATING TIPS

- Set a suitable room temperature; excessively low room temperature is not good for your health and wastes electricity. Avoid frequent setting of the temperature.
- During cooling, avoid direct sun. Keep curtains and blinds closed. Close doors and windows to keep the cool air in the room.
- Avoid generating heat or using of heating appliances while the air conditioner in cooling mode.
- Make sure that the air flap is positioned properly: horizontal flow in cooling and downward vertical flow for heating.
- Keep the room temperature uniform by adjusting the left/right vertical air blades.
- Position the air flap and the left/right air blades in such a manner as to prevent your body from being exposed directly to air drafts.
- During prolonged operation, ventilate the room occasionally by opening a window from time to time.
- In a power failure, the microprocessor memory is retained. When restarted, operation will be resumed in the last mode of operation.
- After turning on, allow more than 3 minutes for cooling, heating or dry operation to start.
- When COOL modes are used, make sure that the room's relative humidity is below 78%. If the unit is used for a prolonged periods of time in high humidity, moisture may form on the air outlet and drip down.
- Remote control signals may not be received if the indoor unit controls cover is exposed to direct sunlight or strong light. In such a case, block the sunlight or dim the lighting.
- The remote control is operative in a range of 7 meters. If you are out of range, the remote control may have difficulties in transmitting signals.

PRECAUTIONS

- Use the proper electrical fuse.

Do not pull out the power cord unless the unit is turned off.



- Do not start or stop operation by disconnecting the power cord.



- Do not obstruct or block the air inlet or air outlet of the air conditioner.

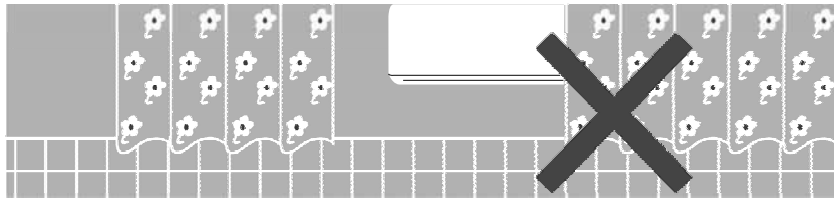

- Do not insert any objects in the air outlet of the indoor or outdoor units.



- Do not splash water on the air conditioner.

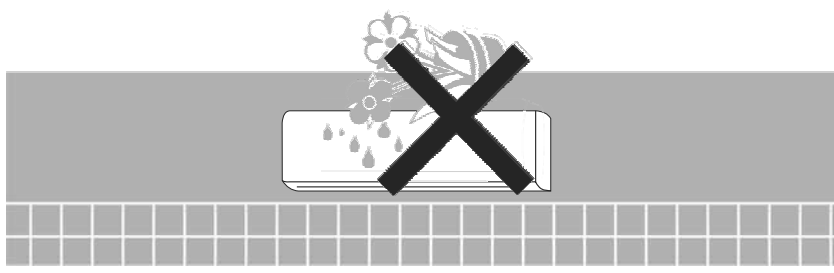

IF NOISE IS HEARD

There may be hissing sound during operation or just after shut down. this is caused by the refrigerant that is circulating inside the unit

There may be a cracking sound at starting and stopping the unit's operation. This is caused by heat expansion or contraction of plastics.

BEFORE CALLING FOR SERVICE

Before calling for service, please check the following common malfunctions and correct it as needed.

Problem	Cause	Remedy
<ul style="list-style-type: none"> Unit does not operate. Stand-by indicator does not light up 	<ul style="list-style-type: none"> <input type="checkbox"/> Unit not connected to power <input type="checkbox"/> Power failure 	<ul style="list-style-type: none"> ■ Plug in the power cord ■ Check main fuse
<ul style="list-style-type: none"> unit does not operate. Stand-by indicator lights. 	<ul style="list-style-type: none"> <input type="checkbox"/> Remote control malfunctions 	<ul style="list-style-type: none"> ■ Check remote control batteries ■ Try to operate from a closer distance ■ Start from on-unit controls
<ul style="list-style-type: none"> Unit does not respond properly to remote control command 	<ul style="list-style-type: none"> <input type="checkbox"/> IR signal does not reach unit <input type="checkbox"/> Distance between remote control and unit too large or aimed at from improper angle <input type="checkbox"/> IR receiver on-unit exposed to strong light source 	<ul style="list-style-type: none"> ■ Check for obstruction between unit and remote control. Clear if needed. ■ Get closer to unit ■ Dim lights, fluorescents especially
<ul style="list-style-type: none"> Air does not blow out from indoor unit 	<ul style="list-style-type: none"> <input type="checkbox"/> De-icing protection mode is activated 	<ul style="list-style-type: none"> ■ Normal operation in HEATING mode
<ul style="list-style-type: none"> COOLING, or HEATING does not start immediately 	<ul style="list-style-type: none"> <input type="checkbox"/> 3-min. compressor delayed start 	<ul style="list-style-type: none"> ■ Normal operation for these modes
<ul style="list-style-type: none"> Unit functions but does not perform sufficiently 	<ul style="list-style-type: none"> <input type="checkbox"/> Improper temperature setting <input type="checkbox"/> Unit capacity insufficient for load or room size 	<ul style="list-style-type: none"> ■ Rreset temperature ■ Consult your dealer

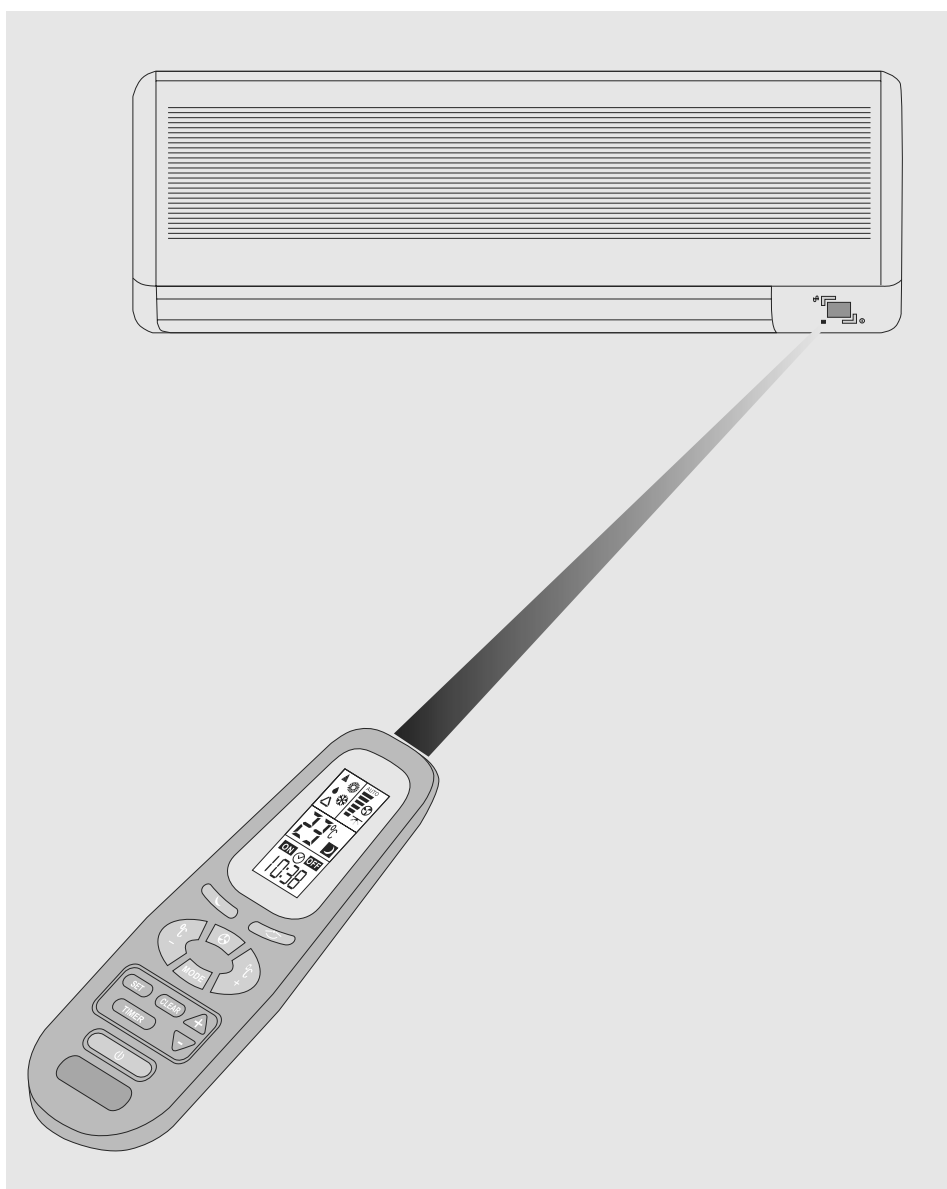

INSTALLATION INSTRUCTIONS

ENGLISH

INSTRUCTIONS D'INSTALLATION

FRANÇAIS

INSTRUCCIONES DE INSTALACION

ESPAÑOL

ISTRUZIONI PER L'INSTALLAZIONE

ITALIANO

INSTALLATIONSANLEITUNG

DEUTSCH







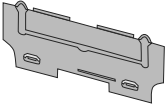

INSTALLATION INSTRUCTIONS

1. ACCESSORIES SUPPLIED WITH AIR CONDITIONER
2. LOCATION OF INDOOR AND OUTDOOR UNITS
3. ELECTRICAL REQUIREMENTS
4. INSTALLATION OF THE INDOOR UNIT
5. CONDENSATE HOSE CONNECTION
6. ELECTRICAL CONNECTIONS BETWEEN INDOOR AND OUTDOOR UNITS
7. REFRIGERANT TUBING
8. FINAL TASKS

The appliance shall not be installed in the laundry.

INSTALLATION INSTRUCTIONS FOR SPLIT WALL MOUNTED AIR CONDITIONER

1 ACCESSORIES SUPPLIED WITH THE AIR CONDITIONER

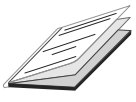
Shape	Name	Qty	Used for
	Mounting Plate	1	Wall mounting of the indoor unit
	Remote control With batteries	1	Operation of Unit
	Screws washers dowels	4	Wall mounting of indoor unit
	Outdoor unit drain connector	1	Outdoor unit water drain
	Mounting pads	4	Padding of outdoor unit bottom support
	Cable ties	4	Securing wires in the indoor and outdoor unit
	Cable terminals	1	Securing of grounding wire on the indoor and outdoor unit
	Twin wire cable (for heat pump units)	1	Transmitting signals
	Operation and installation instructions	2	Users and installers reference

2 LOCATION OF INDOOR AND OUTDOOR UNITS

Select the location considering the following:

INDOOR UNIT

1. Choose a location which will provide good air circulation. ensure that no objects or furnishings prevent air circulation.
2. Do not install the unit near a heat source or where it will be exposed to direct sunlight.
3. The location must allow convenient electrical draingage and tubing connections.
4. Installation site should provide an easy passage to outdoors.
5. The unit must be mounted on a strong wall that will withstand the generated vibrations.
6. Install the mounting plate as shown.

OUTDOOR UNIT

1. The location must allow easy servicing and provide good air circulation.
2. The unit may be suspended from a wall by a bracket (Optional) or located in a free standing position on the floor (preferably slightly elevated).
3. if the unit is suspended, ensure that the bracket is firmly connected and the wall is strong enough to withstand vibrations.
4. Unit location should not disturb neighbors with noise or exhaust air stream.
5. Place the mounting pads under the unit legs.
6. Install the outdoor unit as shown. Refer to the technical and service manual for allowed distances.
7. When the unit is installed on a wall, install the drain connector hose and drain plug as shown.

Fig.1

1. Bottom of outdoor unit
2. Drain connector

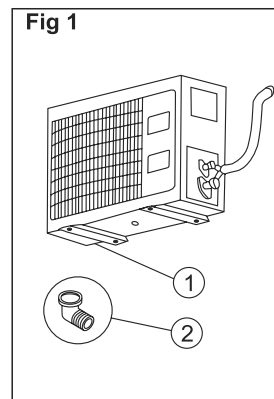

Fig.2

- Drain installation
- Example

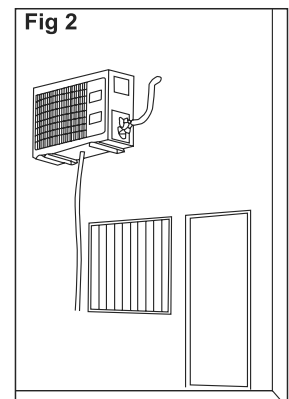

Fig.3
Length of electric cable to mains

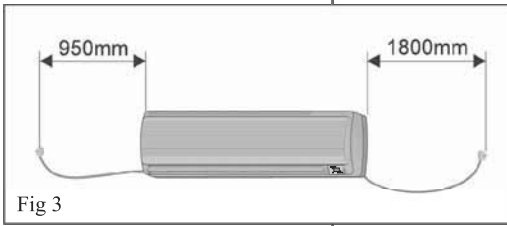

Fig 3

Fig.4
Direction of tubing

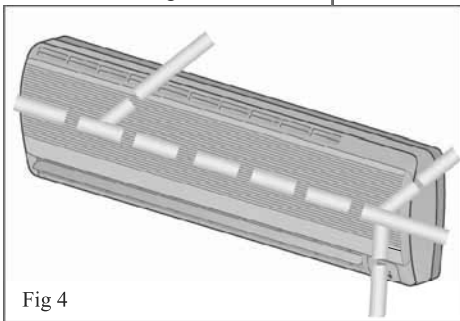

Fig 4

Fig.5

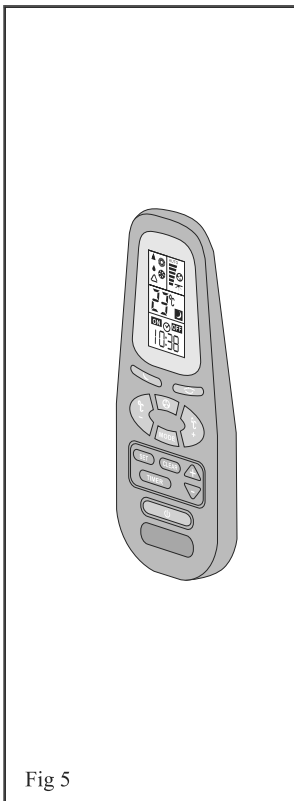

Fig 5

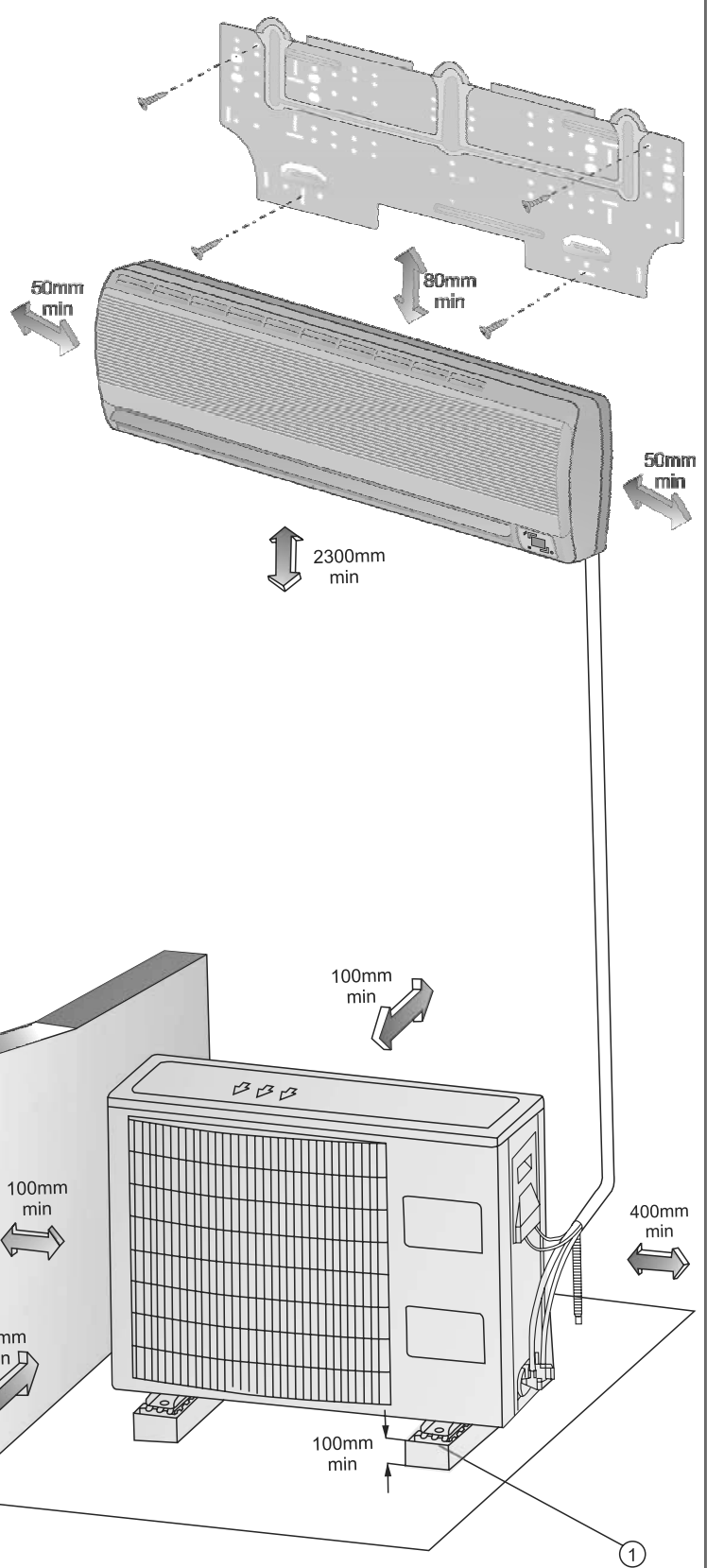

Fig.6
1.Mounting pads(x4)

Fig 6

3 ELECTRICAL REQUIREMENTS

Electrical wiring and connections should be made by qualified electricians and in accordance with local electrical codes and regulations. The air conditioner units must be grounded. The air conditioner unit must be connected to an adequate power outlet from a separate branch circuit protected by a time delay circuit breaker, as specified on unit's nameplate. Voltage should not vary beyond $\pm 10\%$ of the rated voltage.

4 INSTALLATION OF THE INDOOR UNIT

REMOVAL AND INSTALLATION OF THE FRONT PANEL

1. Open the front panel.
2. Place the horizontal deflection louvers in a horizontal position.
3. Open the screw caps on the panel front.
4. Unscrew the screws to release the front panel.
5. Remove the front panel by lifting it in the direction indicated by arrows.
6. After installation of the indoor unit, reinstall the front panel. Place the top end of the panel onto the top end of the indoor unit, press on the upper part of the panel, and at the same time push the bottom toward the indoor unit.
7. Replace the screw and their caps.

Fig.7

1. Lift front panel
2. Screw caps
3. Screw
4. Horizontal deflection levers
5. Screws
6. Front panel

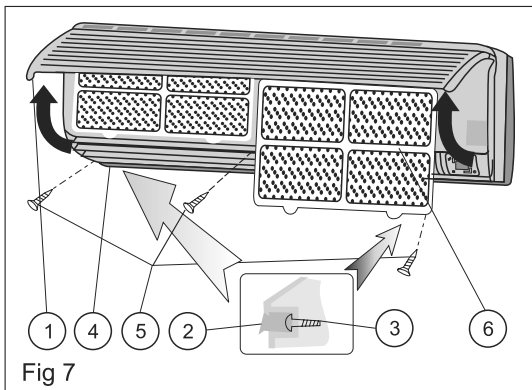

REFRIGERATION TUBE ROUTING

1. There are five possible routes for installing the refrigeration tube as shown.
2. For route (6), cut the bottom notch in the rear.
3. For routes (5) or (7), cut the side notches in the rear and in the front panel.

Fig.8

1. Front
2. Rear
3. Rear outlet
4. Lefthand outlet
5. Lefthand rar outlet
6. Bottom outlet
7. Righthand outlet

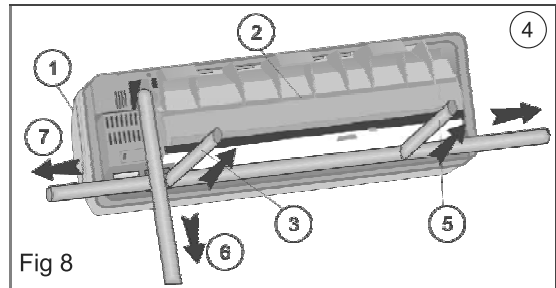

INSTALLATION OF THE MOUNTING PLATE

1. Figure 9 shows the location of the mounting plate relative to the unit size. Refer to one of the drawings, according to your unit length (marked in square).
2. Locate the mounting plate as shown on the wall in a horizontal position, using a spirit level.
3. Mark the position of the four mounting holes on the wall and drill four holes to accommodate the dowels.
4. Mount the mounting plate on to the wall by the four screws. Ensure screws are tightened properly.

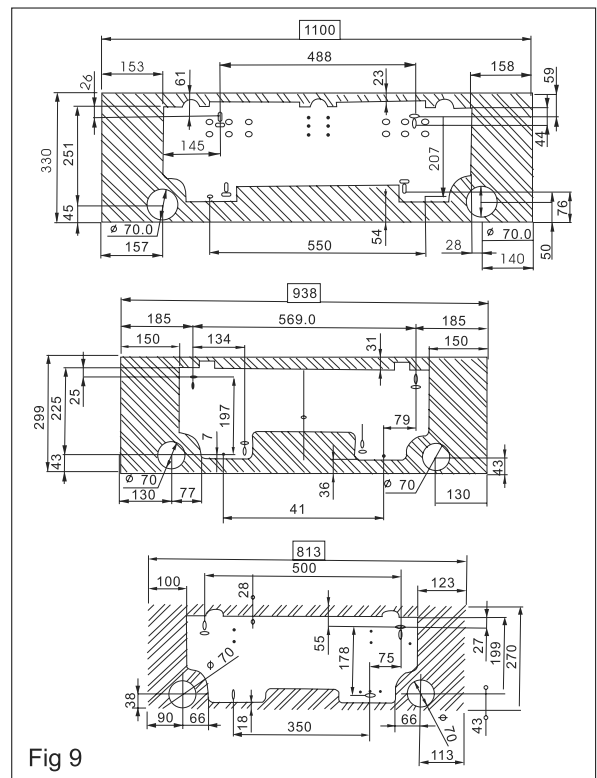

PENETRATION OF WALL FOR TUBING

1. Mark the location of the hole on either side of the mounting plate as shown. and drill it at a 5 downward angle, as shown.
2. The hole is drilled at an angle, to prevent condensed or rain water from penetrating back into the room
3. Trim the hole in the wall with a $\phi 70$ mm commercial plastic tube.

Fig. 10

- A. OUTDOOR SIDE 1. Drill 70 mm
B. INDOOR SIDE 2. Wall

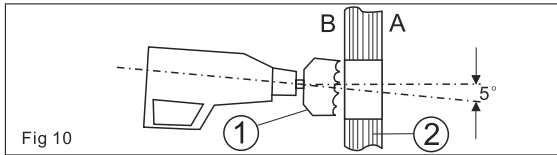

SUSPENDING AND RELEASING THE UNIT FROM THE MOUNTING PLATE

1. Make sure that the refrigerant tubes, electric cables and condensate water hose are well insulated with closed cell rubber based insulating tubes (6 mm thickness), are wrapped together with UV stabilized non-adhesive plastic tape, and are passed through the hole in the wall.
2. Hang the indoor unit on the two hooks that are located near the top edge of the mounting plate.
3. Press the lower part of the indoor unit against the mounting plate until the catches snap into the slots and lock the indoor unit to the mounting plate.
4. Check the installation by pulling the unit towards you.
5. To release the unit from the mounting plate, lift up the unit and then pull the unit towards you, to ensure that the hooks are locked.

Fig. 11

1. Indoor unit 3. Top hooks
2. Snap catches 4. Bottom hooks

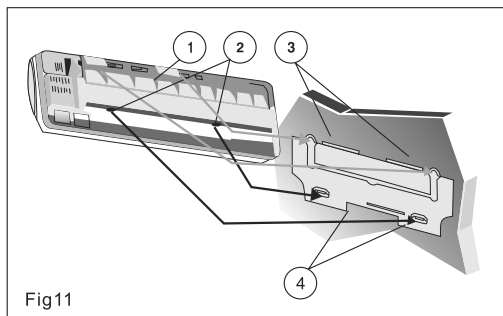
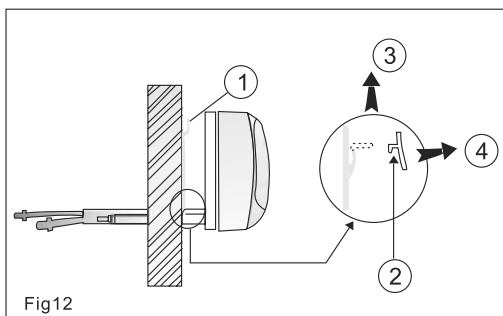

Fig. 12

1. Mounting plate 3. Lift up
2. Lower hook 4. Pull



5 CONDENSATE HOSE CONNECTION

1. Attach the condensate drain hose to the corrugated hose in the rear groove of the indoor unit.
2. Wrap the drain hose together with the refrigerant tubes and electrical cables.

Fig. 13

1. drain hose
2. Clamp
3. Downward slope

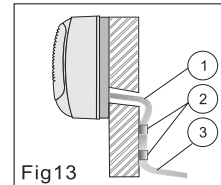

3. Ensure that the condensate drain hose is at all points installed in a downward slope manner.

Fig. 14

1. Trap
2. U-bend
3. End immersed in water

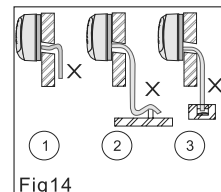

4. When installing the drain hose avoids traps and U-bends. The end of the drain hose should not be immersed in water.

Fig. 15

1. Electric cable
2. Refrigerant tubing
3. Condensate drain hose

5. For a lefthand outlet, lay the drain hose on the bottom of the indoor unit rear groove.

Fig 15

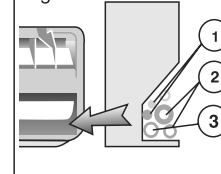
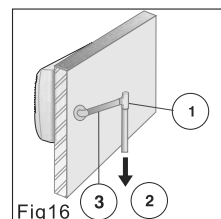

Fig. 16

1. Vent
2. Downward drain
3. Water drain hose

6. When the installation location requires long horizontal sections, a vent must be provided at the top of the hose to prevent overflow of the unit drain pan.



Upon completing the installation, test the water drain by pouring at least two liters of water into the unit drain pan. Check that the water drains off.

6

ELECTRICAL CONNECTIONS BETWEEN INDOOR AND OUTDOOR UNITS

1. To connect the indoor unit to the outdoor unit use the following electrical cables, protected for outdoor use:

Cooling and heating model:

Multiple wire cable - (220-240V,50Hz)
 5 wires x 1.5 mm²
 5 wires x 2.5 mm² (WMZ 22)
 5 wires x 0.5 mm² - for low voltage (supplied with the unit).

Cooling only models:

Multiple wire cable (220-240V,50Hz)
 4 wires x 1.5 mm²
 4 wires x 2.5 mm² (WMZ 22)

2. Prepare the multiple wire(7)cable ends for connection as shown in fig.18.
3. Connect the cable ends to the terminals of the indoor and outdoor units, as shown in fig.20.
4. Shape a loop and connect the yellow/green ground wire (2) to ground terminal screw of the indoor unit, as shown in fig.20a.
5. Prepare the twin wire cable end for connection as shown in fig.19.
6. Disconnect the resistor (5) from the indoor unit twin wire cable (3) and connect the win wire cable (6) connector instead.
7. connect the other end of the twin wire cable (6) to the outdoor unit twin wire terminal (9).
8. Secure the multiple wire power cable with the cable clamps.
9. Fasten the twin wire cable to the power cable with cable ties.

Fig.17

1.Terminal 2.Cover 3.Cable tie

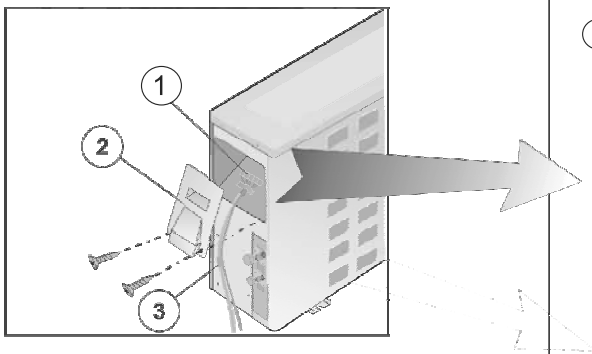

NOTES:

1. The wire color code can be selected by the installer.
2. Wires leading to outdoor unit twin wire terminal (9). must be in a separate twin wire cable, otherwise the electronic controls will be subjected to operational malfunctions.
3. For cooling only model, terminal number 5 should not be connected.

MULTIPLE WIRE POWER CABLE

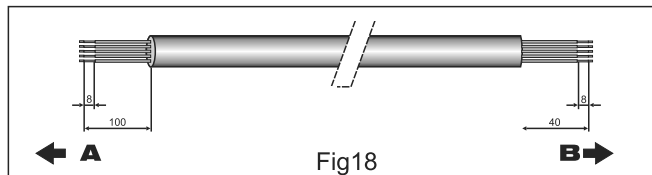

Fig18

Fig.18 A. OUTDOOR B. INDOOR

TWIN-WIRE LOW VOLTAGE CABLE

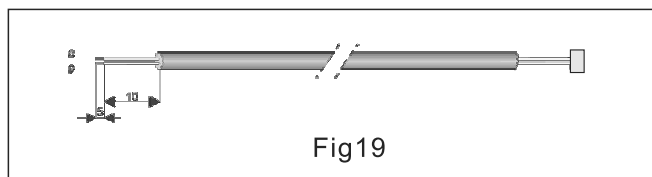

Fig19

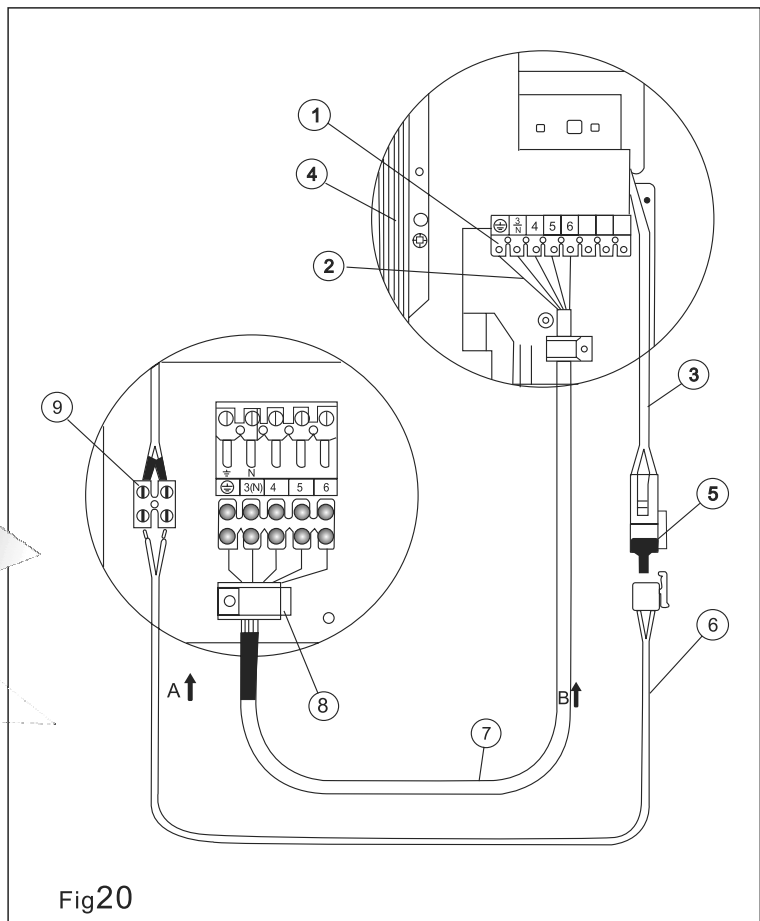

Fig20

Fig.20

1.Indoor unit terminal
 2.Ground wire
 3.Indoor twin wire cable
 4.Indoor coil

5.Resistor
 6.Twin wire cable
 7.Multiple wire cable
 8.Cable clamp

9.Outdoor twin wire terminal
 A.OUTDOOR B.INDOOR

7

REFRIGERANT TUBING

CONNECT THE INDOOR TO THE OUTDOOR UNIT

The indoor unit contains a small quantity of refrigerant. Do not unscrew the nuts from the unit until you are ready to connect the tubing. The outdoor unit is supplied with sufficient refrigerant charge. Refer to outdoor unit nameplate.

To prevent crushing, bend tubes using a bending tool.

NOTE: Use refrigeration type copper tubing only.

1. Use tubing diameter that corresponds to the tubing diameter of the indoor and outdoor units. (Note that the liquid and suction tubes have different diameters. (See tube size, torque tightening table.)
2. Place flare nuts on tube ends before preparing them with a flaring tool. Use the flare nuts that are mounted on the supplied outdoor and indoor units.
3. Connect the four ends of the tubing to the indoor and outdoor units.
4. Insulate each tube separately, and their unions, with at least 6 mm. of insulation. Wrap the refrigerant tubing, drain hose and electric cables together with a vinyl tape (UV protected).

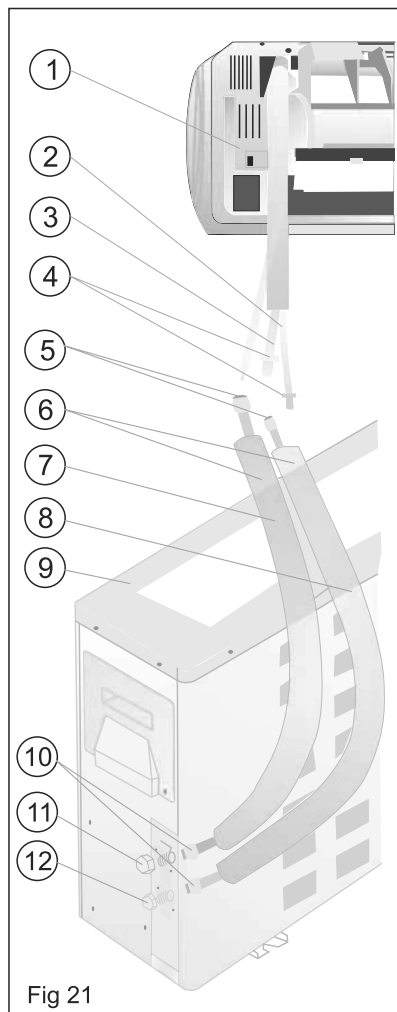

Caution!
When unscrewing the valve caps, do not stand in front of them or the spindles at any time, as the system is under pressure.

Fig.21
1. INDOOR UNIT
2. Liquid tube (small dia.)
3. Suction tube (large dia.)
4. Plugs
5. Flare nuts
6. Tubing between units
7. Suction tube
8. Liquid tube
9. OUTDOOR UNIT
10. Flare nuts
11. Suction valve (larger)
12. Liquid valve (small)

Tightening torques of unions and valve caps:

TUBE SIZE	TORQUE
Liquid line 1/4"	15-20 N.M.
Suction line 3/8"	30-35 N.M.
Suction line 1/2"	50-54 N.M.
Suction line 5/8"	75-78 N.M.

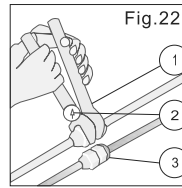

Fig. 22
1. Wrench
2. Torque wrench
3. Union

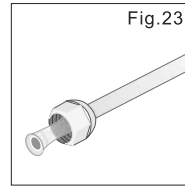

Fig. 23
To prevent refrigerant leakage, coat the flared surface with refrigeration oil

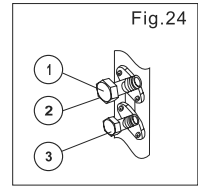

Fig. 24
1. Suction valve
2. Service port
3. Liquid valve

EVACUATION OF THE REFRIGERATION TUBES AND THE INDOOR UNIT

After connecting the unions of the indoor and outdoor units, purge the air from the tubes and indoor unit as follows:

1. Connect the charging hoses with a push pin to the low and high sides of the charging set and the service port of the suction and liquid valves. Be sure to connect the end of the charging hose with the push pin to the service port.
2. Connect the center hose of the charging set to a vacuum pump
3. Turn on the power switch of the vacuum pump and make sure that the needle in the gauge moves from 0MPa(0cm Hg) to -0.1 MPa (-76cm Hg). Let the pump run for fifteen minutes.
4. Close the valves of both the low and high sides of the charging set and turn off the vacuum pump. Note that the needle in the gauge should not move after approximately five minutes.
5. Disconnect the charging hose from the vacuum pump and from the service ports of the suction and liquid valves.
6. Tighten the service port caps of both suction and liquid valves.
7. Remove the valve caps from both valves, and open them using a hexagonal Allen wrench.
8. Remount valve caps onto both of the valves.
9. Check for gas leaks from the four unions and from the valve caps. Text with electronic leak detector or with a sponge immersed in soapy water for bubbles.

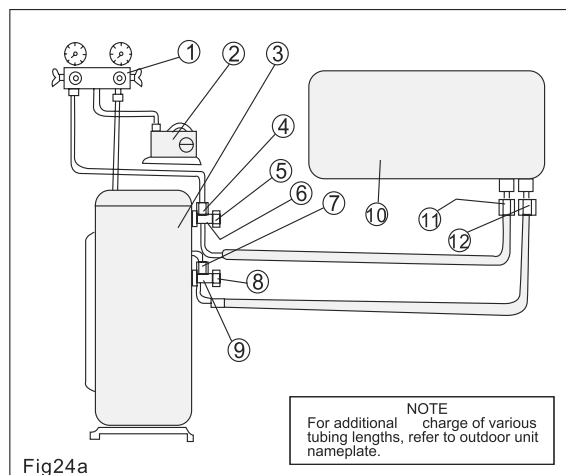

Fig.24a
1. Charging set
2. Vacuum pump
3. OUTDOOR UNIT
4. Service valve
5. Cap
6. Suction valve
7. Service valve*
8. Cap
9. Liquid valve
10. INDOOR UNIT
11. Suction flare connection
12. Liquid flare connection
*In some models only

NOTE
For additional charge of various tubing lengths, refer to outdoor unit nameplate.

8

FINAL TASKS

1. Replace all valve caps and ensure that they are tightened properly.
2. Fill gaps on the wall between hole sides and tubing with sealer.
3. Attach wiring and tubing to the wall with clamps where necessary.
4. Operate the air conditioner together with the customer and explain all functions.
5. Explain filter removal, cleaning and installation.
6. Give the operating and installation manuals to the customer.