

**ENGLISH**

# OPERATING MANUAL

**HAD RANGE  
R410A**

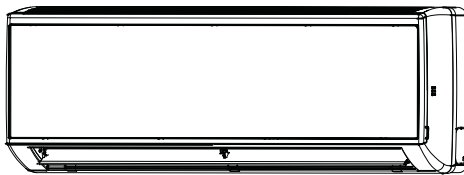

## CONTENT

- FEATURES AND FUNCTIONS ..... 1
- PRECAUTIONS ..... 2
- NAME OF EACH PART ..... 3-4
- OPERATION ..... 5
- PROTECTION MODES ..... 6
- CARE AND MAINTENANCE ..... 7-8
- TROUBLESHOOTING ..... 9
- EXCEPTION FOR MULTI  
SPLIT TYPE ..... 10



**Thank you for  
purchasing our  
Room Air Conditioner.**

Before using your air-conditioner, please read this operating instruction carefully and keep it for future reference.

Part No. 468100332/01  
OM . HAD/JAD 1-N.1 GB

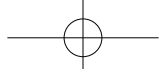

# FEATURES AND FUNCTIONS

## INVERTER

At the start of operation, a large power is used to bring the room quickly to the desired temperature. Afterwards, the unit automatically switches to a low power setting for economic and comfortable operation

## VERTICAL AIR SWING

Automatic swing of supply air in vertical direction. The flap moves automatically in upward and downward direction to spread the conditioned air evenly throughout the room.

## WIRELESS REMOTE CONTROL UNIT

The Wireless Remote Control Unit allows convenient control of air conditioner operation.

## AUTO CHANGE OVER

The operation mode (cooling, dry, heating) is switched automatically to maintain the set temperature, and the set temperature is kept constant at all times.

## OPERATING TEMPERATURE RANGE

		Indoor		Outdoor	
		DB[°C]	WB[°C]	DB[°C]	WB[°C]
Cooling	Upper Limit	32	23	46	NA
	Lower Limit	21	15	10	NA
Heating	Upper Limit	27	NA	24	18
	Lower Limit	10	NA	-15	-16

## SLEEP TIME

When the SLEEP button is pressed during heating mode, the air conditioner's thermostat setting is gradually lowered during the period of operation; during cooling mode, the thermostat setting is gradually raised during the period of operation. When the set time is reached, the unit automatically turns off.

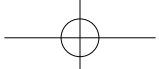

# PRECAUTIONS

## **Danger**

This sign warns of death or serious injury.

- Do not attempt to install this air conditioner by yourself.
- This unit contains no user-serviceable parts. Always consult authorized service personnel for repairs.
- When moving, consult authorized service personnel for disconnection and installation of the unit.
- Do not become excessively chilled by staying for lengthy periods in the direct cooling airflow.
- Do not insert fingers or objects into the outlet port or intake grilles.
- Do not start and stop air conditioner operation by disconnecting the power supply cord and so on.
- Take care not to damage the power supply cord.
- In the event of a malfunction (burning smell, etc.), immediately stop operation, disconnect the power supply plug, and consult authorized service personnel.
- If the power supply cord of this appliance is damaged, it should only be replaced by the authorized service personnel, since special purpose tools and specified cord are required.
- The appliance is not intended for use by young children of infirm persons without supervision.
- Please pre-heat the air conditioner for at least 12 hours before operation. If use it for a long time, please keep the power on.

## **Caution**

This sign warns of damage to property.

- Provide occasional ventilation during use.
- Do not direct air flow at fireplaces or heating apparatus.
- Do not climb on, or place objects on the air conditioner.
- Do not hang objects from the indoor unit.
- Do not set flower vases or water containers on top of air conditioner.
- Do not expose the air conditioner directly to water.
- Do not operate the air conditioner with wet hands.
- Do not pull power supply cord.
- Turn off power source when not using the unit for extended periods.
- Check the condition of the installation stand for damage.
- Do not place animals or plants in the direct path of the air flow.
- Do not drink the water drained from the air conditioner.
- Do not use in applications involving the storage of foods, plants or animals, precision equipment, or art works.
- Connection valves become hot during heating; handle with care.
- Do not apply any heavy pressure to radiator fins.
- Operate only with air filters installed.
- Do not block or cover the intake grille and outlet port.
- Ensure that any electronic equipment is at least one metre away from either the indoor or outdoor units.
- Avoid installing the air conditioner near a fireplace or other heating apparatus.
- When installing the indoor and outdoor units, take precautions to prevent access to infants.
- Do not use inflammable gases near the air conditioner.

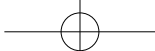

# NAME OF EACH PART

## INDOOR UNIT

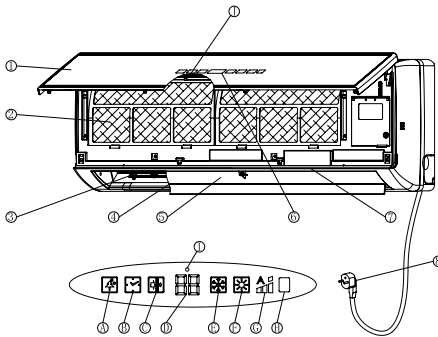

- ① Air intake grill
- ② Air filter
- ③ Supply air flap (louver)
- ④ Horizontal air flow deflecting louvers
- ⑤ Air outlet
- ⑥ Unit's indications and on unit control
- ⑦ Ionizer (optional)
- ⑧ Power cord (optional)

## Part names and function

### A Ionizer

The icon will light up when Bi-Polar ionizer is activated via remote control. It will light up for about 15 seconds before goes off. (only applicable to units fitted with Bi-Polar Ionizer)

### B Timer

The icon will light up when Timer or Sleep operation is activated. During this mode, upon receiving any signal from Remote Control (RC), the light will come up strong and deemed after about 15 seconds.

### C Filter

If the icon light up (for about 30 seconds after other display is going off), it means that filter should be cleaned. The icon will light up again every time a signal is received from RC, until it is reset. To reset the filter icon, press the reset button (J) and release quickly. The icon will light up for about 2 seconds and off, indicating the filter icon had been reset.

### D Temperature Icon

This icon indicate the set point temperature (SPT). During operation mode, upon receiving any signal from Remote Control (RC), the SPT will be displayed for 15 seconds before it goes off.

### E COOL Icon

The icon will light up if the operation mode is set to "COOL", "DRY" or "AUTO". After around 15 seconds, the icon will be deemed. Upon receiving any signal from

Remote Controller (RC), the light will come up strong and deemed after about 15 seconds.

### F HEAT icon

The icon will light up if the operation mode is set to "HEAT". After around 15 seconds, the icon will be deemed. Upon receiving any signal from Remote Controller (RC), the light will come up strong and deemed after about 15 seconds.

### G Fan Speed

The indoor fan speed set by user will be indicated as below:

- a) low
- b) Medium
- c) High
- d) Strong
- e) Auto

### H Infra-Red (IR) receiver

Receive signal from the Remote Controller (RC)

### I Standby LED

This LED will be light up when the unit is on Standby. It will turn off when unit is in operation.

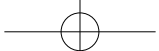

# NAME OF EACH PART

## ① MODE/RESET Button

This is a multi-function button. It is a MODE button before the Filter Icon has lighted up. After the Filter Icon has lighted up, it will become a RESET button. Once the filter is RESET, it will become a MODE button again.

## Mode Function:

Every short pressing , the next operation mode is selected, in this order: SB → Cool Mode → Heat Mode → SB → ...  
In long pressing system enters diagnostic mode.

## Reset Function:

Short pressing reset the filter counter.

## Attention:

Heat and Stand-by indicator light up in red, all the others light up in white  
Blinks continuously during Indoor/Outdoor protections. During Heat mode the Heat Icon blinks, and during Cool, Dry, Or Auto modes the Cool Icon blinks

## OUTDOOR UNIT

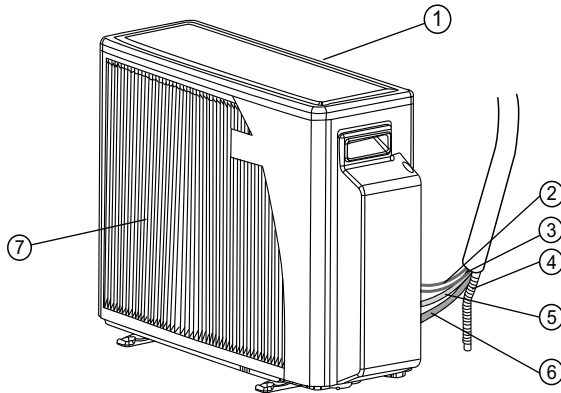

- |                           |                           |
|---------------------------|---------------------------|
| ① Outdoor unit air intake | ⑤ Liquid line             |
| ② Power cable             | ⑥ Suction line            |
| ③ Control Wire(optional)  | ⑦ Outdoor unit air outlet |
| ④ Drain hose              |                           |

Note: These instructions also apply if the products differ externally to those appearing in the manual

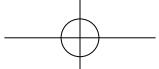

# OPERATION TIPS

- Set a suitable room temperature; excessively low room temperature is not good for your health and wastes electricity. Avoid frequent setting of the temperature.
- During cooling, avoid direct sun. Keep curtains and blinds closed. Close doors and windows to keep the cool air in the room.
- Avoid generating heat or using of heating appliances while the air conditioner in cooling mode.
- Make sure that the air flap is positioned properly: horizontal flow in cooling and downward vertical flow for heating.
- Keep the room temperature uniform by adjusting the left/right vertical air blades.
- Position the air flap and the left/right air blades in such a manner as to prevent your body from being exposed directly to air drafts.
- During prolonged operation, ventilate the room occasionally by opening a window from time to time.
- In a power failure, the microprocessor memory is retained. When restarted, operation will be resumed in the last mode of operation. However, if the timer was used, the unit will be turned off by the timer only if the remote control is aimed at the unit. Otherwise the power failure will cause the timer data to be erased from the microprocessor memory.
- After turning on, allow more than 3 minutes for cooling, heating or dry operation to start.
- When DRY mode is used, make sure that the room temperature is between 20°C and 27°C. When used out of this range, the unit may protect itself and become inoperative.
- When COOL or DRY modes are used, make sure that the room's relative humidity is below 78%. If the unit is used for a prolonged periods of time in high humidity, moisture may form on the air outlet and drip down.
- Remote control signals may not be received if the indoor unit controls cover is exposed to direct sunlight or strong light. In such a case, block the sunlight or dim the lighting.
- The remote control is operative in a range of 8 meters. If you are out of range, the remote control may have difficulties in transmitting signals.

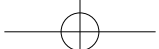

# PROTECTION MODES(optional)

Your air-conditioner includes several automatic protection modes which enables you to use it virtually at any time and in any season regardless of the outdoor temperature. Some of the protection modes are listed below:

Mode	Operation conditions	Protection from	Controlled remedy
Cool And Dry	Low outdoor temperature	Indoor coil freezes up	Stops outdoor fan and compressor when approaching freezing conditions Resumes operation automatically. Operating indicator blinks
	High outdoor temperature	Outdoor coil overheating	Stop compressor when approaching over heating conditions. Resumes operation automatically. Operating indicator blinks
Heating	Low outdoor temperature	Outdoor coil ice build up	Reverses Operation from heating to cooling for short periods to de-ice outdoor coil. Operating indicator blinks
	High Indoor or outdoor temperature	Indoor coil overheating	Stops outdoor fan and compressor when approaching high indoor coil temperature. Resumes operation automatically. Operating indicator blinks

Note: When switching the unit to OFF after heating operation, the unit may perform outdoor coil deicing operation. In such a case, the compressor will continue to run for some time after the unit has switched to OFF, and the indoor unit louvers are closed. This feature is a part of the normal unit operation

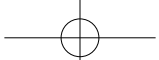

# CARE AND MAINTENANCE

Before performing any maintenance procedure, make sure to disconnect the air conditioner from the power.

## HOW TO CLEAN THE FLAT PANEL

Open the front panel, and then use your fingers to push up the flat panel.  
The flat panel must be cleaned by soft cloth with water or mild cleanser.  
Avoid using abrasive or corrosive cleanser.  
Never apply any chemical for cleaning.

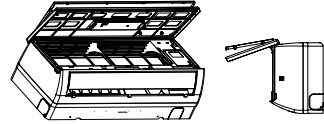

## HOW TO INSTALL THE FLAT PANEL

Please make sure each clasp matches the slot.

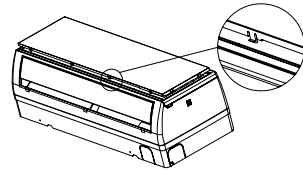

## HOW TO REMOVE THE FLAT PANEL

Open the front panel and push it to the right, then pull out the right crank, and then pull the front panel to the left and take it out from the front frame.

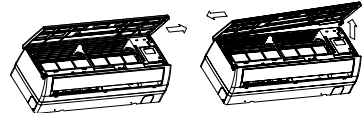

## CLEANING THE AIR FILTER

To remove the air filters, lift up the panel, push the air filters up slightly to unlock them, pull out the filters, clean the filter by washing in warm soapy water and dry thoroughly. Align and fit the filters in place. Close the panel by pushing it in the center to lock it in place.

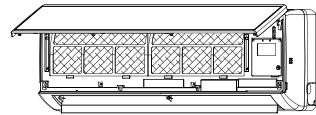

If your air conditioner is provided with a filter cleaning indicator, when the indicator lights up, you should remove the filters for cleaning, then use the Reset button to return off the indicator after cleaning.

**DO NOT OPERATE THE UNIT WITHOUT FILTERS!**

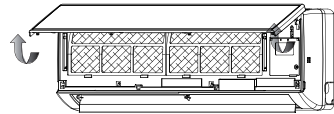

## PURIFICATION FILTER REPLACEMENT

The air purifying filter should be removed from the unit and replaced once a year, show as following:

- 1 Pulling out the filter.
- 2 Replacing the filter in its place.

Note: The above procedure is used for replacing the active carbon filter (when supplied).

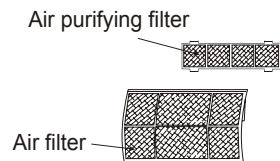



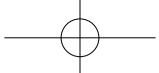

# CARE AND MAINTENANCE

## CLEANING THE AIR CONDITIONER

- Wipe the unit with a soft dry cloth or clean it using a vacuum cleaner.
- Do not use hot water or volatile materials which could damage the surface of the air conditioner.

## AT THE BEGINNING OF THE SEASON

- Make sure there are no obstacles blocking the flow of inlet or outlet air, in both indoor and outdoor units.
- Make sure the power is properly connected.

## PROTECT THE ELECTRONIC SYSTEM

- Indoor unit and remote control must be at least 1 meter away from a TV, radio or any other home electronic appliance.
- Protect the indoor unit from direct sun or lighting.

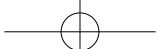

# TROUBLESHOOTING

Before calling for service, please check the following common malfunctions and correct it as needed.

Problem	Cause	Remedy
<ul style="list-style-type: none"> <li>Unit does not operate. Stand-by indicator does not light up</li> </ul>	<ul style="list-style-type: none"> <li><input type="checkbox"/> Unit not connected to power</li> <li><input type="checkbox"/> Power failure</li> </ul>	<ul style="list-style-type: none"> <li>■ Plug in the power cord</li> <li>■ Check main fuse</li> </ul>
<ul style="list-style-type: none"> <li>Unit does not operate. Stand-by indicator lights.</li> </ul>	<ul style="list-style-type: none"> <li><input type="checkbox"/> Remote control malfunctions</li> <li><input type="checkbox"/> The remote control is locked</li> </ul>	<ul style="list-style-type: none"> <li>■ Check remote control batteries</li> <li>■ Try to operate from a closer distance</li> <li>■ Start from on-unit controls</li> <li>■ Unlock the remote control</li> </ul>
<ul style="list-style-type: none"> <li>Unit does not respond properly to remote control command</li> </ul>	<ul style="list-style-type: none"> <li><input type="checkbox"/> IR signal does not reach unit</li> <li><input type="checkbox"/> Distance between remote control and unit too large or aimed at from improper angle</li> <li><input type="checkbox"/> IR receiver on-unit exposed to strong light source</li> </ul>	<ul style="list-style-type: none"> <li>■ Check for obstruction between unit and remote control. Clear if needed.</li> <li>■ Get closer to unit.</li> <li>■ Dim lights, fluorescent especially</li> </ul>
<ul style="list-style-type: none"> <li>Air does not blow out from indoor unit</li> </ul>	<ul style="list-style-type: none"> <li><input type="checkbox"/> De-icing protection mode is activated</li> <li><input type="checkbox"/> Unit in AUTO FAN mode</li> <li><input type="checkbox"/> Over cooling in DRY</li> </ul>	<ul style="list-style-type: none"> <li>■ Normal operation in HEATING mode</li> <li>■ Normal operation in DRY mode</li> </ul>
<ul style="list-style-type: none"> <li>COOLING, DRY or HEATING does not start immediately</li> </ul>	<ul style="list-style-type: none"> <li><input type="checkbox"/> 3-min. Compressor delayed start</li> </ul>	<ul style="list-style-type: none"> <li>■ Normal operation for these modes</li> </ul>
<ul style="list-style-type: none"> <li>Unit functions but does not perform sufficiently</li> </ul>	<ul style="list-style-type: none"> <li><input type="checkbox"/> Improper temperature setting</li> <li><input type="checkbox"/> Unit capacity in sufficient for load or room size</li> </ul>	<ul style="list-style-type: none"> <li>■ Reset temperature</li> <li>■ Consult your dealer</li> </ul>

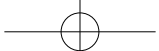

# EXCEPTION FOR MULTI SPLIT TYPE

In multi split applications where more than a single indoor unit is connected to the same outdoor unit, it may happen that the requested operation mode can not be operated.

The reason for that is that the system is currently operating in a different mode.

The system operation mode can be either cooling or heating and is set by the outdoor unit controls, based on indoor and outdoor unit settings.

The rules for the mode settings may be different from one application to another.

In most applications the system operation mode will not be changed as long as there is an operating indoor unit requesting the active mode.

The operation mode in such application will be set by the first indoor unit that is turned ON from Stand By.

The following table shows the indoor unit operation modes that can be operated per active system mode:

		System Active Mode	
		Cooling	Heating
Requested indoor unit operation mode	Cooling	V	X
	Heating	X	V
	Dry	V	X
	Auto Cool/Heat	v (cooling only)	v (heating only)
	Ventilation	V	X

(v - enabled indoor unit operation mode, X - disabled indoor unit operation mode)

## **Indoor unit operation when the requested mode is disabled is as following:**

- Louver opens;
- Green (OPER) LED blinks once in two seconds;
- Indoor fan is forced off;

