

www.airwell.com

Airwell



Catalogue MVI
R410A Mini Variable Inverter

Flexible Solution for each building characteristics

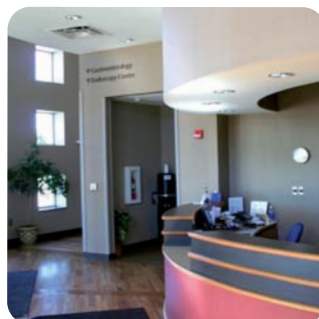

Each building has its own characteristics.

Not only the type of each construction is different but also its size, shape and age, which makes it unique. Because of this each building needs to have its individual technical equipment.

This is why MVi system was developed. MVi is as flexible as the need of the each individual building type. MVi is an intelligent and flexible system, which is not only able to adapt to different applications but also to different room sizes, temperature zones and construction stages.

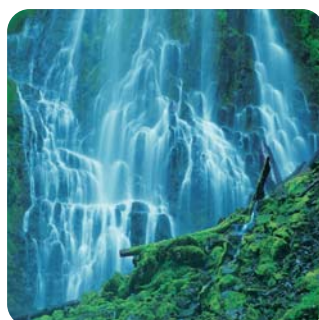

OPTIMAL ENERGY SAVINGS – GOOD FOR THE ENVIRONMENT

The energy efficiency of the MVi range is exceptional thanks to the use of DC Inverter compressors and the use of variable speed fan motors. As the units operate using R410A, the entire range of products contributes to preserve the environment (high performance “green” fluid, recyclable and harmless to the ozone layer, reduction in energy consumption) within the framework of the Renewable Energy plan.

Maximum Installation Flexibility

MVi is as flexible as your unique building and can be fully customised to your HVAC needs. One complete MVi VRF system contains one MVi VRF outdoor unit and up to 8 indoor units of different designs plus the control to manage the whole system individually. The «beauty» of this system is the easiness of installation which makes this system ideal as well for the installations, replacement or a combination of both. The MVi system allows you to install the indoor units either floor by floor or zone by zone.

The same principle can be used for maintenance so that the entire building doesn't have to shut down. The indoor units are available in different versions like Airwell floor/ceiling, cassette and ducted, which provides a maximum of flexibility to equip each room individually according to capacity and location. MVi indoor and outdoor units are designed to provide the quickest possible operation. The system operates at minimum sound level which is a major benefit in most of facility applications. The Hi-Wall indoor unit for example is running from 29 decibels at low speed. This is equivalent to the range of noise you make when you whisper in a library.

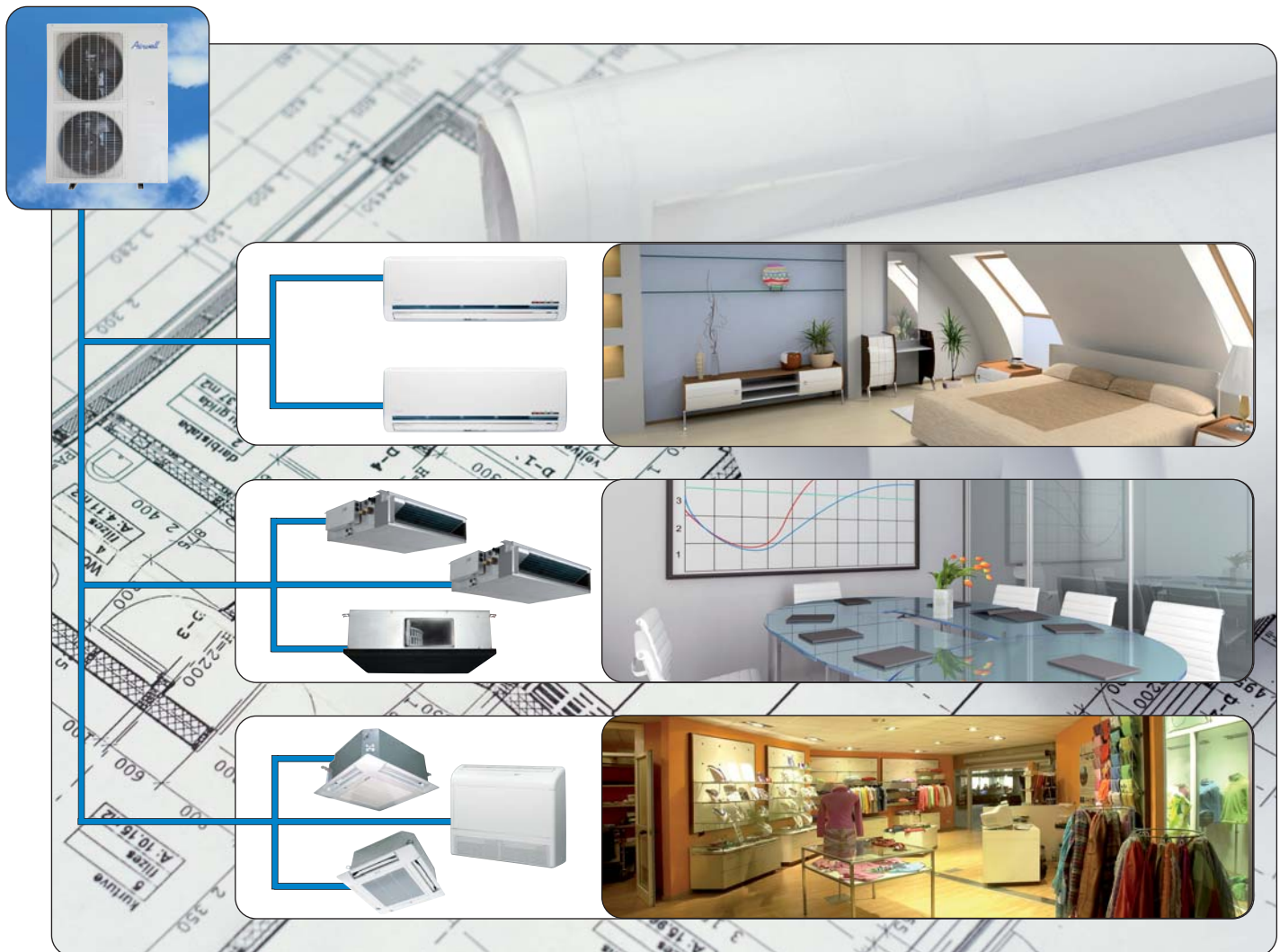

MVi benefits to your building

- Fully customisable air conditioning solution
- Two sizes with nominal capacity of 11,2 and 15,5 kW
- Top class COP up to 4,21
- Up to 9 indoor units to one MVi system
- Up to 200m piping length per system
- Height difference up to 50 m
- Indoor product range from 2.2 kW to 11.0 kW cooling/heating capacity
- 34 different indoor types out of 6 product families
- MVi can be flexible adjusted to each construction stage of the building
- All product sizes can be combined
- Complete range of system controls
- Fully automatic addressing technology

Powerful and Efficient

THE MVi SYSTEM IS DESIGNED TO OPERATE IN PART LOAD CONDITIONS MAINLY, WHICH GUARANTEES MORE EFFICIENCY AND LESS POWER CONSUMPTION COMPARED TO CONVENTIONAL SYSTEMS THAT ARE RUNNING IN AN ON/OFF MODE ONLY.

Max. capacity ratio: **50% -130%**

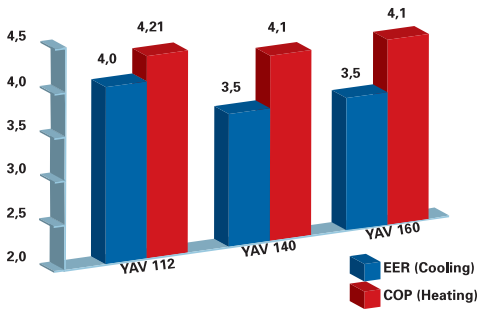
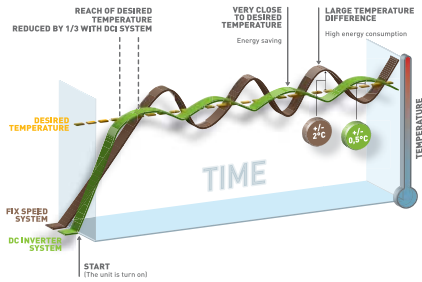
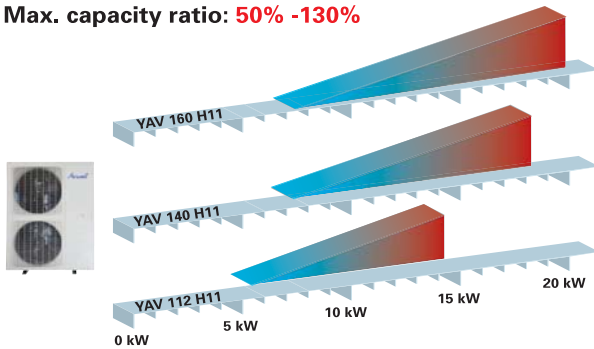

DC INVERTER COMPRESSOR
 The MVi inverter has a capacity range from 50% to 130%. This means that once the inverter starts, the compressor performs at full speed and at 130% of nominal capacity to get the room in a short time to the set room temperature. Once the room set temperature is reached, the compressor speed slows down and adjusts its capacity performance.

The inverter driven compressor can adjust its performance according to the comfort level needed.

DC INVERTER

TOP CLASS EFFICIENCY
 In addition to the DC inverter technology the MVi system is featured with an advanced 480 step electronic expansion valve to precisely amount the refrigerant to each indoor unit allowing individual comfort at any time. The result is that MVi systems achieves remarkable energy efficiency performance (COP greater than 4) whilst offering ultra silent operation, and a compact footprint.

SILENT RUNNING
 The Twin Rotary DC Inverter compressors are fitted across the entire MVi range producing a significant reduction in noise levels and vibrations that guarantees silent running. MVi is the one of quietest on the market.



- ENERGY EFFICIENCY, FEATURES AT ONE GLANCE**
- Partial power shedding via dry contact
 - Unoccupied mode is changing indoor set point while keeping reasonable room temperature
 - Window dry contact avoids cooling when window is open
 - Capacity ration from 50% to 130% according to temperature requirement
 - DC Inverter compressor
 - DC Inverter outdoor and indoor fan motor
 - Sleep mode for reduced capacity during the night

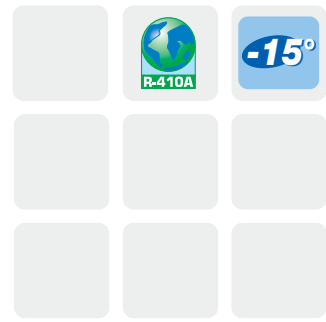

YAV

3 Heat Pump models of 11 kW and 15,5 kW

MVi range is a 2 way heating/cooling solution with variable refrigerant flow using the high performance R410A fluid. This range is unmatched by anything on the market and can operate up to 9 indoor units independently. Using inverter technology, this system can achieve a COP of 4,21 while at the same time offering ultra-silent operation and a very compact footprint. Its great flexibility means that the MVi is equally well adapted to residential applications and to light commercial applications.



PRODUCT ADVANTAGES

- 3 sizes with capacity of 11,2 and 15,5 kW
- Top class COP up to 4,21
- DC Inverter compressor
- DC fan motor
- R410a refrigerant
- Single phase power supply outdoor unit
- Minimum footprint
- Dry contacts (In- & Out-put)
- Advanced pressure control technology to ensure optimum running
- Precise refrigerant flow control using a 480 step Electronic Expansion
- Silence mode reduces outdoor noise level by 5dB(A) during night
- Precharged outdoor unit with additional charge can support maximum 200m tube length
- Operation mode setting via outdoor unit display
- Partial power shedding via dry contact
- Self-diagnosing function
- Easy installation
- 3 Tubing connect directions: Front, side and rear
- Outdoor ambient operation limit -15°C in heating
- Outdoor ambient operation limit -10°C in cooling

Indoor Units			YAV112H	YAV140H	YAV 160H
Cooling	Capacity	kW	11,2	14	15,5
	Power input	kW	2,8	4	4,43
	EER/Energy label		4/A	3,5/A	3,5/A
	Operating limits		-10/46°C Dry Bulb		
Heating	Capacity	kW	12,5	16	18
	Power input	kW	2,97	3,9	4,39
	COP/Energy label		4,21/A	4,1/A	4,1/A
	Operating limits		-15/24°C Dry Bulb		
Indoor unit	Sound pressure (Normal mode)	dB(A)	54	55	56
	Sound pressure (Silent mode)	dB(A)	49	50	51
	Airflow	m ³ /h	6000	6000	6600
	Compressor type		Twin rotary DC Inverter		
	Refrigerant charge	kg	4,5	5,5	6,0
	Number of connectable indoor units		6	8	9
	Dimensions Unit (HxWxD)	mm	1277x950x340	1277x950x340	1227X950X340
	Net Weight	kg	135	135	140
	Part Number		7SP061714	7SP061715	7SP061716
	Power supply 1-230V 50hz	Running Ampere cooling mode	A (1Ph / 3Ph)	12,4/4,6	17,7/6,2
Running Ampere heating mode		A (1Ph / 3Ph)	13,2/4,8	17,3/6,3	-/7,6
Pipe line	Suction pipe diameter	inches	5/8"	5/8"	3/4"
	Liquid pipe diameter	inches	3/8"	3/8"	3/8"

Marks	Contents	Length (m)
L1	Max. tubing length	Actual tubing length
		Equivalent tubing length
ΔL (L2-L3)	Difference between the max. length and the min. length from the NO.1 distribution joint	≤40
I1, I2-I _n	Max. length of each distribution tube	≤30
I1 + I2 + -I _{n-1} + L1	Total max. tubing length including length of each distribution tube (only narrow tubing)	≤200
H1	When outdoor unit is installed higher than indoor unit	≤50
	When outdoor unit is installed lower than indoor unit	≤40
H2	Max. difference between indoor units	≤15

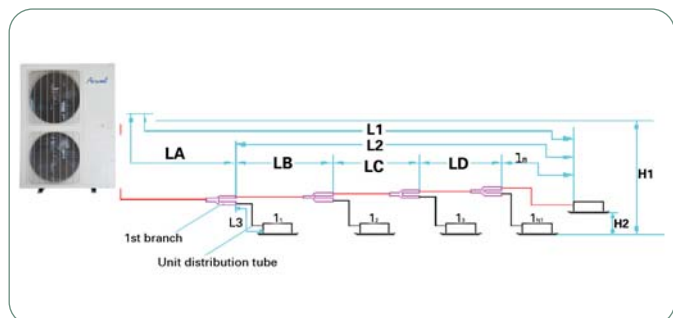

Solution for all indoor application

MVi A COMPLETE RANGE OF INDOOR UNITS



MVi indoor units are available in a wide range of different versions which provides a maximum flexibility. With 34 different product types and sizes from 2,2 to 11kW, MVi indoor range offers solutions to equip any commercial, institutional, or large residential applications. All indoor units are easy to install and designed to provide powerful cooling and heating performance. Different filters and ionizers but also the extremely silent operation of the units (including a night operation mode) offer increased personal comfort. The innovative "I FEEL" function further improves the user comfort as it switches the temperature sensing point from behind the intake grill of the indoor unit, where it is generally located, to the place where the user (the remote control) is physically located. The communication between the remote control and the unit is then done by infra-red signal.

MVi LINE UP OF INDOOR UNITS

Indoor unit		Indoor Unit Capacity									
Type	Design	Model KW	007 2,2	009 2,8	012 3,6	015 4,5	018 5,6	021 6,3	024 7,1	030 9,0	036 11,0
Cassette	CKV		•	•	•		•	•			
	KXV							•	•		
Floor/ Ceiling	SXV		•	•	•		•	•	•	•	
	DLV		•	•	•	•		•	•	•	
	DSV					•	•	•	•		•
Wall Mounted	PNV		•	•	•		•	•	•		

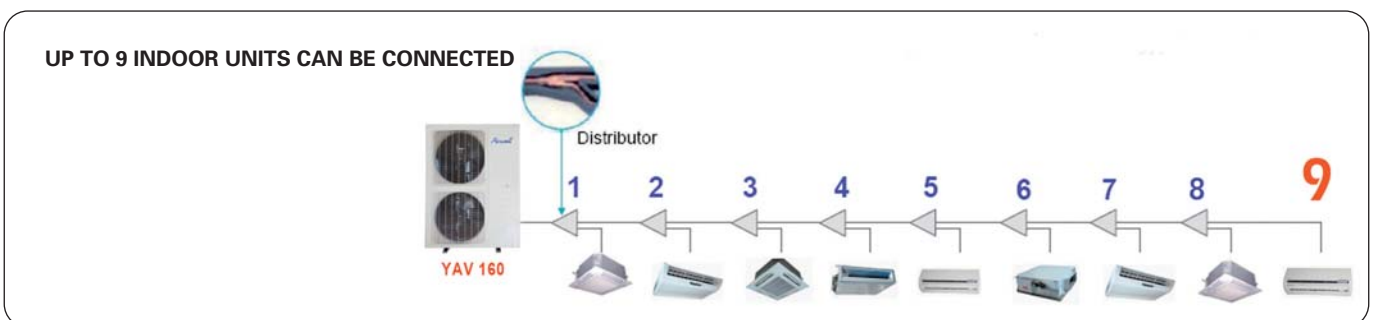



KXV

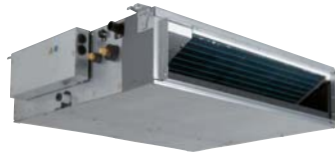

DLV



DSV



GENERAL INDOOR FEATURES

- Product range from 2.2 kW to 11.0 kW cooling/heating capacity
- 34 different indoor units out of 6 product types
- Full variety of indoor families provides max application flexibility
- Up to 9 indoor units to one MVi system
- Each unit has cooling and heating capability
- Flexible combination of different indoor units
- Individual control of each unit type with all control types
- Different filter and ionizer for increased personal comfort
- Focus on installation-friendly units
- Self-Diagnostic function
- Automatic restart after power failure
- All units following latest state of the art design
- All units are noise-optimised and run very silent
- "I feel" function optimizes personal comfort
- Easy and quick access to all maintenance components
- Night operation mode decreases further the noise level
- Three fan levels and auto louver function for quick room comfort
- Fresh air inlet (in selected units)



WALL MOUNTED

PNV

6 Heat Pump models
From 2,5 kW to 7 kW

INDOOR UNIT **PNV 009-012**



RC7



PRODUCT ADVANTAGES

- Horizontal and vertical louver swing
- Auto air flow adjustment
- Very low noise level (29dB(A) at size 007
- Bended indoor coil with treated aluminium fins and coating for improved efficiency
- 5 refrigerant pipes optional directions

- Water condensate tray with two optional drain connections
- Dry contact for clock or power shedding functions (configurable)
- Optimal efficiency : Class A energy label
- Electronic regulation and programming
- High efficiency filtration (Bi-Polar Ionizer, Electrostatic filter)
- Infrared remote control (optional)

INDOOR UNIT **PNV 018-021**



	Indoor Units		PNV 007	PNV 009	PNV 012	PNV 015	PNV 018	PNV 021
Cooling	Capacity	kW	2,2	2,8	3,6	4,5	5,6	6,3
	Input power	kW	0,011	0,014	0,016	0,019	0,026	0,031
Heating	Capacity	kW	2,5	3,2	4	5	6,3	7
	Input power	kW	0,012	0,015	0,017	0,022	0,03	0,035
Indoor unit	Sound pressure level 1 mt	dB(A)	29/31/37	34/35/39	35/37/40	29/31/34	32/35/40	34/39/43
	Sound power level	dB(A)	41/43/48	46/47/50	47/49/52	41/43/46	44/48/52	46/51/56
	Airflow	m ³ /h	340/380/420	340/380/470	350/420/500	400/470/580	500/610/700	570/680/790
	Dehumidification	l/h	1	1,5	1,5	2	2	2,5
	Dimensions (WxDxH)	mm	810x210x285	810x210x285	810x210x285	1060x221x295	1060x221x295	1060x221x295
	Weight	kg	10	11,5	11,5	14,5	14,5	14,5
	Part Number			7SP022772	7SP022773	7SP022774	7SP022775	7SP022776
Pipe line	Suction pipe diameter	inches	1/2"	1/2"	1/2"	1/2"	1/2"	5/8"
	Liquid pipe diameter	inches	1/4"	1/4"	1/4"	1/4"	1/4"	3/8"

FLOOR CEILING

SXV

7 Heat Pump models
From 2,5 kW to 8 kW

INDOOR UNIT **SXV 007-012/015-24**



Horizontal or vertical unit mounting



Possibility of air conditioning 2 separate rooms with a single unit



PRODUCT ADVANTAGES

- Elegant and modern design
- Two types of casing with very slim profile of 190 mm for all models
- Space for external drain water pump
- Easy access to all electrical components
- Self diagnostic LED lighting
- Diagnostic through LWC controller (optional)
- Low noise level
- Dual automatic treated air sweeping
- Possibility to air condition two separated rooms with a single unit
- Under ceiling or floor mounted installation
- DC fan motor for increased efficiency
- Infrared remote control (optional)

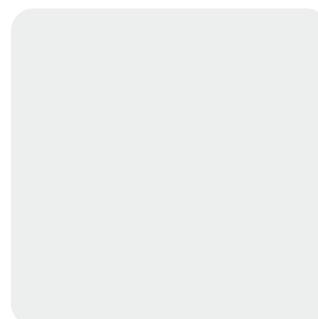

Indoor Units			SXV 007	SXV 009	SXV 012	SXV 015	SXV 018	SXV 021	SXV 024
Cooling	Capacity	kW	2,2	2,8	3,6	4,5	5,5	6,3	7,1
	Input power	kW	0,02	0,021	0,023	0,037	0,07	0,082	0,09
Heating	Capacity	kW	2,5	3,2	4	5	6,3	7	8
	Input power	kW	0,022	0,024	0,026	0,04	0,075	0,089	0,096
Indoor unit	Sound pressure level 1 mt	dB(A)	34/37/42	34/37/42	35/39/44	37/40/42	45/48/52	46/50/53	47/51/54
	Sound power level	dB(A)	46/49/54	45/48/53	47/51/56	49/52/54	57/60/64	57/62/65	59/63/66
	Airflow	m ³ /h	290/350/410	290/350/410	300/360/440	500/590/630	730/820/910	730/830/980	730/860/1000
	Dehumidification	l/h	1	1,5	1,5	2	2	2,5	2,5
	Dimensions (WxDxH)	mm	820 x 190 x 630	820 x 190 x 630	820 x 190 x 630	1200 x 190 x 630	1200 x 190 x 630	1200 x 190 x 630	1200 x 190 x 630
	Weight	kg	20	22	22	28	28	30	30
Part Number			7SP012167	7SP012168	7SP012169	7SP012170	7SP012171	7SP012172	7SP012173
Pipe line	Suction pipe diameter	inches	1/2"	1/2"	1/2"	1/2"	1/2"	5/8"	5/8"
	Liquid pipe diameter	inches	1/4"	1/4"	1/4"	1/4"	1/4"	3/8"	3/8"

CASSETTE

CKV

5 Heat Pump models
From 2,5 kW to 6,3 kW

INDOOR UNIT CKV 007/018



Panel 625x625



FRESH AIR INTAKE

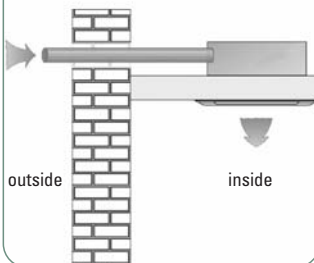

PRODUCT ADVANTAGES

- 600 x 600 mm format
- Built-in depth: 230 mm (007/009/012)
- Innovative features with elegant design
- Air distribution to an adjacent room
- Four motorized air distribution flaps
- 6 selectable louver positions plus automatic and swing
- High efficiency filtration
- Very low noise level (31dB(A) at size 007)
- Designed for integration in suspended ceilings
- Simplified installation and maintenance
- Integrated condensate pump with a lift of 1 m max.
- Electronic regulation and programming
- Condensing water over-flow protection as standard
- Self diagnostic LED lighting for ease of maintenance
- Diagnostic through LWC controller (optional)
- 2 panels optional available (Hard and suspended ceiling)
- Fresh air intake
- DC fan motor for increased efficiency
- Infrared remote control (optional)



Panel 725x725

AIR CONDITIONING OF AN ADJACENT ROOM

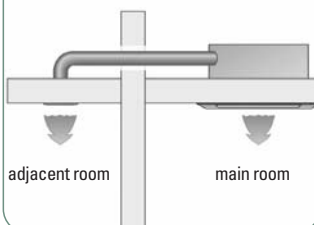

RC7



	Indoor Units	CKV 007	CKV 009	CKV 012	CKV 015	CKV 018
Cooling	Capacity	kW 2,2	2,8	3,6	4,5	5,6
	Input power	kW 0,021	0,024	0,03	0,042	0,053
Heating	Capacity	kW 2,5	3,2	4	5	6,3
	Input power	kW 0,022	0,025	0,031	0,042	0,053
Indoor unit	Sound pressure level 1 mt	dB(A) 31/32/33	32/33/34	34/35/36	35/37/38	38/41/42
	Sound power level	dB(A) 43/44/45	44/45/46	45/47/48	47/49/51	50/53/54
	Airflow	m ³ /h 280/320/370	310/370/430	370/440/520	430/520/630	570/640/720
	Dehumidification	l/h 1	1,5	1,5	2	2
	Dimensions (WxDxH)	mm 578x219x578	578x219x578	578x219x578	578x219x578	578x219x578
	Part Number frame 625x40x625*	7ACVF0484	7ACVF0484	7ACVF0484	7ACVF0484	7ACVF0484
	Weight frame 625x40x625	kg 2,2	2,2	2,2	2,2	2,2
	Part Number frame 725x40x725*	7ACVF0483	7ACVF0483	7ACVF0483	7ACVF0483	7ACVF0483
	Weight frame 725x40x725	kg 2,7	2,7	2,7	2,7	2,7
	Weight	kg 12,9	12,9	12,9	15,2	15,2
Pipe line	Part Number	7SP042182	7SP042183	7SP042184	7SP042185	7SP042186
	Suction pipe diameter	inches 1/2"	1/2"	1/2"	1/2"	1/2"
	Liquid pipe diameter	inches 1/4"	1/4"	1/4"	1/4"	1/4"

* The panel is separated from unit and not delivered on the same box. CKV is delivered without panel.
For each order, decoration panel must be ordered according to the installation situation.

CASSETTE

KXV

4 Heat Pump models
From 7 kW to 12,5 kW

INDOOR UNIT **KXV 021/036**



RC7



FRESH AIR INTAKE

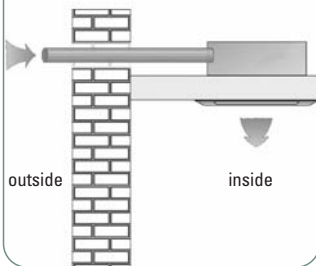

PRODUCT ADVANTAGES

- 900 x 900 mm format
- Built-in depth: 230 mm (021/024)
- Innovative features with elegant design
- Air distribution to an adjacent room
- Fresh air inlet
- Four motorized air distribution flaps
- High efficiency filtration
- Simplified installation and maintenance
- Integrated condensate pump with a lift of 1.2 m
- Condensing water over-flow protection as standard
- Self diagnostic LED lighting for ease of maintenance
- Diagnostic through LWC controller (optional)
- Optimal electronic regulation and programming
- Infrared remote control (optional)

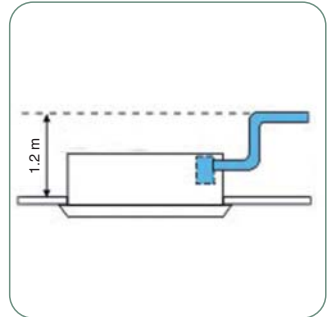

AIR CONDITIONING OF AN ADJACENT ROOM

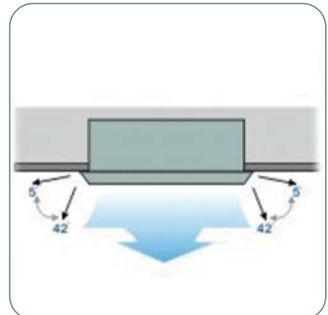
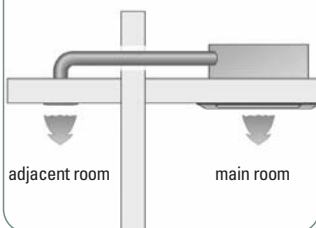

Indoor Units			KXV 021	KXV 024	KXV 030	KXV 036
Cooling	Capacity	kW	6,3	7,1	9	11
	Input power	kW	0,049	0,054	0,094	0,133
Heating	Capacity	kW	7	8	10	12,5
	Input power	kW	0,049	0,054	0,096	0,136
Indoor unit	Sound pressure level to 1 m	dB(A)	41/43/46	42/44/46	45/47/49	47/50/53
	Sound power level	dB(A)	53/55/58	54/56/58	56/59/61	59/62/65
	Airflow	m ³ /h	880/980/1080	910/1000/1140	1250/1370/1490	1360/1510/1650
	Dehumidification	l/h	2,5	2,5	3	3
	Dimensions (WxDxH)	mm	840x230x840	840x230x840	840x300x840	840x300x840
	Weight frame	kg	5,5	5,5	5,5	5,5
	Dimension frame		950x30x950	950x30x950	950x30x950	950x30x950
	Part Number frame*	kg	7ACVF0529	7ACVF0529	7ACVF0529	7ACVF0529
	Weight	kg	24	24	29	29
	Part Number		7SP042204	7SP042205	7SP042206	7SP042207
Pipe line	Suction pipe diameter	inches	5/8"	5/8"	5/8"	5/8"
	Liquid pipe diameter	inches	3/8"	3/8"	3/8"	3/8"

* The panel is separated from unit and not delivered on the same box. KXV is delivered without panel.
For each order, decoration panel must be ordered.

DUCTED DLV

7 Heat Pump models
From 2,5 kW to 8 kW

INDOOR UNIT DLV 007/024

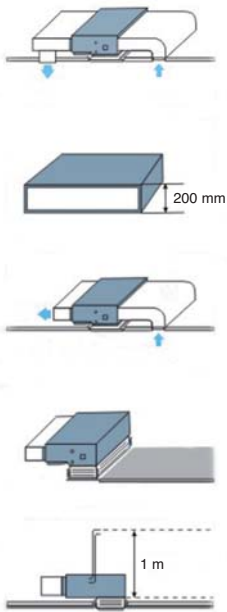

PRODUCT ADVANTAGES

- Very slim profile 200mm for all model sizes
- Integrated condensate pump with a lift of 1 m max
- Return air via bottom or backside of the unit
- Unoccupied mode
- Condensing water over-flow protection as standard
- Easy access to all electrical components
- Very low noise level (27/30dB(A))
- Self diagnostic LED lighting for easy maintenance (with Infrared receiver only)
- Diagnostic through LWC controller (optional)
- Air distribution / air intake plenums available in accessory
- Infrared remote control (optional)

RC7



	Indoor Units	DLV 007	DLV 009	DLV 012	DLV 015	DLV 018	DLV 021	DLV 024
Cooling	Capacity	kW 2,2	2,8	3,6	4,5	5,5	6,3	7,1
	Input power	kW 0,042	0,046	0,051	0,057	0,083	0,093	0,103
Heating	Capacity	kW 2,5	3,2	4	5	6,3	7	8
	Input power	kW 0,043	0,048	0,053	0,059	0,087	0,096	0,107
Indoor unit	Sound pressure level to 1 m	dB(A) 27/28/30	28/29/31	30/32/34	30/32/34	28/32/33	28/32/34	33/35/40
	Sound power level	dB(A) 39/40/42	40/41/43	42/44/46	42/44/46	40/44/45	40/44/46	45/47/52
	Static pressure	Pa 10	10	10	10	10	10	10
	Airflow	m³/h 230/340/430	340/430/480	480/570/660	600/690/760	730/870/1000	730/870/1050	920/1050/1300
	Dehumidification	l/h 1	1,5	1,5	2	2	2,5	2,5
	Dimensions (WxDxH)	mm 750x200x630	750x200x630	750x200x630	750x200x630	1050x200x630	1050x200x630	1050x200x630
	Weight	kg 20	21	21	22	24	25	25
	Part Number	7SP032098	7SP032099	7SP032100	7SP032101	7SP032102	7SP032103	7SP032104
	Part Number Plenum*	7ACVF0516	7ACVF0516	7ACVF0516	7ACVF0516	7ACVF0516	7ACVF0517	7ACVF0517
	Pipe line	Suction pipe diameter	inches 1/2"	1/2"	1/2"	1/2"	1/2"	5/8"
Liquid pipe diameter		inches 1/4"	1/4"	1/4"	1/4"	1/4"	3/8"	3/8"

* In accessory

DUCTED DSV

5 Heat Pump models
From 6,3 kW to 12,5 kW

INDOOR UNIT **DSV 018/036**



PRODUCT ADVANTAGES

- Low built-in height: 260 mm (sizes 018 to 024)
- Easy installation of optional water pump
- Plastic fan and housing for improved sound level
- Very low noise level 31dB(A) at size 018
- Infrared remote control regulation (optional)
- Diagnostic through LWC controller (optional)
- Electronic regulation and programming
- Self diagnostic LED lighting for easy maintenance (with Infrared receiver only)
- Air distribution / air intake plenums available as accessory
- Easy access to all electrical components
- Condensing water over-flow protection as standard
- Painted drain pan designed for gravity evacuation
- Infrared remote control (optional)

RC7

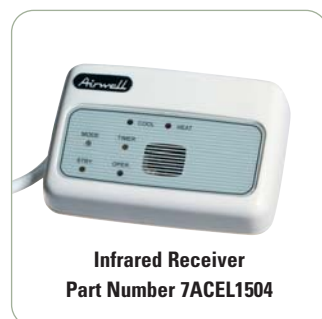

Infrared Receiver
Part Number 7ACEL1504

Indoor Units		DSV 018	DSV 021	DSV 024	DSV 030	DSV 036
Cooling	Capacity	kW 5,6	6,3	7,1	9	11
	Input power	kW 0,139	0,154	0,171	0,218	0,242
Heating	Capacity	kW 6,3	7	8	10	12,5
	Input power	kW 0,144	0,16	0,178	0,224	0,249
Indoor unit	Sound pressure level to 1 m	dB(A) 31/32/33	32/33/34	39/40/44	43/44/46	44/45/47
	Sound power level	dB(A) 43/44/45	44/45/46	51/52/56	55/56/58	56/57/59
	Static pressure	Pa 25	25	25	37	37
	Airflow	m ³ /h 570/740/900	660/760/900	980/1190/1400	1260/1430/1600	1360/1540/1700
	Dehumidification	l/h 2	2,5	2,5	3	3
	Dimensions (WxDxH)	mm 749x790x256	749x790x256	749x790x256	816x854x297	816x854x297
	Weight	kg 29	31	31	33	33
	Part Number	7SP032106	7SP032107	7SP032108	7SP032109	7SP032110
	Part Number Plenum*	7ACVF0317	7ACVF0317	7ACVF0317	7ACVF0318	7ACVF0318
Pipe line	Suction pipe diameter	inches 1/2"	5/8"	5/8"	5/8"	5/8"
	Liquid pipe diameter	inches 1/4"	3/8"	3/8"	3/8"	3/8"

* In accessory

EASY AND FLEXIBLE CONTROL

MVi stands also for simplify set up and control conditions. For example, a fully automatic addressing technology of the indoor units allows saving time and money for installers and users. Furthermore, four different start-up modes allow setting the system according to specific customer requirements and contributes to energy savings. In case a dedicated adjustment of individual zoning is not needed, the MVi system are advised to select the default start-up mode where the first indoor unit which starts operating will define the system mode. Through manual settings, the system can be forced to cool or heat via an outdoor unit user interface (a switch connected to a dry contact). The automatic start-up selection according to the outdoor temperature may contribute to energy savings. And last but not least a master indoor unit can be defined which will determine the operating mode of the full system.

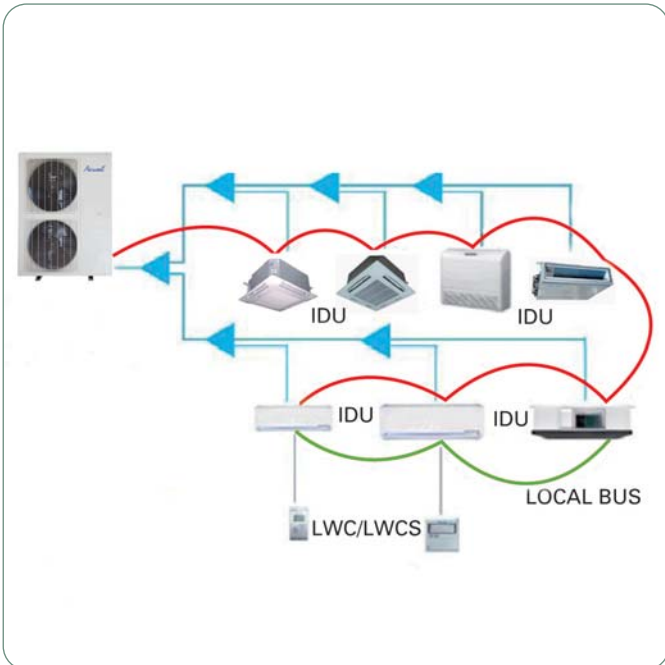

Monitoring

MVi features are completed by its user friendly and time saving monitoring options. Via a communication bus as well as online monitoring, the complete system can be controlled permanently. Parameters can be changed if required and faults can be diagnosed and analysed without any loss of time via a PC, the outdoor unit display panel and the LWC & LWCS controller. Operational parameters can be recorded as files and visualised by means of customised graphs will determine the operating mode of the full system.

Remote controllers table list

Operations system	Individual control systems	Centralized control systems		Receiver
Needs	Indoor unit wireless remote controller	Operation with various function from center station	Simple edition of LWC	For RC use in ducted unit
External appearance				
Model name	RC7I-1	LWC	LWCS	IRD
Number of indoor units which can be controlled	No limit	1~16 group, up to 16 units	1~16 group, up to 16 units	1 unit
Use limitations	The remote length limit to 8 m	The wiring length limit to 100 m	The wiring length limit to 100 m	The wiring length limit to 8 m
Connectable indoor unit	7 series	7 series	7 series	2 kinds of Ducted series
Function	ON/OFF	✓	✓	✓
	Operation Mode		✓	✓
	Temperature setting	✓	✓	✓
	Fan speed selection	✓	✓	✓
	Ioniser	✓	✓	-
	Electrostatic filter (ESF)	✓	✓	-
	Fresh air	-	✓	-
	Ventilation mode (HRV unit)	-	✓	-
	Vertical Louver	✓	✓	✓
	Horizontal Louver	✓	✓	-
	Sleep function	✓	✓	-
	I-feel function	✓	✓	✓
	I-feel display	✓	-	-

REMOTE CONTROL

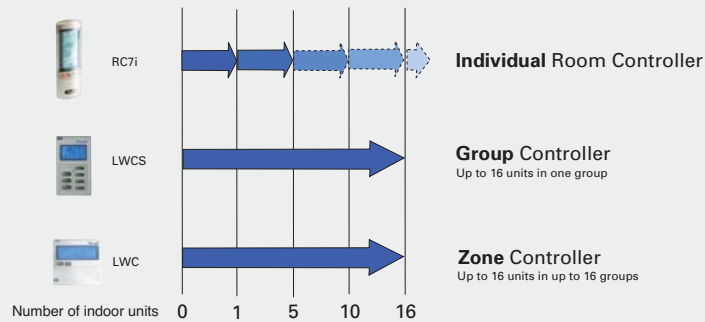

It is quite usual that not all rooms are in use at the same time and it makes no sense to cool rooms which are not in use. The LWC controller is able to manage this fact with its programming functions. The group and zoning function manages individual time periods per hour, day and weeks so that unoccupied time slots like lunchtime, night time, weekends and holidays are in optimised energy saving mode.

The wired controllers are connected with just two non-polar wires which reduce the occurrence of miss wiring. Not every room needs to have the same temperature requirement at the same time. The MVi controller has built-in intelligence to manage each room of a system individually.

IR REMOTE CONTROL

Main Features

- Basic functions (ON/OFF, Mode...)
- Independent operation of ventilation
- «I feel» comfort setting and display
- Comfort setting
 - Vertical & horizontal air flow direction adjustment
 - Electrostatic filter - Ionizer
 - Sleep function - Clock/Time setting - Lock bottom



Part Number 7ACEL1507

LWCS LOCAL WIRED CONTROL (SIMPLE)

Main Functions

- Basic functions (ON/OFF, Mode...)
- Comfort setting
 - Vertical air flow direction adjustment. - «I feel» setting
- Control of up to 16 units within 1 group
- Operation mode change over
- Technician mode for check malfunctions
- Technician mode for read/write user address
- Wiring length up to 100m



Part Number 7ACEL1503

LWC LOCAL WIRED CONTROL

Main Functions

- Basic functions (ON/OFF, Mode...)
- Comfort setting
 - Vertical & horizontal air flow direction adjustment
 - «I feel» setting - Electrostatic filter
 - Ionizer - Sleep
- Control of up to 16 units within 1 to 16 groups
- Holiday function
- Weekly timer program
- Daily timer program with 5 scheduled timer actions per day
- Wiring length up to 100m



Part Number 7ACEL1502

The logo for Airwell, featuring the word "Airwell" in a white, italicized, sans-serif font on a blue background.

www.airwell.com
contact@airwell-group.com

Airwell Group

1, Bis Avenue du 8 mai 45
Saint Quentin en Yvelines
78284 GUYANCOURT
France
Tel. +33 (0)139 44 78 00
Fax +33 (0)139 44 65 17