

INSTALLATION INSTRUCTIONS

ENGLISH

INSTRUCTIONS D'INSTALLATION

FRANÇAIS

MONTAGEANLEITUNG

DEUTSCH

MANUALE D'INSTALLAZIONE

ITALIANO

INSTRUCCIONES DE INSTALACIÓN

ESPAÑOL

ИНСТРУКЦИИ ПО УСТАНОВКЕ

РУССКИЙ

Airwell

INSTALLATION INSTRUCTIONS

ENGLISH

1. LOCATION OF OUTDOOR UNIT
2. ELECTRICAL CONNECTION BETWEEN INDOOR AND OUTDOOR UNIT
3. INSTALLATION/SERVICE TOOLS (ONLY FOR R410A PRODUCT)
4. REFRIGERANT TUBING
5. FEATURES SETUP
6. INSTALLATION TEST MISWIRING CHECK
7. FINAL TASKS

The appliance shall not be installed in the laundry.

NOTE: This manual is for Multi split applications only.
For indoor units installation, please refer to the installation manual supplied within the indoor unit package.

INSTALLATION INSTRUCTIONS FOR DCI SPLIT WALL MOUNTED AIR CONDITIONER

1

LOCATION OF OUTDOOR UNIT

Select the location considering the following:

OUTDOOR UNIT

1. The location must allow easy servicing and provide good air circulation as shown in fig 4.
2. The unit may be suspended from a wall by a bracket (Optional) or located in a free standing position on the floor (preferably slightly elevated).
3. If the unit is suspended, ensure that the bracket is firmly connected and the wall is strong enough to withstand vibrations.
4. Unit location should not disturb neighbors with noise or exhaust air stream.
5. Place the mounting pads under the unit legs.
6. Refer to figure 3 for allowed installation distances.
7. When the unit is installed on a wall, install the drain connector hose and drain plug as shown in fig 1 and fig 2.

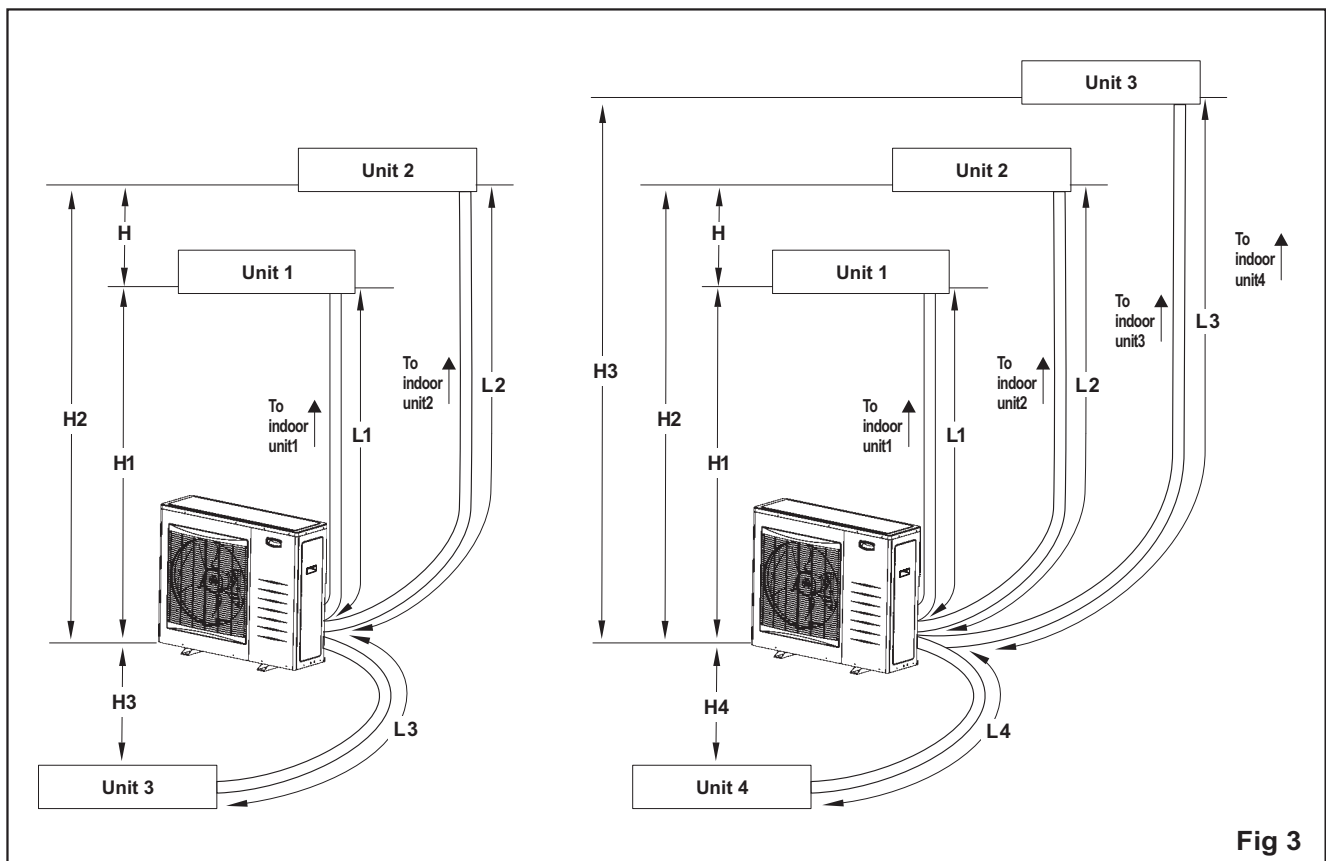

Fig 3

NOTES:

Quattro: $L1 + L2 + L3 + L4 \leq 70m$

Trio: $L1 + L2 + L3 \leq 50m$

$L1, L2, L3, L4 \leq 25m$

$H1, H2, H3, H4 \leq 15m$

$H \leq 15m$.

No additional charge is required.

Fig.1
1.Bottom of outdoor unit
2.Drain connector

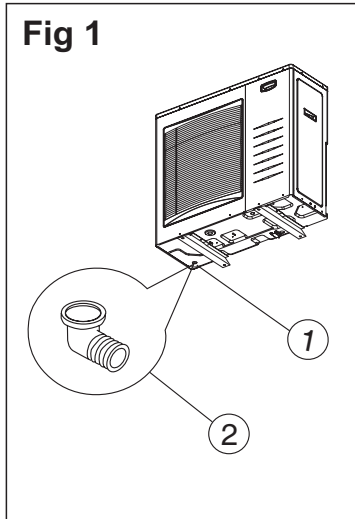
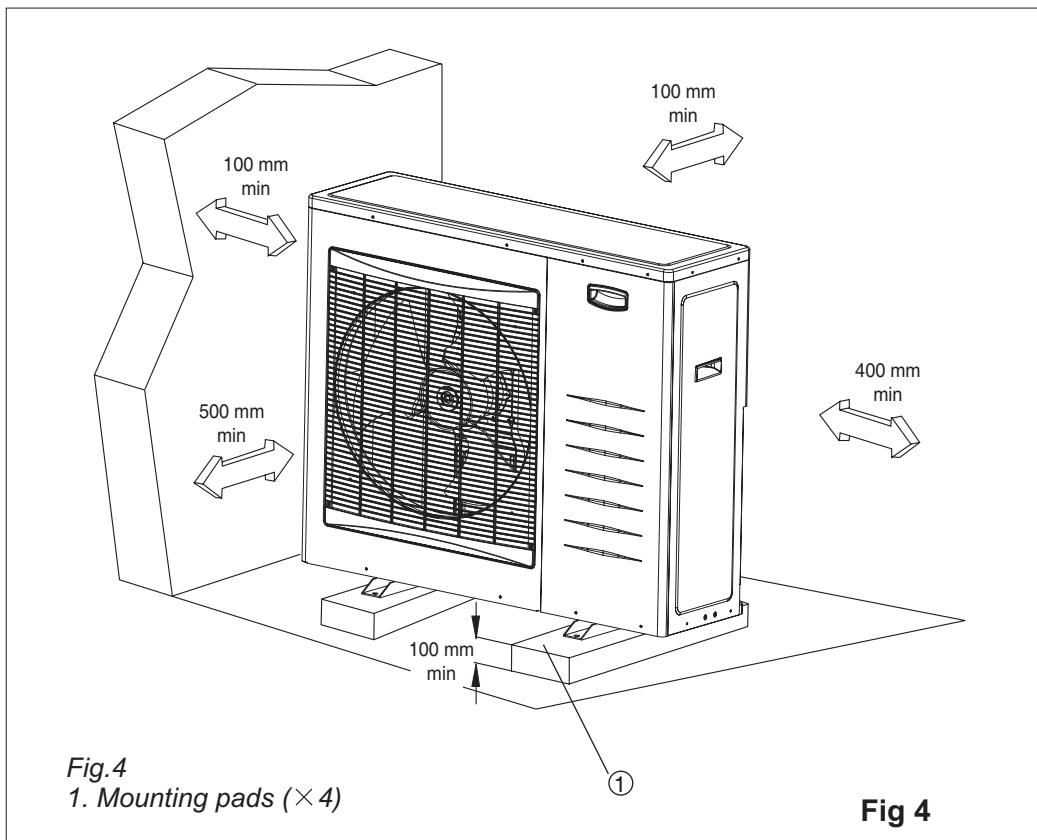
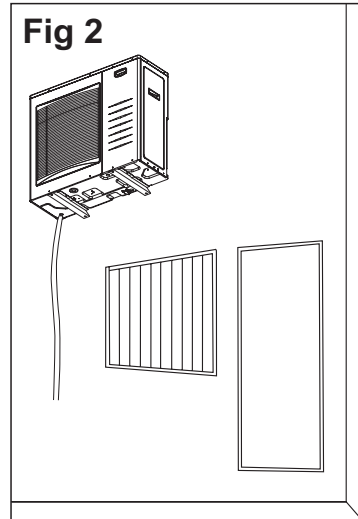

Fig.2
Drain installation
Example



ELECTRICAL CONNECTION BETWEEN OUTDOOR AND INDOOR UNIT

ELECTRICAL REQUIREMENTS

Electrical wiring and connections should be made by qualified electricians and in accordance with local electrical codes and regulation. The air conditioner units must be grounded.

The air conditioner units must be connected to an adequate power outlet from a separate branch circuit protected by a time delay circuit breaker, as specified on unit's nameplate.

Voltage should not vary beyond $\pm 10\%$ of the rated voltage.

1. Remove the power supply cable that is connected to the indoor unit!
2. To connect the indoor units to the outdoor unit, use the following electrical cables.

Electrical connections:

Power input cable: 3 wires \times 2.5 mm²

Cable between indoor and outdoor units: 4 wires \times 1.5 mm²

3. Prepare the cable ends for the power input and for the cables between outdoor and indoor units as shown in figure 6a and 6b respectively.
4. Connect the cable ends to the terminals of the indoor and outdoor units, as shown in fig.7. Please select corresponding connection according to the different indoor units.
5. Secure the multiple wire power cable with the cable clamps.

Fig.5

1. Terminal
2. Cable clamp

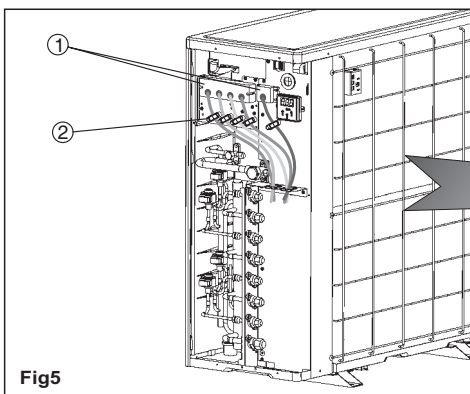

NOTES:

The wire color code can be selected by the installer.

• Power input cable

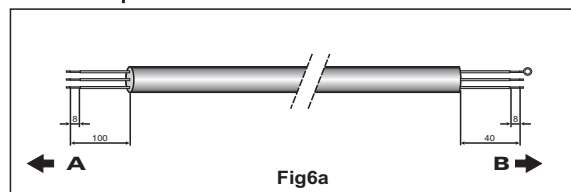

• Cable between indoor and outdoor units

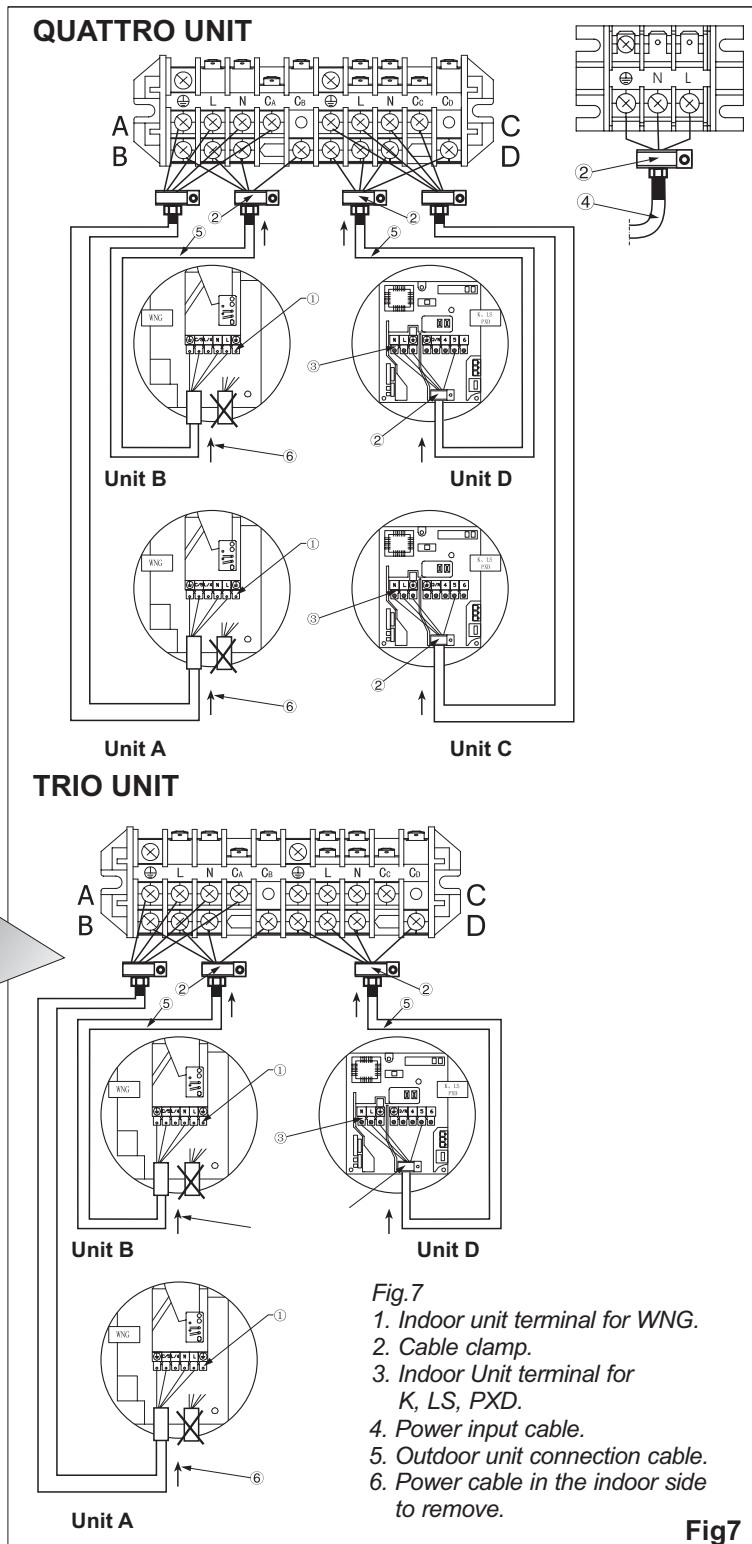
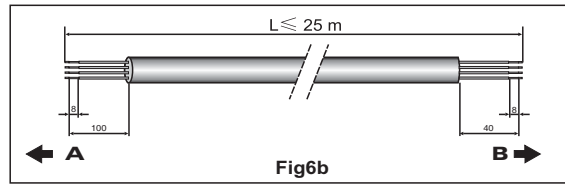

Fig.7

1. Indoor unit terminal for WNG.
2. Cable clamp.
3. Indoor Unit terminal for K, LS, PXD.
4. Power input cable.
5. Outdoor unit connection cable.
6. Power cable in the indoor side to remove.

Fig7

INSTALLATION/SERVICE TOOLS (ONLY FOR R410A PRODUCT)

CAUTION

New Refrigerant Air Conditioner Installation

THIS AIR CONDITIONER ADOPTS THE NEW HFC REFRIGERANT (R410A) WHICH DOES NOT DESTROY OZONE LAYER.

R410A refrigerant is apt to be affected by impurities such as water, oxidizing membrane, and oils because the working pressure of R410A refrigerant is approx. 1.6 times of refrigerant R22. Accompanied with the adoption of the new refrigerant, the refrigeration machine oil has also been changed. Therefore, during installation work, be sure that water, dust, former refrigerant, or refrigeration machine oil does not enter into the new type refrigerant R410A air conditioner circuit.

The system must not be left open to the atmosphere for any reason for any period of time as the systems oil quickly absorbs moisture and will contaminate and damage the system.

A refrigerant liquid line drier is recommended.







To prevent mixing of refrigerant or refrigerating machine oil, the sizes of connecting sections of charging port on main unit and installation tools are different from those used for the conventional refrigerant units. Accordingly, special tools are required for the new refrigerant (R410A) units. For connecting pipes, use new and clean piping materials with high pressure fittings made for R410A only, so that water and/or dust does not enter. Moreover, do not use the existing piping because there are some problems with pressure fittings and possible impurities in existing piping.

Changes in the product and components

In air conditioners using R410A, in order to prevent any other refrigerant from being accidentally charged, the service port diameter size of the outdoor unit control valve (3 way valve) has been changed. (1/2 UNF 20 threads per inch)

- In order to increase the pressure resisting strength of the refrigerant piping, flare processing diameter and opposing flare nuts sizes have been changed. (for copper pipes with nominal dimensions 1/2 and 5/8)

New tools for R410A

New tools for R410A	Applicable to R22 model	Changes
Gauge manifold	×	 As the working pressure is high, it is impossible to measure the working pressure using conventional gauges. In order to prevent any other refrigerant from being charged, the port diameters have been changed.
Charge hose	×	 In order to increase pressure resisting strength, hose materials and port sizes have been changed (to 1/2 UNF 20 threads per inch). When purchasing a charge hose, be sure to confirm the port size.
Electronic balance for refrigerant charging	○	 As working pressure is high and gasification speed is fast, it is difficult to read the indicated value by means of charging cylinder, as air bubbles occur.
Torque wrench (nominal dia. 1/2, 5/8)	×	 The size of opposing flare nuts have been increased. Incidentally, a common wrench is used for nominal diameters 1/4 and 3/8.
Flare tool (clutch type)	○	 By increasing the clamp bar's receiving hole size, strength of spring in the tool has been improved.
Gauge for projection adjustment	—	Used when flare is made by using conventional flare tool.
Vacuum pump adapter	○	 Connected to conventional vacuum pump. It is necessary to use an adapter to prevent vacuum pump oil from flowing back into the charge hose. The charge hose connecting part has two ports -- one for conventional refrigerant (7/16 UNF 20 threads per inch) and one for R410A. If the vacuum pump oil (mineral) mixes with R410A a sludge may occur and damage the equipment.
Gas leakage detector	×	 Exclusive for HFC refrigerant.

- Incidentally, the "refrigerant cylinder" comes with the refrigerant designation (R410A) and protector coating in the U.S's ARI specified rose color (ARI color code: PMS 507).
- Also, the "charge port and packing for refrigerant cylinder" requires 1/2 UNF 20 threads per inch corresponding to the charge hose's port size.

REFRIGERANT TUBING

CONNECT THE INDOOR TO THE OUTDOOR UNIT

The indoor unit contains a small quantity of nitrogen. Do not unscrew the nuts from the unit until you are ready to connect the tubing. The outdoor unit is supplied with sufficient refrigerant charge (R410A). Refer to outdoor unit nameplate.

To prevent crushing, bend tubes using a bending tool.

NOTE: Use refrigeration R410A type copper tubing only.

1. Open the valve cover.
2. Use tubing diameter that corresponds to the tubing diameter of the indoor and outdoor units. Note that the liquid and suction tubes have different diameters. (See tube size, torque tightening table.)
3. Place flare nuts on tube ends before preparing them with a flaring tool. Use the flare nuts that are mounted on the supplied outdoor and indoor units.
4. Connect the all ends of the tubing to the indoor and outdoor units. Notice the sign. All ends should correspond one by one.
5. Insulate each tube separately, and their unions, with at least 6 mm thick of insulation. Wrap the refrigerant tubing, drain hose and electric cables together with a vinyl tape (UV protected).

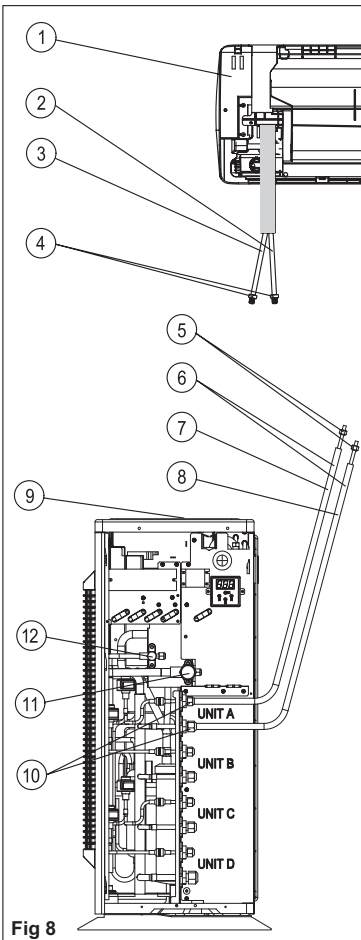

Caution!
When unscrewing the valve caps, do not stand in front of them or the spindles at any time, as the system is under pressure.

Fig.8
1.INDOOR UNIT
2.Liquid tube (small dia.)
3.Suction tube (large dia.)
4.Plugs
5.Flare nuts
6.Tubing between units
7.Suction tube
8.Liquid tube
9.OUTDOOR UNIT
10.Flare nuts
11.Suction valve (larger)
12.Liquid valve (small)

NOTE: 1. For trio unit use connections A, B and D
2. For large indoor unit of 5.0KW Use the lower connection (unit D)

Tightening torques of unions and valve caps:

TUBE SIZE	TORQUE
Liquid line 1/4"	15-20 N.M.
Suction line 3/8"	30-35 N.M.
Suction line 1/2"	50-54 N.M.
Suction line 5/8"	75-78 N.M.

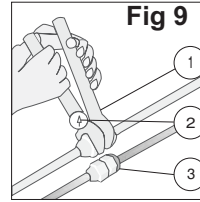

Fig.9
1.Wrench
2.Torque wrench
3.Union

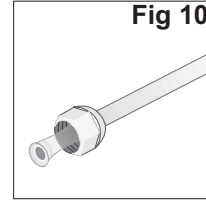

Fig.10
To prevent refrigerant leakage, coat the flared surface with refrigeration oil

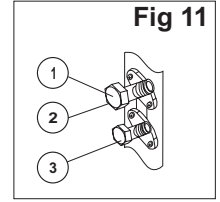

Fig.11
1.Suction valve
2.Service port
3.Liquid valve

EVACUATION OF THE REFRIGERATION TUBES AND THE INDOOR UNIT

After connecting the unions of the indoor and outdoor units, evacuate the air from the tubes and indoor unit as follows:

1. Connect the charging hoses with a push pin to the low and high sides of the charging set and the service ports of the suction and liquid valves.
Be sure to connect the end of the charging hose with the push pin to the service ports.
2. Connect the center hose of the charging set to a vacuum pump.
3. Open Fully the low and high pressure sides of the manifold gauge valves.
4. Turn on the vacuum pump. Perform evacuating for at least 30 minutes and than confirm that the needle in the gauge moves from 0 MPa (0cm Hg) to -0.1 MPa (-76cm Hg).
5. Close the valves of the low and high sides of the charging set and turn off the vacuum pump. After few minutes, if the gauge needle has moved, there is a leak which must be found and repaired before moving to the next stage.
6. Disconnect the charging hose from the vacuum pump and from the service ports of the suction and liquid valves.
7. Tighten the service port caps of suction and liquid valves.
8. Remove the valve caps from all valves, and open them using a hexagonal Allen wrench.
9. Securely tighten the caps onto all of the valves.
10. Check for gas leaks from all the connecting position. Test with electronic leak detector or with a sponge immersed in soapy water for bubbles.

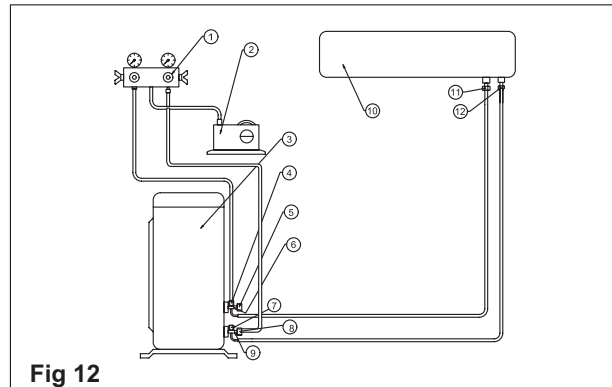

Fig.12
1. Charging set
2. Vacuum pump
3. OUTDOOR UNIT
4. Service valve
5. Cap
6. Suction valve
7. Service valve
8. Cap
9. Liquid valve
10. INDOOR UNIT
11. Suction flare connection
12. Liquid flare connection

FEATURES SETUP

5.1. Display Board general description

The display board serves as interface between the installer/technician to the A/C unit.

- Scroll ("Up" & "Down") - used to scroll between options (up and down)
- Select - used to select an option.
- Escape ("Esc") - Will go up one level in the menu

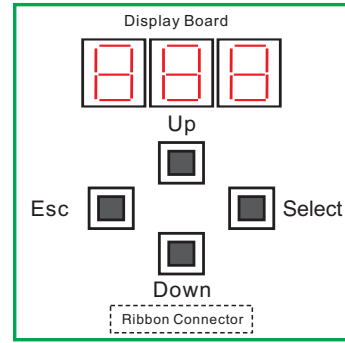

5.2. Thermal mode setting

There are 2 options for the thermal mode setting of the unit, either to set the mode by the indoor units selection or by forcing the mode to cool or heat.

5.2.1. Priority room setting

If an IDU is defined as a priority unit, the operational mode (Cool/Heat) will be defined according to the priority unit request. If no unit is selected (as the default value) the first unit turned on determines the unit mode.

1. Scroll down the **Down** button until setup is displayed (Stp) and then press the **Select** button.

2. Scroll down the **Down** button to choose the unit priority requested and then press the **Select** button:

Display Board Menu list

Mode (Cl/Ht/Sb)

- Technician Test (tt)
 - Technician Test Cool (ttC)
 - Technician Test Heat (ttH)
- Installation Test (it)
- Diagnostics (dia)
 - Outdoor Unit (oxx)
 - Indoor Unit A (axx)
 - Indoor Unit B (bxx)
 - Indoor Unit C (cxx)
 - Indoor Unit D (dxx)

Set Up (Stp)

- First IDU Wins (idu)
- IDU A is master (a-p)
- IDU B is master (b-p)
- IDU C is master (c-p)
- IDU D is master (d-p)
- 'Forced mode' input (Frc)

a. No unit priority - Display shows "idu" (default value).



b. Unit A is in priority - Display shows "A-p" .



c. Unit B is in priority - Display shows "b-p" .



d. Unit C is in priority - Display shows "c-p" .



e. Unit D is in priority - Display shows "d-p" .



f. Forced mode is implied.



5.2.2. Forced mode operation

If an IDU is defined as a priority unit, the operational mode (Cool/Heat) will be defined according to the priority unit request. If no unit is selected (as the default value) the first unit turned on determines the unit mode.

Setup the Forced Mode dry contact to the required mode as per the following:

- Cool open
- Heat - shorted

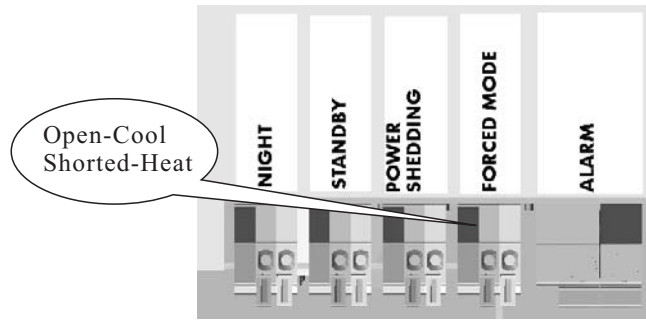

When "Forced Mode" dry contact is shorted, the unit will be forced to heat mode.

5.3. Features setup with Dry Contacts (Inputs)

The 'Input' Dry contacts are used for controlling.

An external circuitry, which may include a switch or a relay, should be used for closing the internal circuit to indicate that some change is required.

A solid wires and not stranded one is recommended to be used and up to 0.5 mm².

NO external power should be used in this case!

5.3.1. Night mode quiet operation (Cool Mode)

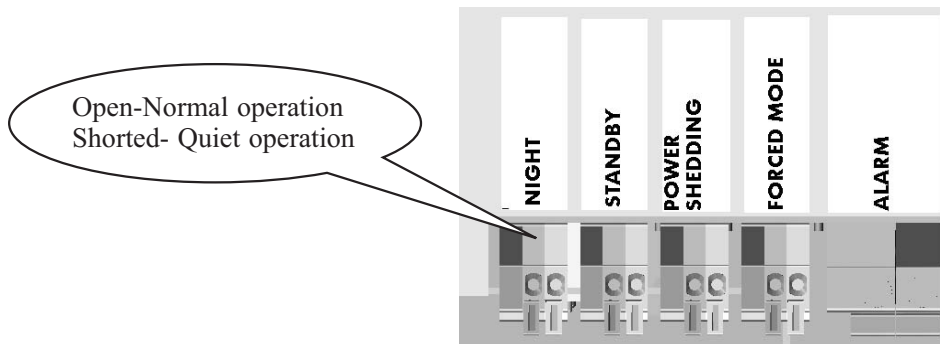

When "Night" dry contact is shorted, the unit will enter to a special night mode and reduce the compressor and outdoor fan speeds to allow quiet operation.

5.3.2. Standby

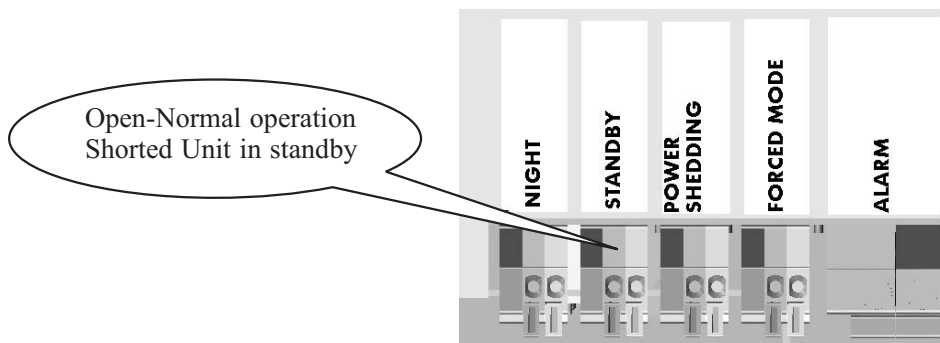

When "Standby" dry contact is shorted, the unit will stopped and stay in standby.

5.3.3. Power Shedding

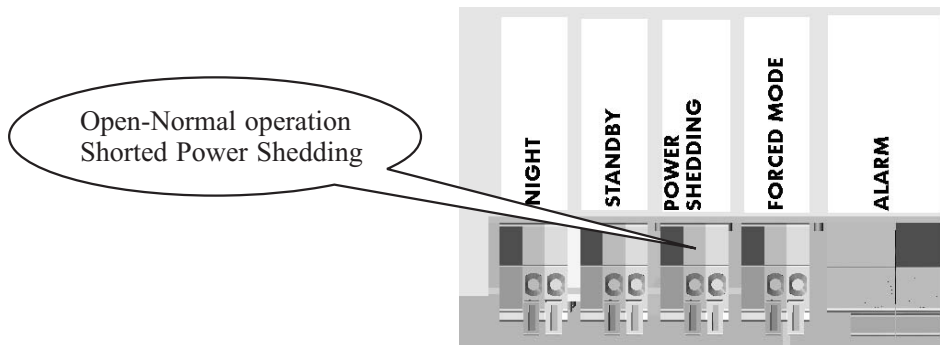

When "Power Shedding" dry contact is shorted, the unit will limit its maximum power consumption.

5.4. Features (Output)

5.4.1. Alarm

The Alarm ('Output') Dry contact is used to indicate a problem or any malfunction of the system. An internal relay is used to close an external circuit which may include an external power supply. The external circuit should include some kind of a load (lightening bulb, LED, etc.).

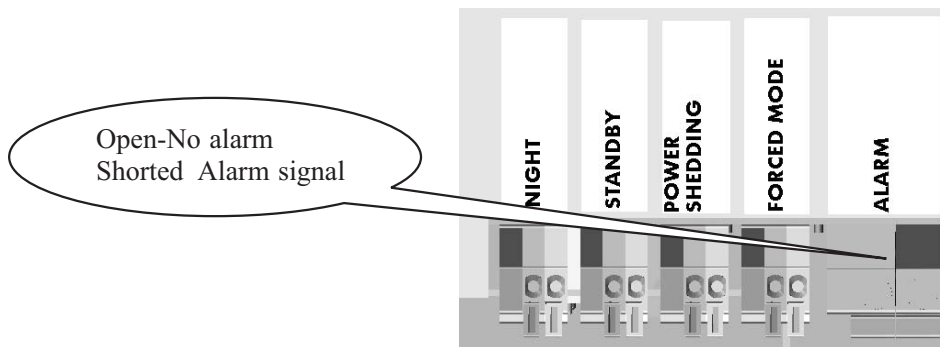

When "Alarm" dry contact is shorted, alarm output will be activated when there is any ODU Fault/Protection. Alarm output will be OFF when the Fault/Protection is cleared.

Output Specifications: Voltage-Max 240V AC
Current-Max 1.0 Amp

A solid wires and not stranded one is recommended to be used and up to 1.5mm².

INSTALLATION TEST MISWIRING CHECK

For proper system operation, each communication cable has to be connected to the corresponding indoor unit, following the refrigerant tubes. This means that the communication lines Ca, Cb, Cc, and Cd has to be connected to the indoor units A, B, C, and D respectively.

To serve this purpose the system is designed to have the "Installation Test Mode". When this mode is set, the unit verifies whether the correct connections were made or not.

Notes:

1. The miswiring check cannot be performed while outdoor temperature is below 5°C. In this situation the display will show "OAT".

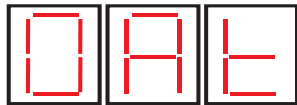

1. Outdoor Temperature below 5°C

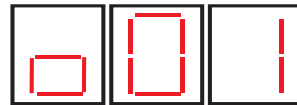

2. Unit malfunction (example: code O01)

2. The miswiring check cannot be performed if some components in the unit are out of operation. In this situation the display will show the error code "xxx".
3. The indoor units are turned automatically to installation test mode, no need to turn them on.

Please follow all the steps below:

1. Make sure all wiring and piping to indoor units are properly connected.
2. Turn on the power breaker.
3. **Enter the Test** by scrolling down to installation test (it) - press the "Down" button until "it" shows on the display and then press select for entering installation test mode.

Display Board Menu list

- Technician Test (tt)
 - Technician Test Cool (ttC)
 - Technician Test Heat (ttH)
- Installation Test (it)
- Diagnostics (dia)
 - Outdoor Unit (oxx)
 - Indoor Unit A (axx)
 - Indoor Unit B (bxx)
 - Indoor Unit C (cxx)
 - Indoor Unit D (dxx)
- Set Up (Stp)
 - First IDU Wins (idu)
 - IDU A is master (a-p)
 - IDU B is master (b-p)
 - IDU C is master (c-p)
 - IDU D is master (d-p)
 - 'Forced mode' input (Frc)

4. During installation test the system works without the installer interference. It can be observed that the compressor, outdoor fan and indoor fans are stopped and starts according to preset procedure.
5. The system exits installation test either by continuous press on the escape button for 5 seconds or when the system finishes installation test by itself after 20 to 40 minutes.
6. After installation test, the system stops for 5 minutes, and then it resumes its normal operation. The judgment code is shown on the display - either "pass" or "fail".

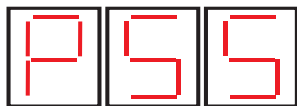

Installation test passed with success

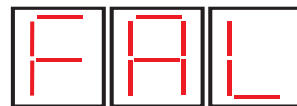

Installation test fail

7. Upon the judgment code, if required, the installer should correct the communication wiring.

FINAL TASKS

1. Check all valve caps and ensure that they had tightened properly. Close the valve cover.
2. Fill gaps on the wall between hole sides and tubing with sealer.
3. Attach wiring and tubing to the wall with clamps where necessary.
4. Operate the unit for no less than 5 minutes at heating or cooling mode.
5. Explain filter removal, cleaning and installation.
6. Operate the air conditioner together with the customer and explain all functions.
7. Give the operating and installation manuals to the customer.

