

CONCEALED AIR CONDITIONER WITH ELECTRONIC CONTROL



INSTALLATION INSTRUCTIONS

Getting Started...

REQUIRED TOOLS LIST

- | | | |
|---|------------------------------------|-------------------|
| 1. Screw driver | 8. Gas leak detector | 15. Torque wrench |
| 2. Electric drill,
hole core drill (60 mm) | 9. Measuring tape | 18 Nm (1.8 kgf.m) |
| 3. Hexagonal wrench | 10. Thermometer | 45 Nm (4.5 kgf.m) |
| 4. Spanner | 11. Megameter | 65 Nm (6.5 kgf.m) |
| 5. Pipe cutter | 12. Multimeter | 75 Nm (7.5 kgf.m) |
| 6. Reamer | 13. Vacuum pump | 85 Nm (8.5 kgf.m) |
| 7. Knife | 14. Gauge manifold
(for R-410A) | |

ATTENTION

1. Selection of the unit's location.
Select a location, which is rigid and strong enough to support or hold the unit, and select a location for easy maintenance.
2. Do not release refrigerant during piping work for installation, reinstallation and during the reparation of refrigeration parts. Take care of the liquid refrigerant, it may cause frostbite.
3. Installation work. It may need two people to carry out the installation work.
4. Do not install this appliance in a laundry room or humid ambient where water may drip from the ceiling, etc.

Operating Temperature

Range:

-9°C ~ -43°C

Contents:

Installation/Service Tooling	4	Pipes connections	15
Attached Accessories	6	Cutting and flaring	15
General information	7	Pipe insulation	15
General precautions	9	Pipe connections to the unit	16
Indoor unit	10	Evacuation of pipes and indoor unit	16
Access to the unit	10	Electrical connections	17
Unit Installation	11	Display Control Unit	FJ
Drainage installation	12	Check list before operation	2€
Air filter location	13		
Outdoor unit	14		
Unit dimensions	14		
Several outdoors installation	14		
Disposal of outdoor unit condensed water	15		

SAFETY PRECAUTIONS

Read the following "SAFETY PRECAUTIONS" carefully before installation. Electrical work must be installed by a licensed electrician. Be sure to use the correct rating of the power plug and main circuit for the model to be installed. The caution items stated here must be followed because these important contents are related to safety. The meaning of each indication used is as below.

Incorrect installation due to ignoring the instructions will cause harm or damage, and the seriousness is classified by the following indications.

Carry out test running to confirm that no abnormality occurs after the installation. Then, explain to user the operation, care and maintenance as stated in instructions. Please remind the customer to keep the operating instructions for future reference.

The items to be followed are classified by the symbols:



WARNING



This indication shows the possibility of causing death or serious injury.







Symbol with background white denotes item that is PROHIBITED from doing.

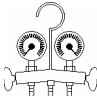
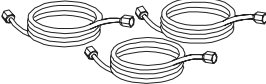

WARNING

1. Use qualified installer and follow carefully the instructions, otherwise it will cause electrical shock, water leakage, or aesthetic problem.
2. Install at a strong and firm location, which is able to withstand the set's weight. If the strength is not enough or installation is not properly done, the set will drop and cause injury.
3. For electrical work, follow the local national wiring standard, regulation and the installation instructions. An independent circuit and single outlet must be used. If electrical circuit capacity is not enough it will cause electrical shock or fire.
4. Use the specified cable and connect tightly for indoor/outdoor connection. Connect tightly and clamp the cable so that no external force will be acted on the terminal. If connection or fixing is not perfect, it will cause heat-up or fire at the connection.
5. Wire routing must be properly arranged so that control board cover is fixed properly. If control board cover is not fixed perfectly, it will cause heat-up at connection point of terminal, fire or electrical shock.
6. Before obtaining access to terminals, all supply circuits must be disconnected.
7. When carrying out piping connection, take care not to let air substances other than the specified refrigerant go into refrigeration cycle, otherwise, it will cause lower capacity, abnormal high pressure in the refrigeration cycle, explosion and injury. 
8. Do not damage or use unspecified power supply cord. Otherwise, it will cause fire or electrical shock. 
9. Do not modify the length of the power supply cord or use of the extension cord, and do not share the single outlet with other electrical appliances. Otherwise, it will cause fire or electrical shock.
10. This equipment must be earthed. It may cause electrical shock if grounding is not perfect. 
11. Do not install the unit at place where leakage of flammable gas may occur. In case of gas leaks and accumulates at surrounding of the unit, it may cause fire.
12. Carry out drainage piping as mentioned in installation instructions. If drainage is not perfect, water may enter the room and damage the furniture.
13. If supply cord is damaged, it must be replaced by the manufacturer, its service agent or similarly qualified persons in order to avoid a hazard.

Installation/Service Tooling for R410A	Changes
Gauge manifold 	As the working pressure is high, it is impossible to measure the working pressure using conventional gauges. In order to prevent any other refrigerant from being charged, the port diameters have been changed.
Charge hose 	In order to increase pressure resisting strength, hose materials and port sizes have been changed (to 1/2 UNF 20 threads per inch). When purchasing a charge hose, be sure to confirm the port size.
Electronic scale for refrigerant charging 	As working pressure is high and gasification speed is fast, it is difficult to read the indicated value by means of charging cylinder, as air bubbles occur.
Torque wrench (nominal dia. 1/2, 5/8) 	The size of opposing flare nuts has been increased. Incidentally, a common wrench is used for nominal diameters 1/4 and 3/8.
Flare tool (clutch type) 	By increasing the clamp bars receiving hole size, strength of spring in the tool has been improved.
Gauge for projection adjustment	Used when flare is made by conventional flare tool.
Vacuum pump adapter & check valve	Connected to a conventional vacuum pump. It is necessary to use an adapter to prevent vacuum pump oil from flowing back into the charge hose. The charge hose connecting part has two ports - one for conventional refrigerant (7/16 UNF 20 threads per inch) and one for R410A. If the vacuum pump oil (mineral) mixes with R410A a sludge may occur and damage the equipment.
Gas leakage detector 	Exclusive for HFC refrigerant.

Incidentally, the "refrigerant cylinder" comes with the refrigerant designation (R410A) and protector coating in the U.S's ARI specified rose color (ARI color code: PMS 507). Also, the "charge port and packing for refrigerant cylinder" requires 1/2 UNF 20 threads per inch corresponding to the charge hose's port size.

CAUTION R410A Air Conditioner Installation

THIS AIR CONDITIONER ADOPTS THE NEW HFC REFRIGERANT (R410A) WHICH DOES NOT DESTROY OZONE LAYER. R410A refrigerant is apt to be affected by impurities such as water, oxidizing membrane, and oils because the working pressure of R410A refrigerant is approx. 1.6 times of refrigerant R22. Accompanied with the adoption of the new refrigerant, the refrigeration machine oil has also been changed. Therefore, during installation work, be sure that water, dust, former refrigerant, or refrigeration machine oil do not enter into the new type refrigerant R410A air conditioner circuit. To prevent mixing of refrigerant or refrigerating machine oil, the sizes of connecting sections of charging port on main unit and installation tools are different from those used for the conventional refrigerant units. Accordingly, special tools are required for the new refrigerant (R410A) units. For connecting pipes, use new and clean piping materials with high pressure fittings made for R410A only.

Moreover, do not use the existing piping because there are some problems with pressure fittings and possible impurities in existing piping.

Changes in the product and components

In air conditioners using R410A, in order to prevent any other refrigerant from being accidentally charged, the service port diameter size of the outdoor unit control valve (3 way valve) has been changed. (1/2 UNF 20 threads per inch). In order to increase the pressure resisting strength of the refrigerant piping, flare processing diameter and opposing flare nuts sizes have been changed. (for copper pipes with nominal dimensions 1/2 and 5/8).

In case of pipes welding please make sure to use dry Nitrogen inside the pipes.











Use copper tube of special thickness for R410A:

1/4"-1/2" 0.8 mm

5/8"-3/4" 1 mm

Do not vent **R410A** into atmosphere: **R410A** is a fluorinated greenhouse gas, covered by Kyoto Protocol, with a Global Warming Potential (GWP) = **1730**

ATTACHED ACCESSORIES

Description	Amount	Name	Use
	1	Technician's installation manual	Installation instructions
	1	Instruction manual for remote control	Operating instructions for remote
	1	Instruction manual for unit display	Operating instructions
	1	Remote control including batteries	Operating the air-conditioner
	1	Remote control bracket	Hanging the remote control on the wall
	1	Central control display	Operating and main working display
	4	Tie-Wraps	Tightening the indoor and the outdoor unit's electrical cables
	4 each	Dibbles - Screws - Washers	Installing bracket for remote control and central control display
	1	Drain elbow	Connecting drain hose to outdoor
	1+1	Gas tubing insulation	Additional insulation on both gas connections

GENERAL INFORMATION

Indoor Unit The unit can be installed as concealed unit above a false ceiling or as vertical floor mounted.
Since the unit is a concealed and not a ducted unit, it is very important that the ducts length fits the maximum external static pressure allowed in the table in page I .

Horizontal Installation



Outdoor Unit

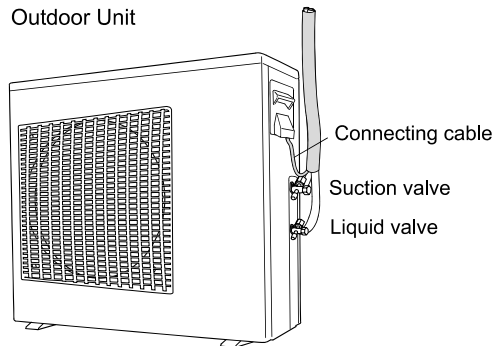

MAXIMUM PIPES LENGTH & HEIGHT				
CAPACITY	TUBES OD	LENGTH(A)	HEIGHT(B)	ADDITIONAL CHARGE
09KBTU	1/4"-3/8"	20	15	30
12KBTU	1/4"-1/2"	20	15	30
18KBTU	1/4"-1/2"	20	15	30
24KBTU	3/8"-5/8"	30	15	60
30KBTU	3/8"-5/8"	30	15	60
36KBTU	1/2"-3/4"	50	30	120
42KBTU	1/2"-3/4"	50	30	120
60KBTU	1/2"-3/4"	50	30	120

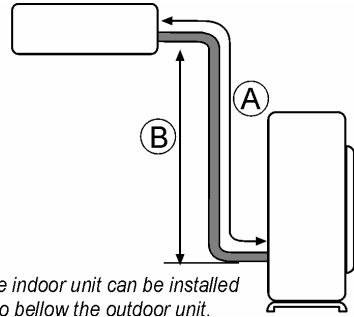

EXTERNAL STATIC PRESSURE		
NOMINAL CAPACITY	NOMINAL	MAX
9K~18K	25	25
24K	25	80
30K	35	50
36~42K	37	150
60K	50	150

GENERAL PRECAUTIONS

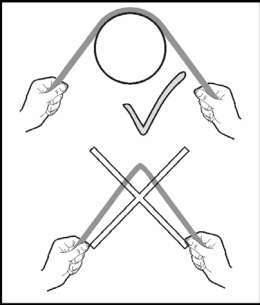

Always use the support of a large radius cylinder for banding the tubes, using pipe bending tools

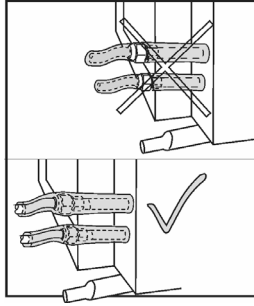

Do not leave nuts of gas tubes uncovered. Isolate the connections with the supplied tube insulation

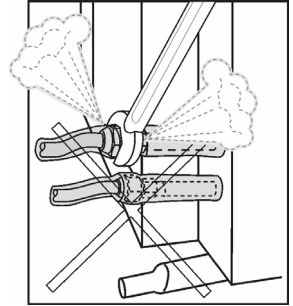

Do not unscrew gas tubes after installation

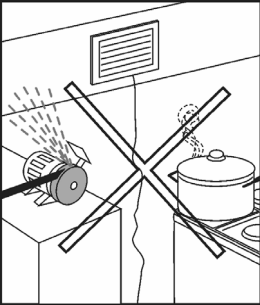

Avoid placing the indoor unit near water or oily mist

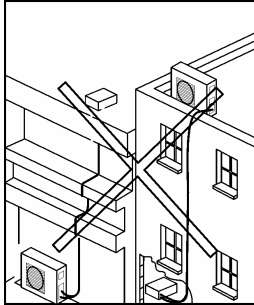

Avoid pipes bending and keep them as short as possible, minimum 3 meters

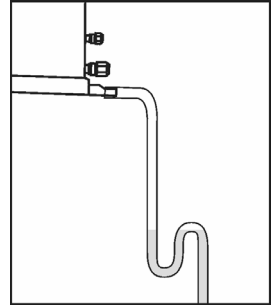

Making of a water trap (Siphon) will prevent bad odors

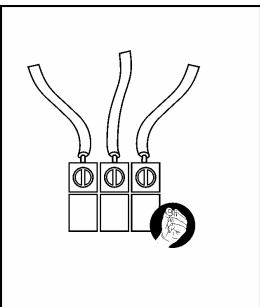

Tighten electrical Circuit's cables

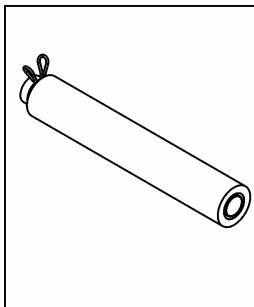

Insulate drainage tube

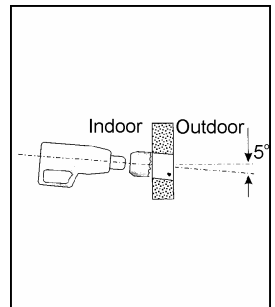

Drill the hole at an angle to prevent condensate or rain water from penetrating back into the room

INDOOR UNIT

UNIT LOCATION

- While selecting a place for the indoor unit:
- Allow max. air flow to the desired space.
 - Allow max return air flow.
 - Ensure adequate drainage of condensate water.
 - Ensure noise reduction near bedrooms.
 - Leave a minimum 200 mm free space in the rear side of the unit.
 - Allow a free service access to electrical box.
 - Allow easy access to the base of the indoor unit while providing enough space from the ceiling.
 - Use serrated rubber under the unit and flexible joints to avoid resonance vibrations.

UNIT DIMENSIONS

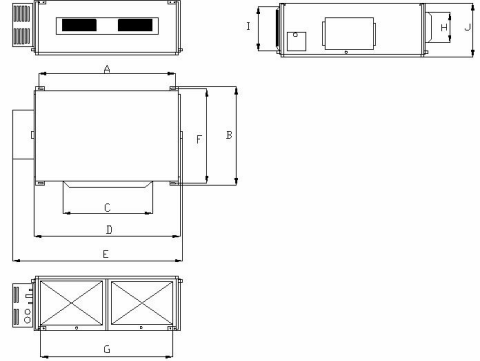

Unit: mm

Model	A	B	C	D	E	F	G	H	I	J
009	856	571	515	790	913	680	750	100	172	220
012										
018	932	627	738	894	1012	736	738	125	207	266
024										
030	1101	395	820	1159	1270	504	1002	160	235	268
036										
042	1011	635	820	1115	1251	744	980	160	231	290
060	1015	679	820	1115	1251	788	980	160	261	330

CLEARANCE AROUND THE UNIT AND SERVICE ACCESS

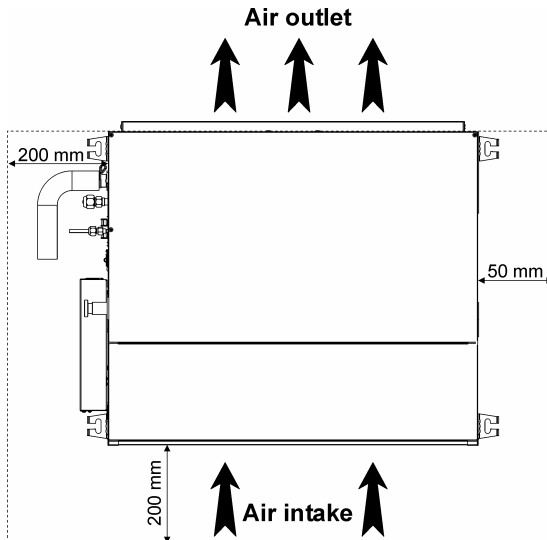

UNIT INSTALLATION

- a. Insert 4 M10 or 3/8" threads rods into the ceiling.
- b. Introduce the rods through the slots of unit suspension brackets.
- c. Position the shock absorbers, add washers and screw the nuts until the unit is firmly supported.
- d. In case of a gap between the unit and the ceiling, put a rubber or a neoprene sheet.

IMPORTANT The unit must be perfectly leveled

DRAINAGE INSTALLATION

General

For an efficient functioning of the drainage system, please take care of the following:

- Always balance the unit with 2° downward to the drainage side of the unit.
- Use 19 mm tube drainage.
- It is recommended to prepare a drainage point by professional plumber close to the unit.
- For proper drainage, the passage must be planned with 1° down slope.
- Prevent any upwards or reverse flow in any part.
- For preventing unpleasant smells in the room, install a siphon in the installation.
- Install the draining tube with 6 mm thickness thermal insulation sleeve.

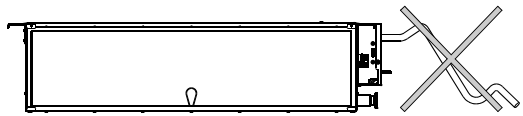
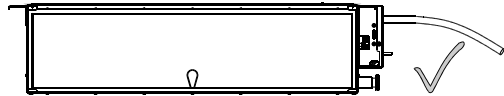
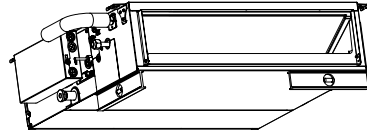

Horizontal drainage

- The unit includes a drain pump, which can elevate condensate water up to 120 cm from the unit lowest level. The drainage tube is connected to the upper drainage nozzle.
- The lower drainage nozzle role is to empty the drain pan before servicing the unit.
- Install on the drain tube with 5-10 mm thickness thermal insulation sleeve to prevent drippings.

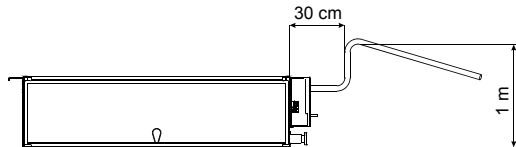

AIR FILTER LOCATION

The air filter is located in the rear side of the unit (default from factory) but can be easily relocated in the bottom of the unit if it is required. For vertical installation, it is recommended to relocate the filter in front of the unit.

AIR FILTER CLEANING

For cleaning the filter remove it by pushing up toward the back of the unit and pull it out as described below.

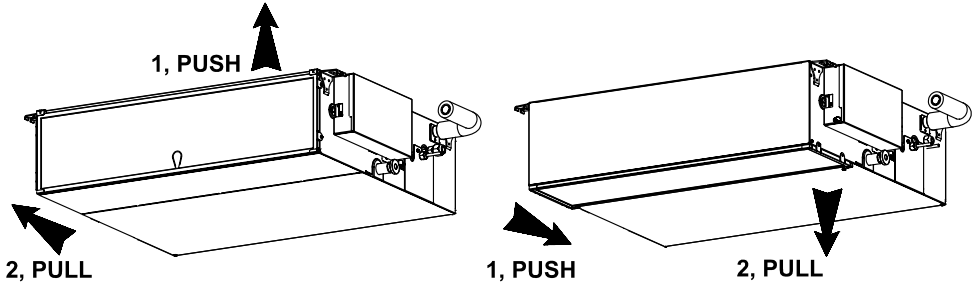

AIR FILTER RELOCATION

1. Remove air filter from the unit.
2. Remove panel 4.
3. Remove filter trails 2-3.
4. Insert filter trails 2-3 on the opposite side of the unit.
5. Close panel 4 in the rear side of the unit.
6. Insert the filter into the trails.

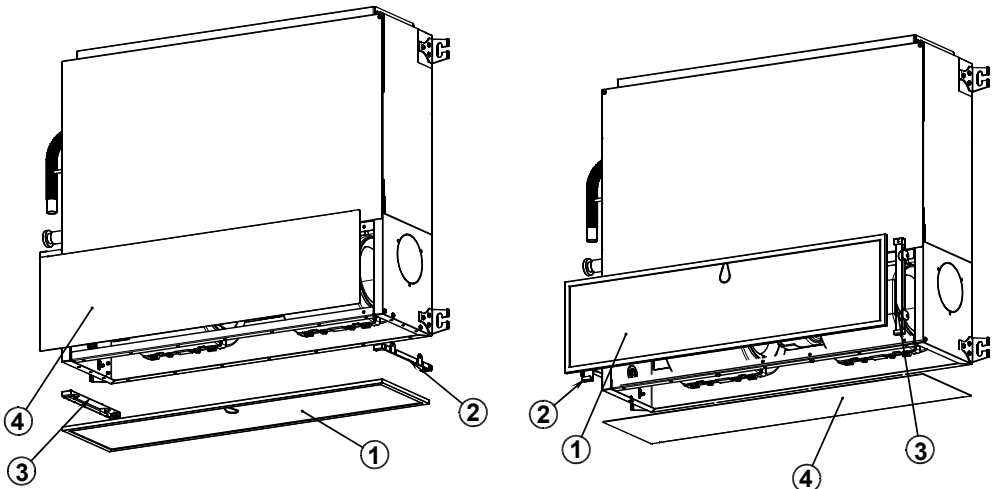

OUTDOOR UNIT

UNIT DIMENSIONS

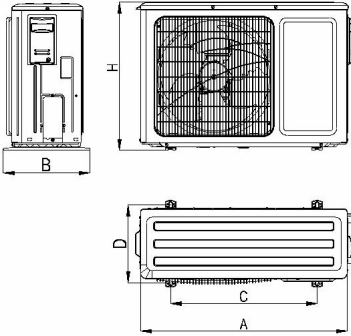

Model	A	B	C	H	D
009					
012	848	320	540	540	286
018					
024	1018	412	572	700	300
030	980	427		790	
036					
036T	1018	412	572	840	378
042T					
060T	950	412	572	1250	378

CLEARANCES AROUND THE UNIT

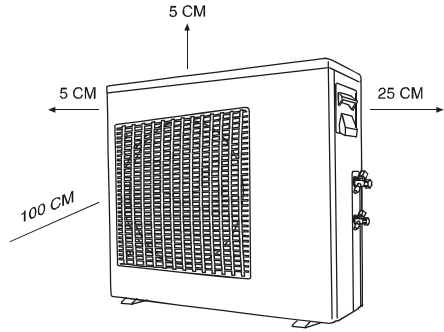

SEVERAL OUTDOORS INSTALATION

When installing several outdoor units please take into account the air flow around the units and follow the minimum distance suggestions as shown in the diagrams below.

Row Installation

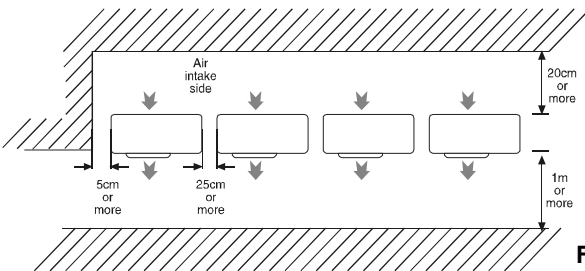

Back to Back Front to Front

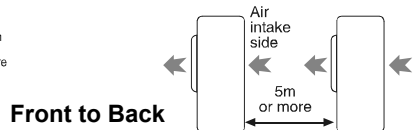
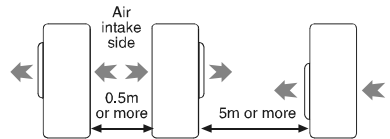

DISPOSAL OF OUTDOOR UNIT CONDENSED WATER

In case of using a drain elbow, the unit should be placed on a stand at least 3 cm high.

Install the hose with a downward to allow smooth flow of draining water.

Use 16mm I.D. tube for drainage.

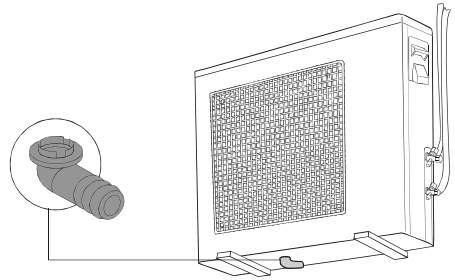

PIPES CONNECTIONS

CUTTING AND FLARING THE PIPES

1. Please use the pipe cutter for cutting the pipes.

2. Remove all burrs by using reamer. Gas leakage might happen if burrs are not removed!

Turn pipes edge down to avoid metal powder from entering down the pipes.

3. After inserting the flare nut into the copper pipes, please make a flare.

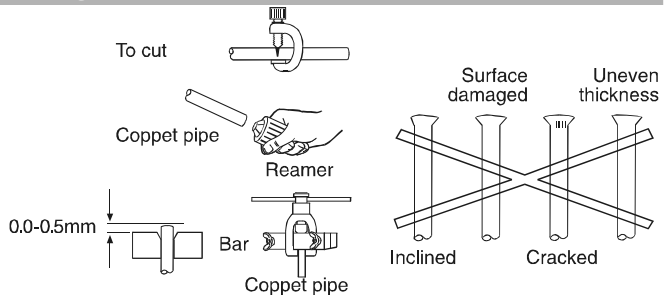

PIPE INSULATION

1. Please carry out insulation at pipe connection portion as mentioned in Indoor/ Outdoor Unit Installation Diagram. Please wrap the insulated piping end to prevent water from going inside the piping.

2. If drain hose or connecting pipes is in the room (where dew may form). Please increase the insulation by using POLY-E FOAM with thickness of 9 mm or more.

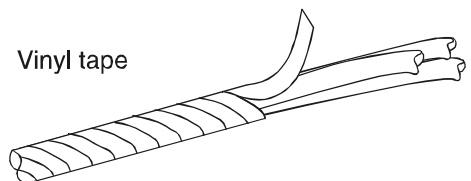

PIPE CONECTIONS TO THE UNIT

Connection to the indoor unit

1. Align the center of the pipes and finger tight the flare nut.
2. Use the torque wrench to tighten the nut firmly.

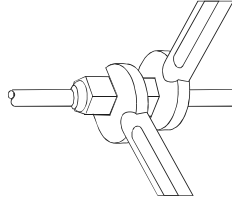

Connection to the outdoor unit

1. Align the center of the pipes to the valves.
2. Use the torque wrench to tighten the valves firmly according to table:

Tube (Inch)/ Torque(N.m)	1/4	3/8	1/2	5/8	3/4
Flare Nuts	13-18	40-45	60-65	70-75	80-85
Valve Cap	13-20	13-20	18-25	18-25	40-50
Service Port Cap	11-13	11-13	11-13	11-13	11-13

VACUUM OF PIPES AND INDOOR UNIT

After connection the unions of the indoor and outdoor units, evacuate the air from the tubes and from the indoor unit as follows:

1. Connect the charging hoses with a push pin to the low and high sides of the charging set and the service port of the suction and liquid valves. Be sure to connect the end of the charging hose with the push pin to the service port.
2. Connect the center hose of the charging set to a vacuum pump.
3. Turn on the power switch of the vacuum pump and make sure that the needle in the gauge moves from 0MPa (0cm Hg) to - 0.1 Mpa (-76cm Hg). Let the pump run for fifteen minutes.
4. Close the valves of both the low and high sides of the charging set and turn off the vacuum pump. Note that the needle in the gauge should not move after approximately five minutes.
5. Disconnect the charging hose from the vacuum pump and from the service ports of the suction and liquid valves.
6. Tighten the service port caps from both valves, and open them using a hexagonal Allen wrench.
7. Remove the valve caps from both valves, and open them using a hexagonal Allen wrench.
8. Remount valve caps onto both of the valves.
9. Check for gas leaks from the four unions and from the valve caps.

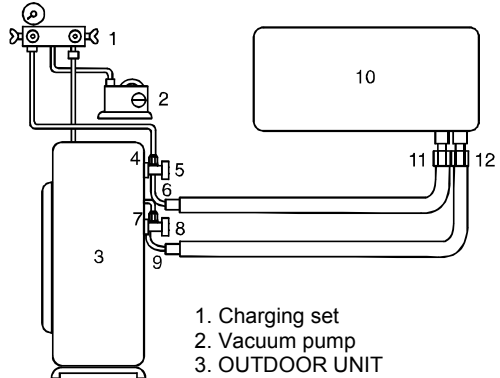

1. Charging set
2. Vacuum pump
3. OUTDOOR UNIT
4. Service valve
5. Cap
6. Suction valve
7. Service valve*
8. Cap
9. Liquid valve
10. INDOOR UNIT
11. Suction flare connection
12. Liquid flare connection

Sample

CAPACITY AND ADDITIONAL CHARGE FOR VARIOUS APPLICATIONS					
INDOOR	W/O 30	OXD 30	EXP. SL. TC	ENG 30	
	~300	350	R/L 30	UL 30	
	NO. IC	TR 50	CX 30	PL 30	
COOLING CAPACITY	2000W	2500W	3000W	3500W	4000W
HEATING CAPACITY	2000W	2500W	3000W	3500W	4000W
REF. No.	4000	4500	5000	5500	6000
REF. No.	4000	4500	5000	5500	6000

REF. No. 4000 4500 5000 5500 6000

REF. No. 4000 4500 5000 5500 6000

NOTE: For additional charge of various tubing lengths, refer to outdoor unit table.

ELECTRICAL CONNECTIONS

POWER SUPPLY

Electrical wiring and connections should be made by qualified electricians in accordance with local electrical codes and regulation. The air conditioner units must be grounded. The air conditioner units must be connected to an adequate power outlet from a separate branch circuit protected by a time delay circuit breaker, as specified on unit's nameplate. Voltage should not vary beyond $\pm 10\%$ of the rated voltage.

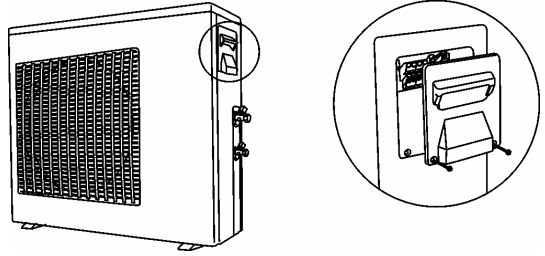

1. Prepare the multiple wire cable ends for connection.
2. Take away the Indoor/outdoor cover and open the terminals, take away the cable clamp screw and turn over the cable clamp.
3. Connect the cable ends to the terminals of the indoor and outdoor units.
4. Connect the other end of the twin wire cable to the outdoor unit twin wire terminal.
5. Secure the multiple wire power cable with the cable clamps.

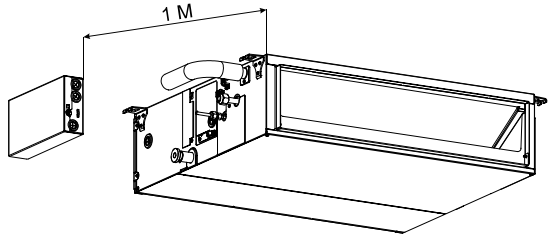

1PH 230V

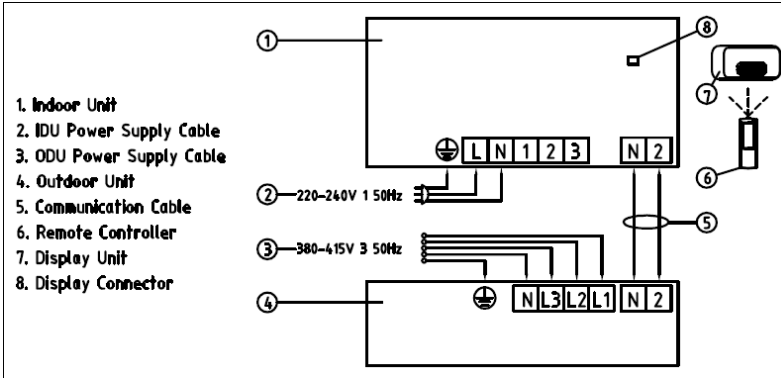

3PH 380V

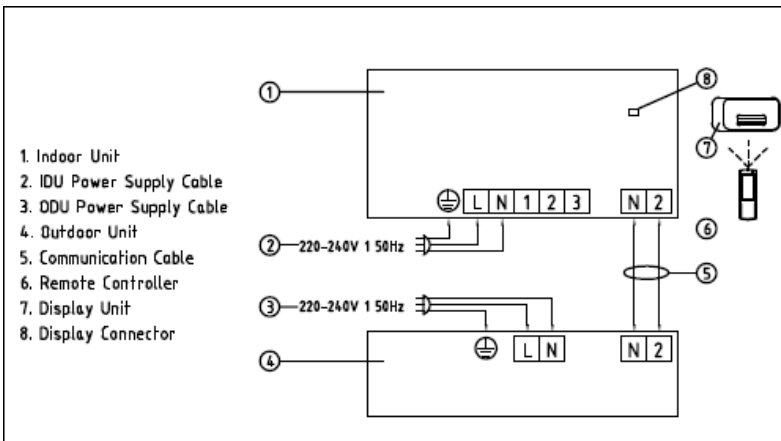

Desc.	1 PH 230V		3 PH 380V
	9000Btu/h~24000Btu/h	30000Btu/h~36000Btu/h	
Power Cable(ODU)	3 x 2.5 mm ²	3 x 6.0 mm ²	5 x 4.0 mm ²
Power Cable(IDU)	3 x 1.5 mm ²		
Communicate	2 x 0.75 mm ²		

DISPLAY CONTROL UNIT

LOCATION CRITERIA

It is recommended to install the Display Control Unit close to a ceiling in a central and neutral zone at typical conditions. In addition, the aesthetic aspect should be considered. The Display Control Unit is connected to the main control board on the air conditioner (the indoor unit) by a communication cable. The cable is connected to the Display Control Unit by a quick-connector. (8 pin plug)

INSTALLATION OF DISPLAY CONTROL UNIT ON WALL

Drill a 12 mm diameter hole on the wall, for routing the communication cable.

Open the unit cover, drill 3 holes in the wall to match the holes in the Display Control Unit, install the inserts and fasten the unit to the wall with 3 screws.

The Display Control Unit is provided of a special communication cable, 7 meters long, terminated by a plug, connected in the housing itself to a distribution box, which enables the control of the air conditioner from several different rooms, each one from its own Display Control Unit.

Connect the quick connector to the appropriate socket on the main control board in the indoor unit electrical box.



WARNING

The plug should not be cut off from the communication cable if the cable length is insufficient. In such case, a 5-meter extension cable may be added.

CONSIDERATIONS IN LOCATING THE REMOTE CONTROL UNIT

- a) Locate the Remote Controller Unit in such way that when mounted on its support on the wall, it will be in line sight with the Display Control Unit (at less than 8 m).
- b) It is recommended to establish the final location of the Remote Control Unit only after the first operation, assuring proper transmission and reception between the Remote Controller Unit and the Display Control Unit.

Check list before operation

CHECK THE DRAINAGE

Pour water into the drain tray-styrofoam. Ensure that water flows out from drain hose of the indoor unit.

EVALUATION OF THE PERFORMANCE

Operate the unit at cooling mode and high fan speed for fifteen minutes or more. Measure the temperature of the intake and discharge air. Ensure the difference between the intake temperature and the discharge is more than 8 °C

CHECK ITEMS

- | | |
|--|---|
| <input type="checkbox"/> Is there any gas leakage at flare nut connections? | <input type="checkbox"/> Is the indoor unit properly mounted to the ceiling? |
| <input type="checkbox"/> Has the heat insulation been carried out at flare nut connection? | <input type="checkbox"/> Is the power supply voltage complied with rated value? |
| <input type="checkbox"/> Is the connecting cable being fixed to terminal board firmly? | <input type="checkbox"/> Is there any abnormal sound? |
| <input type="checkbox"/> Is the connecting cable being clamped firmly? | <input type="checkbox"/> Is the cooling operation normal? |
| <input type="checkbox"/> Is the drainage OK?
(Refer to "Check the drainage" section) | <input type="checkbox"/> Is the thermostat operation normal? |
| <input type="checkbox"/> Is the earth wire connection properly done? | <input type="checkbox"/> Is the remote control's LCD operation normal? |