

INSTALLATION MANUAL MANUEL D'INSTALLATION INSTALLATIONSHANDBUCH MANUALE DI INSTALLAZIONE MANUAL DE INSTALACIÓN ИНСТРУКЦИЯ ПО УСТАНОВКЕ

For correct installation, read this manual before starting installation .
This manual may be subject to change without notice for purpose of improvement

Afin d'effectuer une installation correcte, lire le manuel avant de commencer l'installation. Des changements peuvent être effectués dans ce manuel sans préavis, afin d'améliorer la qualité de l'appareil

Um eine korrekte Installation vorzunehmen, sollte dieses Handbuch vor Installationsbeginn gelesen werden. Dieses Handbuch kann ohne Vorankündigung aus Verbesserungsgründen geändert werden.

Per un'installazione corretta, leggere il presente manuale prima di effettuare l'installazione.
Il presente manuale può essere soggetto a modifica senza alcun tipo di preavviso al fine di apportare dei miglioramenti.

Para una correcta instalación, lea este manual antes de iniciar la instalación.
Este manual puede estar sujeto a cambios de mejora sin previo aviso.

Прежде чем пользоваться кондиционером, прочтите пожалуйста эти инструкции; сохраняйте эту инструкцию для справок которые могут понадобиться в будущем.

CONTENTS

1. PRECAUTIONS	1
2. INSTALLATION INFORMATION	2
3. INSTALLATION/SERVICE TOOLS (only for R410A product)	3
3. ATTACHED FITTINGS	4
4. INSTALLATION PLACE	5
5. INDOOR UNIT INSTALLATION	6
6. OUTDOOR UNIT INSTALLATION	9
7. INSTALL THE CONNECTING PIPE	10
8. CONNECT THE DRAIN PIPE	14
9. WIRING	16
10. TEST OPERATION	19

PRECAUTION

SAFETY CONSIDERATIONS

Installation and servicing of air conditioning equipment can be hazardous due to system pressure and electric components. Only trained and qualified service personnel should install, repair or service air conditioning equipment.

All other operations should be performed by trained service personnel. When working on air conditioning equipment, observe precautions in the literature, tags and labels attached to the unit and other safety precautions that may apply. Follow all safety codes. Wear glasses and work gloves. Use quenching cloth for brazing and unbrazing operations. These are fire extinguishers available for all brazing operations.

WARNING

This manual describes the installation of specified indoor units. Do not install them connected with any other indoor and outdoor unit. Mismatching of units and incompatibility between control devices in the two units could lead to damage of both units.

WARNING

Before performing service or maintenance operations on system, turn off main power switch of the unit. Electrical shock could cause personal injury.

This unit shall be installed in accordance with national wiring regulations.

WARNING

If the supply cord is damaged, it must be replaced by the manufacture or its service agent or similarly qualified person in order to avoid a hazard.

The means for disconnection from the supply having a contact separation of at least 3 mm in all poles.

CAUTION

1. Wire the outdoor unit, then wire the indoor unit. You are not allowed to connect the air conditioner with the power source unit wiring and piping the air conditioner is done.
2. For installation of the indoor unit, outdoor unit, and connection piping in between, follow the instructions given in this manual as strictly as possible.
3. Installation in the following places may cause trouble. If it is unavoidable, please consult with the dealer.
 - (1) A place full of machine oil.
 - (2) A saline place such as coast.
 - (3) Hot-spring resort.
 - (4) A place full of sulfide gas.
 - (5) A place where there are high frequency machines such as wireless installation, welding machine, medical facilities.
 - (6) A place of special environmental conditions.

NOTE

Remark per EMC Directive 89/336/EEC

To prevent flicker impressions during the start of the compressor (technical process), following installation conditions do apply.

1. The power connection for the air conditioner has to be done at the main power distribution. The distribution has to be of a low impedance, normally the required impedance reaches at a 32 A fusing point.
2. No other equipment has to be connected with this power line.
3. For detailed installation acceptance please refer to your contract with the power supplier, if restrictions to apply for products like washing machines, air conditioners or electrical oven.
4. For power details of the air conditioner refer to the rating plate of the product.
5. For any question contact your local dealer.

INSTALLATION INFORMATION

- & To install properly, please read this "installation manual" at first.
- & The air conditioner must be installed by qualified persons.
- & When installing the indoor unit or its tubing, please follow this manual as strictly as possible.
- & When all the installation work is finished, please turn on the power only after a thorough check.

CAUTIONS FOR THE REMOTE CONTROLLER OPERATION

- & Please do not throw the remote controller or beat it.
- & Please use the remote controller within the allowed distance, and keep the transmitter toward the receiver of the indoor unit.
- & Please keep the remote controller more than 1 m away from TV or stereo set.
- & Never put the remote controller at the place with humid or direct sunlight, or near heaters.

INSTALLATION ORDER

1. Select the location
2. Install the indoor unit
3. Install the outdoor unit
4. Install the connecting pipe
5. Connect the drain pipe
6. Wiring
7. Test operation

INSTALLATION/SERVICE TOOLS (ONLY FOR R410A PRODUCT)

CAUTION

New Refrigerant Air Conditioner Installation

THIS AIR CONDITIONER ADOPTS THE NEW HFC REFRIGERANT (R410A) WHICH DOES NOT DESTROY OZONE LAYER. R410A refrigerant is apt to be affected by impurities such as water, oxidizing membrane, and oils because the working pressure of R410A refrigerant is approx. 1.6 times of refrigerant R22. Accompanied with the adoption of the new refrigerant, the refrigeration machine oil has also been changed. Therefore, during installation work, be sure that water, dust, former refrigerant, or refrigeration machine oil does not enter into the new type refrigerant R410A air conditioner circuit.







To prevent mixing of refrigerant or refrigerating machine oil, the sizes of connecting sections of charging port on main unit and installation tools are different from those used for the conventional refrigerant units. Accordingly, special tools are required for the new refrigerant (R410A) units. For connecting pipes, use new and clean piping materials with high pressure fittings made for R410A only, so that water and/or dust does not enter. Moreover, do not use the existing piping because there are some problems with pressure fittings and possible impurities in existing piping.

Changes in the product and components

In air conditioners using R410A, in order to prevent any other refrigerant from being accidentally charged, the service port diameter size of the outdoor unit control valve (3 way valve) has been changed. (1/2 UNF 20 threads per inch)

- In order to increase the pressure resisting strength of the refrigerant piping, flare processing diameter and opposing flare nuts sizes have been changed. (for copper pipes with nominal dimensions 1/2 and 5/8)













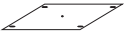

New tools for R410A

New tools for R410A	Applicable to R22 model	Changes
Gauge manifold	×	 As the working pressure is high, it is impossible to measure the working pressure using conventional gauges. In order to prevent any other refrigerant from being charged, the port diameters have been changed.
Charge hose	×	 In order to increase pressure resisting strength, hose materials and port sizes have been changed (to 1/2 UNF 20 threads per inch). When purchasing a charge hose, be sure to confirm the port size.
Electronic balance for refrigerant charging	○	 As working pressure is high and gasification speed is fast, it is difficult to read the indicated value by means of charging cylinder, as air bubbles occur.
Torque wrench (nominal dia. 1/2, 5/8)	×	 The size of opposing flare nuts have been increased. Incidentally, a common wrench is used for nominal diameters 1/4 and 3/8.
Flare tool (clutch type)	○	 By increasing the clamp bar's receiving hole size, strength of spring in the tool has been improved.
Gauge for projection adjustment	—	Used when flare is made by using conventional flare tool.
Vacuum pump adapter	○	 Connected to conventional vacuum pump. It is necessary to use an adapter to prevent vacuum pump oil from flowing back into the charge hose. The charge hose connecting part has two ports – one for conventional refrigerant (7/16 UNF 20 threads per inch) and one for R410A. If the vacuum pump oil (mineral) mixes with R410A a sludge may occur and damage the equipment.
Gas leakage detector	×	 Exclusive for HFC refrigerant.

- Incidentally, the "refrigerant cylinder" comes with the refrigerant designation (R410A) and protector coating in the U.S.'s ARI specified rose color (ARI color code: PMS 507).
- Also, the "charge port and packing for refrigerant cylinder" requires 1/2 UNF 20 threads per inch corresponding to the charge hose's port size.

ATTACHED FITTINGS

Please check whether the following fittings are of full scope. If there are some attached fittings free from use, please restore them carefully.

Installation fittings	Drainpipe Fittings
1. Expansible hook 4 	5. Out-let pipe sheath 1 
2. Installation hook 4 	6. Out-let pipe clasp 1 
3. Installation paper board 1 	7. Tightening band 20 
4. Bolt M6X12 4 	8. Drain elbow 1 
	9. Seal ring 1 
Protect Pipe Fittings	Remote controller & Its Frame
10. Wall conduit 1 	12. Remote controller 1 
11. Wall conduit cover 1 	13. Frame 1
1 1	14. Mounting screw (ST2.9 X 10-C-H) 2 
1 1	15. Alkaline by batteries (AM4) 2 
Others	
16. Owner's manual 1 17. Installation manual 1 18. Rc operating manual 1 19. Rc installation manual 1 20. One-way valve throttle 1 set (only KN30/36/45 R22, R407C) 	

INSTALLATION PLACE

CAUTION

Location in the following places may cause malfunction of the machine. (If unavoidable, please consult your local dealer)

- a. There is petrolatum existing.
- b. There is salty air surrounding (near the coast).
- c. There is caustic gas (the sulfide, for example) existing in the air (near a hot spring).
- d. The Volt vibrates violently (in the factories).
- e. In buses or cabinets.
- f. In kitchen where it is full of oil gas.
- g. There is strong electromagnetic wave existing.
- h. There are inflammable materials or gas.
- i. There is acid or alkaline liquid evaporating.
- j. Other special conditions.

NOTICES BEFORE INSTALLATION

1. Select the correct carry-in path.
2. Move this unit as originally packaged as possible.
3. If the air conditioner is installed on a metal part of the building, it must be electrically insulated according to the relevant standards to electrical appliances.

1. The indoor unit

- There is enough room for installation and maintenance.
- The ceiling is horizontal, and its structure can endure the weight of the indoor unit.
- The air outlet and the air inlet are not impeded, and the influence of external air is the least.
- The air flow can reach throughout the room.
- The connecting pipe and drainpipe could be extracted out easily.
- There is no direct radiation from heaters.

2. The outdoor unit

- There is enough room for installation and maintenance.
- The air outlet and the air inlet are not impeded, and can not be reached by strong wind.
- It must be a dry and well ventilating place.
- The support is flat and horizontal and can stand the weight of the outdoor unit. And will no additional noise or vibration.
- Your neighborhood will not feel uncomfortable with the noise or expelled air.
- There is no leakage of combustible air.
- It is easy to install the connecting pipe or cables.
- Determine the air outlet direction where the discharged air is not blocked.
- A place free of a leakage of combustible gases.
- In the case that the installation place is exposed to a strong wind such as seaside or high position, secure the normal fan operation by putting the unit lengthwise along the wall or using a duct or shield plates.
- If possible, do not install the unit where it is exposed to direct sunlight.
If necessary, install a blind that does not interfere with the air flow.
- During the heating mode, the water drained off the outdoor unit. the condensate should be well drained away by the drain hole to an appropriate place, so as not to interfere other people or public.
- Select the position where it will not be subject to snow drifts, accumulation of leaves or other seasonal debris. It is important that air flow for the outdoor unit is not impeded as this will result in reduction in heating or cooling performance.

INDOOR UNIT INSTALLATION

1. Install the main body

A. The existing ceiling (to be horizontal)

- Please cut a quadrangular hole of 880X880mm in the ceiling according to the shape of the installation paper board. (Refer to Chart 3, 4)
 - The center to the hole should be at the same position of that of the air conditioner body.
 - Determine the lengths and outlets of the connecting pipe, drainpipe and cables.
 - To balance the ceiling and to avoid vibration, please enforce the ceiling when necessary.
- Please select the position of installation hooks according to the hook holes in the installation board.
 - Drill four holes of M12mm, 45-50mm deep at the selected positions on the ceiling. Then embed the expandable hooks (fittings).
 - Face the concave side of the installation hooks towards the expandable hooks. Determine the length of the installation hooks from the height of ceiling, then cut off the unnecessary part.

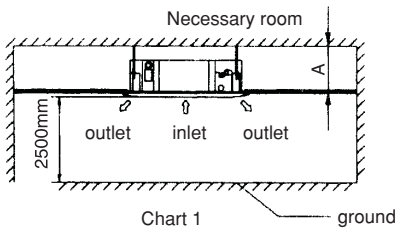
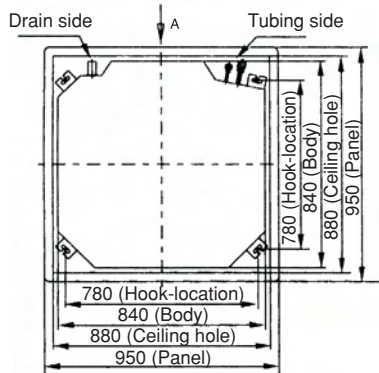

Chart 1

Note: 24/27/30 Series A 260mm
36/45 Series A 330mm



(Unit: mm)

Chart 3

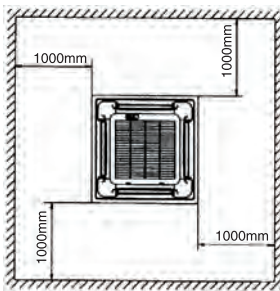
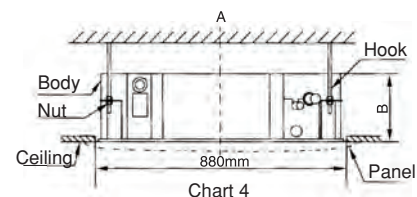

Chart 2

The length could be calculated from Chart 5:

Length= H-181+L (in general, L=100mm and is half of the whole length of the installation hook)

- Please adjust the hexangular nuts on the four installation hooks evenly, to ensure the balance of the body.
 - If the drainpipe is away, leakage will be caused by the malfunction of the water-level switch.
 - Adjust the position to ensure the gaps between the body and the four sides of ceiling are even. The body's lower part should sink into the ceiling for 10-12mm (Refer to Chart 5).
 - Location the air conditioner firmly by wrenching the nuts after having adjusted the body's position well.



Note: 24/27/30 Series B 240mm
36/45 Series B 310mm

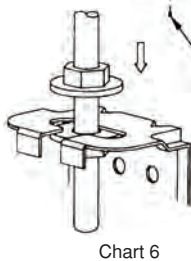
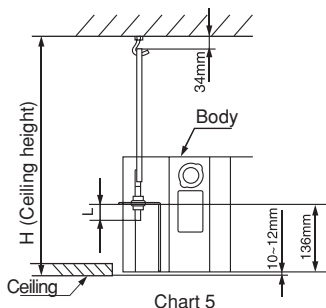
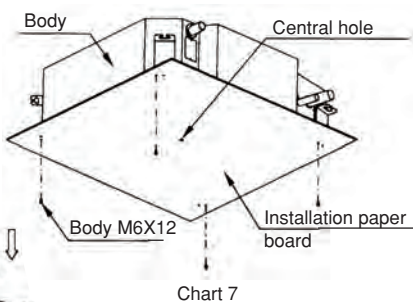

B. New built houses and ceilings

- In the case of new built house, the hook can be embedded in advance (refer to the A. B mentioned above).
But it should be strong enough to bear the indoor unit and will not become loose because of concrete shrinking.
- After installing the body, please fasten the installation paper board onto the air conditioner with bolts (M6X12) to determine in advance the sizes and positions of the hole opening on ceiling.
Please first guarantee the flatness and horizontal of ceiling when installing it.
Refer to the A. a mentioned above for others.
- Refer to the A. c mentioned above for installation.
- Remove the installation paper board.

CAUTIONS

After completion of installing the body, the four bolts (M6X12) must be fastened to the air conditioner to ensure the body is grounded well.

2. Install the panel

CAUTIONS

- Never put the panel face down on floor or against the wall, or on bulky objects.
- Never crash or strike it.

(1) Remove the inlet grid

- Slide two grid switches toward the middle at the same time, and then pull them up. (Refer to chart 8)
- Draw the grid up to an angle of about 45°, and remove it. (Refer to chart 9)

(2) Remove the installation covers at the four corners.

Wrench off the bolts, loose the rope of the installation covers, and remove them. (Refer to chart 10)



Chart 8

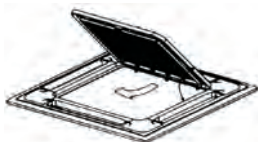

Chart 9

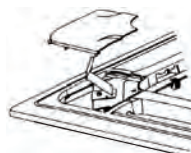

Chart 10

(3)Install the panel

- a. Align the swing motor on the panel to the tubing joints of the body properly. (Refer to chart 11)
- b. Fix hooks of the panel at swing motor and its opposite sides to the hooks of corresponding water receiver. (Refer to chart 11①) Then hang the other two panel hooks onto corresponding hangers of the body. (Refer to chart 11②)

CAUTION Do not coil the wiring of the swing motor into the seal sponge.

- c. Adjust the four panel hook screws to keep the panel horizontal, and screw them up to the ceiling evenly. (Refer to chart 11③)
- d. Regulate the panel in the direction of the arrow in Chart 11④ slightly to fit the panel's center to the center of the ceiling's opening. Guarantee that hooks of four corners are fixed well.
- e. Keep fastening the screws under the panel hooks, until the thickness of the sponge between the body and the panel's outlet has been reduced to about 4~6mm. The edge of the panel should contact with the ceiling well. (Refer to chart 12)
- Malfunction described in Chart 13 can be caused by inappropriate tightness the screw.
- If the gap between the panel and ceiling still exists after fastening the screws, the height of the indoor unit should be modified again. (Refer to chart 14-left)
- You can modify the height of the indoor unit through the openings on the panel's four corners, if the lift of the indoor unit and the drainpipe is not influenced. (Refer to chart 14-right)

(4)Hang the air-in grid to the panel, then connect the lead terminator of the swing motor and that of the control box with corresponding terminators on the body respectively.

(5)Relocate the air-in grid in the procedure of reversed order.

(6)Relocate the installation cover.

- a. Fasten the rope of installation cover on the bolt of the installation cover. (Refer to chart 15-left)
- b. Press the installation cover into the panel slightly. (Refer to chart 15-right)

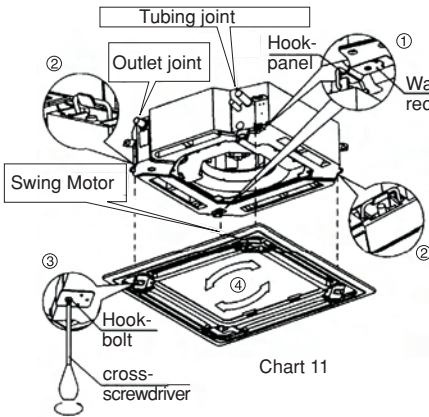

Chart 11

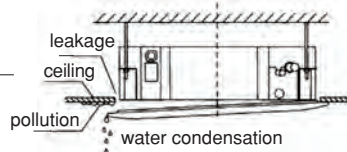

Chart 13

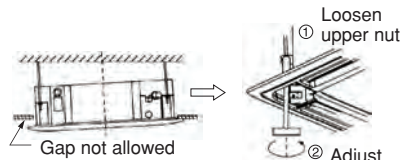

Chart 14

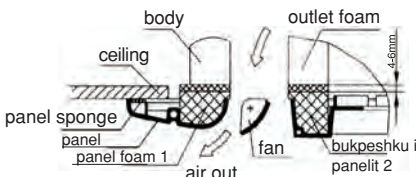

Chart 12

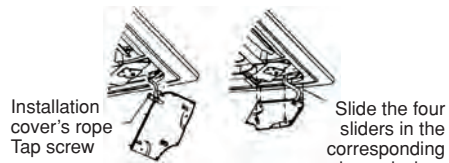

Chart 15

OUTDOOR UNIT INSTALLATION

CAUTIONS

- Keep this unit away from direct radiation of the sun or other heaters.
If unavoidable, please cover it with a shelter.
- In places near coast or with a high altitude where the wind is violent, please install the outdoor unit against the wall to ensure normal performance.
Use a baffle when necessary.
- In the case of extremely strong wind, please prevent the air from flowing backwards into the outdoor unit. (Refer to chart 16)
- Locate the outdoor unit as close to the indoor unit as possible.

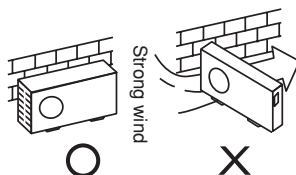

Chart 16

NECESSARY ROOM FOR installation and maintenance

(Refer to chart 17, chart 18)

If possible, please remove the obstacles nearby to prevent the performance from being impeded by too little of air circulation.

The minimum distance between the outdoor unit and obstacles described in the installation chart does not mean that the same is applicable to the situation of an airtight room. Leave open two of the three directions (A,B,C).

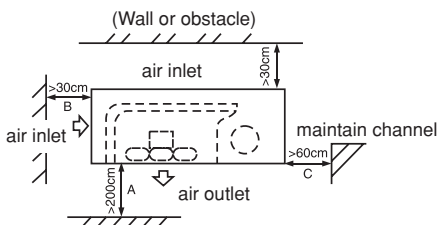

Chart 17

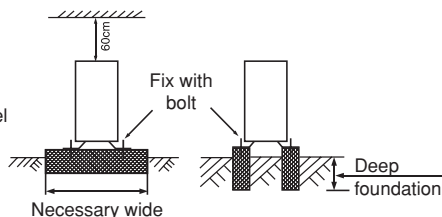

Chart 18

MOVING AND INSTALLING

- Since the gravity center of this unit is not at its physical center, so please be careful when lifting it with a sling.
- Never hold the air-in of the outdoor unit to prevent it from deforming.
- Do not touch the fan with hands or other objects.
- Do not lean it more than 45°, and do not lay it sidelong.
- Please fasten the feet of this unit with bolts firmly to prevent it from collapsing in case of earthquake or strong wind.

INSTALL THE CONNECTING PIPE

CAUTIONS

Check whether the height drop between the indoor unit and outdoor unit, the length of refrigerant pipe, and the number of the bends meet the following requirements:

The max height drop 20m.
(If the height drop is more than 10m, you had better put the outdoor unit over above the indoor unit.)
The length of refrigerant pipe less than 30m.
The number of bends less than 15

CAUTIONS

- Do not let air, dust or other impurities fall in the pipe system during the time of installation.
- The connecting pipe should not be installed until the indoor and outdoor units have been fixed already.
- Keep the connecting pipe dry, and do not let moisture in during installation .

The Procedure of Connecting Pipes

1. Measure the necessary length of the connecting pipe, and make it by the following way. (Refer to “Connect The Pipes” for details)

- 1) Connect the one-way valve restrictor in accessories to liquid tube assy, indoor unit at first (Note: only KN-30/36/45 R22, R407C)
 - 2) Connect the indoor unit, then the outdoor unit.
- Bend the tubing in proper way. Do not harm to them.

CAUTION

- Daub the surface of the flare pipe and the joint nuts with frozen oil, and wrench it for 3 ~ 4 rounds with hands before fasten the flare nuts. (Refer to chart 19)
- Be sure to use two wrenches simultaneously when you connect or disconnect the pipes.

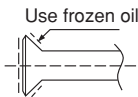

Chart 19

Bend the pipe with thumb



Min-radius 100m

Chart 20

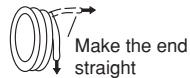

Make the end straight

Chart 21

- 3) The stop value of the outdoor unit should be closed absolutely (as original state). Every time you connect it, first loosen the nuts at the part of stop value, then connect the flare pipe immediately (in 5 minutes). If the nuts have been loosened for a long time, dusts and other impurities may enter the pipe system and may cause malfunction later.
- 4) Expel the air (refer to the “Expel The Air”) after connecting the refrigerant pipe with the indoor unit and the outdoor unit. Then fasten the nuts at the repair-points.

Notices For Bendable Pipe

- The bending angle should not exceed 90°.
- Bending position is preferably in the middle of the bendable pipe. The larger the bending radius the better it is.
- Do not bend the pipe more than three times.

Bend the connecting pipe of small wall thickness (< 9.53mm)

- Cut out a desired concave at the bending part of the insulating pipe.
- Then expose the pipe (cover it with tapes after bending).
- To prevent collapsing or deforming, please bend the pipe at its biggest radius.
- Use bender to get a small radius pipes .

Use the market brass pipe

- Be sure to use the same insulating materials when you buy the brass pipe.

2. Locate The Pipes

- Drill a hole in the wall (suitable just for the size of the wall conduit, 50,53,71 series diameter is M90mm, and 120 series diameter is M105mm in general), then set on the fittings such as the wall conduit and its cover.
- Bend the connecting pipe and the cables together tightly with binding tapes. Do not let air in, which will cause water leakage by condensation.
- Pass the bound connecting pipe through the wall conduit from outside. Be careful of the pipe allocation to do no damage to the pipe.

3. Connect the pipes

4. Then, open the stem of stop valves of the outdoor unit to make the refrigerant pipe connecting the indoor unit with the outdoor unit in fluent flow.
5. Be sure of no leakage by checking it with leak detector or soap water.
6. Cover the joint of the connecting pipe to the indoor unit with the soundproof /insulating sheath (fittings), and bind it well the tapes to prevent leakage.

Flaring

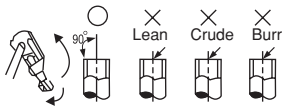

Chart 22

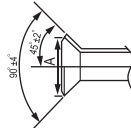

Chart 23

1. Cut a pipe with a pipe cutter.
2. Insert a flare nut into a pipe and flare the pipe.

Outside-diameter	A (mm)	
	Max	Min
1/4"	8.7	8.3
3/8"	12.4	12.0
1/2"	15.8	15.4
5/8"	19.0	18.6
3/4"	23.3	22.9

Flaring the nuts

- Put the connecting tubing at the proper position, wrench the nuts with hands, then fasten it with a wrench. (Refer to Chart 24)

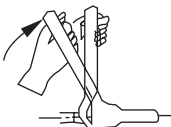

Chart 24

CAUTIONS

Too large torque will harm the bellmouthing and too small will cause leakage. Please determine the torque according to Table 2.

Tubing Size	Torque
1/4"	1420-1720 N cm (144 - 176 kgf cm)
3/8"	3270-3990 N cm (333 - 407 kgf cm)
1/2"	4950-6030 N cm (504 - 616 kgf cm)
5/8"	6180-7540 N cm (630-770 kgf cm)
3/4"	9720-11860 N cm (990-1210 kgf cm)

Table 2

Expel the air with a vacuum pump

(Refer to Chart 27)

(please refer to its manual for the way of using manifold value)

1. Loosen and remove the maintenance nuts of stop values A and B, and connect the charge hose of the manifold value with the maintenance terminator of stop value A. (Be sure that stop values A and B are both closed)
2. Connect the joint of the charge hose with the vacuum pump.
3. Open the Lo-lever of the manifold value completely.
4. Turn on the vacuum pump. At the beginning of pumping, loosen the maintenance terminator nut of stop value B a little to check whether the air comes in (the sound of the pump changes, and the indicator of compound meter turns below zero). Then fasten the nut.
5. When the pumping has finished, close the Lo-lever of the manifold value completely and turn off the vacuum pump.
 - When you have pumped for over 15 minutes, please confirm that the indicator of multi-meter is on -10×10^{-6} Pa (-76mHg).
6. Loosen and remove the quadrangle cover of stop values A and B to open stop value A and B completely, then fasten them.

7. Disassemble the charge hose from the repair-mouth of stop value A, and fasten the unit.

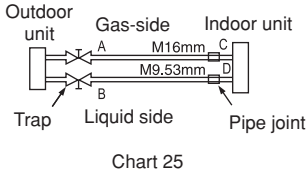

Chart 25

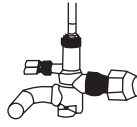

Chart 26

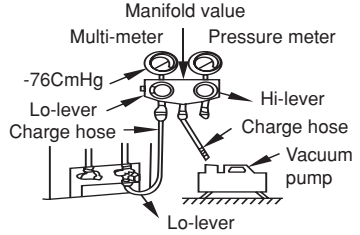

Chart 27

Operate the stop valves

- Open the valve stem until it reaches the limiter. Do not open it any further.
- Fasten the stop valves with a wrench or such tools.
- The wrench torque is listed in the Table 2 mentioned above.

CAUTIONS

All the stop valves should be opened before test operation. Each air conditioner has two stop valves of different sizes on the side of the outdoor unit, which operate as Lo-stop value and Hi-stop value; respectively. The ON/OFF operation is described in the left chart. (Refer to Chart 28)

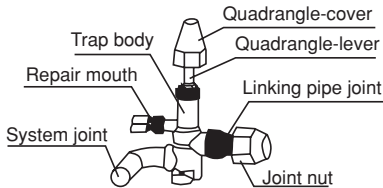

Chart 28

1) ON operation: Take off quadrangle cover, clip the quadrangle head with a wrench and turn it anticlockwise to the end. Then fasten the quadrangle cover.

2) OFF operation: The operation is the same as the ON operation, but you should turn it clockwise this time.

CHECK THE LEAKAGE

Check all the joints with the leak detector or soap water. (refer to Chart 29)

NOTE: in the chart

- A Lo-stop value
- B Hi-stop value
- C,D Joints of the connecting pipe to the indoor unit.

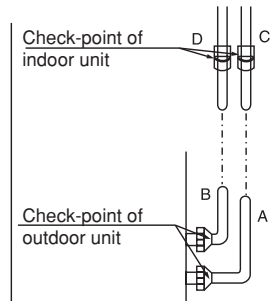

Chart 29

INSULATION

- Be sure to with insulating materials cover all the exposed parts of the flare pipe joints and refrigerant pipe on the liquid-side and the gas-side. Ensure that there is no gap between them.
- Incomplete insulation may cause water condensation.

CONNECT THE DRAIN PIPE

1. Install the drainpipe of the indoor unit .

- You can use a polyethylene tube as the drainpipe (out-dia, 37-39mm, in-dia. 32mm). It could be bought at local market or from your dealer.
- Set the mouth of the drainpipe onto the root of the body's pump-pipe, and clip the drainpipe and the out-let pipe sheath (fittings) together firmly with the out-let pipe clasp (fittings).

CAUTIONS: Use your strength carefully to prevent the pump-pipe from breaking.

- The body's pump pipe and the drainpipe (especially the indoor part) should be covered evenly with the out-let pipe sheath (fittings) and be bound tightly with the constrictor to prevent condensation caused by entered air.
- To prevent water from flowing backwards into the air conditioner while the air conditioner stops, please lean the drainpipe down toward outdoor (outlet-side) at a degree of over 1/50. And please avoid and bulge or water deposit. (Refer to chart 30. a)
- Do not drag the drainpipe violently when connecting to prevent the body from being pulled. Meanwhile, one support-point should be set every 1~1.5m to prevent the drainpipe from yielding (Refer to chart 30. b). Or you can tie the drainpipe with the connecting pipe to fix it. (Refer to chart 30. c)
- In the case of prolonged drainpipe, you had better tighten its indoor part with a protection tube to prevent it from loosening.
- If the outlet of the drainpipe is higher than the body's pump joint, the pipe should be arranged as vertically as possible. And the lift distance must be less than 200mm, otherwise the water will overflow when the air conditioner stops. (Refer to Chart 31)
- The end of the drainpipe should be over 50 mm higher than the ground or the bottom of the drainage chute, and do not immerse it in water. If you discharge the water directly into sewage, be sure to make a U-form aquaseal by bending the pipe up to prevent the smelly gas entering the house through the drain pipe.

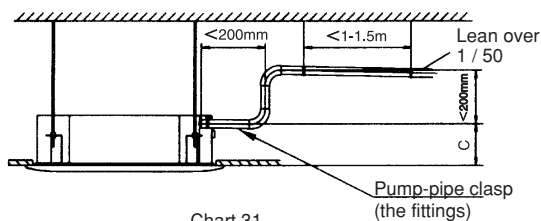
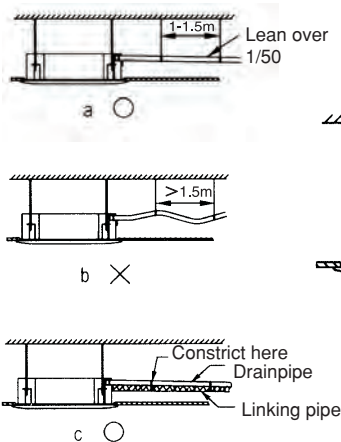

Note: 24/27/30 Series C=200mm
36/45 Series C=212mm

2. Drainage test

- Check whether the drainpipe is unhindered.
- New built house should have this test done before paving the ceiling.
 - 1) Refer to chart 32

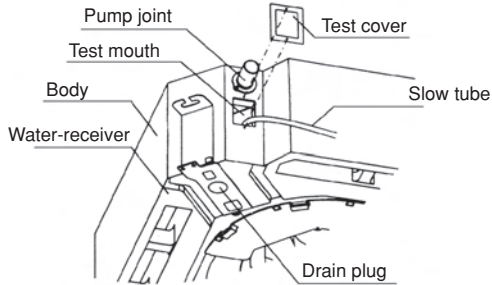

Chart 32

- 2) Turn on the power, and operate the air conditioner under the "COOLING" mode. Listen to the sound of the drain pump. Check whether the water is discharged well (a long of 1 min is allowed before discharging, according to the length of the drain pipe), and check whether water leaks from the joints.

CAUTIONS: If there is any malfunction, please resolve it immediately.

- 3) Stop the air conditioner, turn off the power, and reset the test cover to its original position.
- Imposition at all times during operation to avoid leakage.

3. Drain Elbow Installation (Cooling Only Type without)

Fit the seal into the drain elbow, then insert the drain elbow into the base pan hole of outdoor condensate draining off the outdoor unit the heating mode.

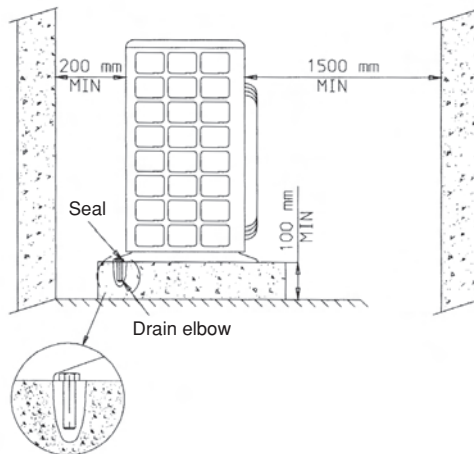

Chart 33

WIRING

CAUTION

1. The air conditioner should use separate power supply with rated voltage.
2. The external power supply to the air conditioner should have ground wiring, which is linked to the ground wiring of the indoor and outdoor unit.
3. The wiring work should be done by qualified persons according to circuit drawing.
4. A disconnection device having an air gap contact separation in all active conductors should be incorporated in the fixed wiring according to the national wiring regulation.
5. Be sure to locate the power wiring and the signal wiring well to avoid cross-disturbance and their contact with connecting pipe or stop valve body.
6. The wiring attached to this air conditioner is 6m long. Be sure to prolong it with wiring of the same type and proper length if necessary. Generally, do not twist two wiring together unless the joint is soldered well and covered with insulator tape.
7. Do not turn on the power until you checked carefully after wiring.

1. The Specification of Power

		TYPE	KN-24/27/30 SH	KN-27/30 SH3	KN-36 SH	KN-45 SH
POWER	PHASE		1-PHASE	3-PHASE	3-PHASE	3-PHASE
	FREQUENCY		50Hz	50Hz	50Hz	50Hz
	VOLT		220-240V	380V	380V	380V
CIRCUIT BREAKER/FUSE			25	20/PHASE	20/PHASE	20/PHASE
WIRING SIZE (mm ²)	POWER WIRING (INDOOR UNIT)		2.5	1.5	1.5	1.5
	GROUND WIRING		2.5	1.5	1.5	1.5
	POWER(INDOOR/OUTDOOR CONNECTING WIRING)		2.5	1.5	1.5	1.5
	STRONG ELECTRIC SIGNAL (INDOOR/OUTDOOR CONNECTING WIRING)		0.5	0.5	0.5	0.5

3. ELECTRICAL CONNECTIONS

3.1 Power supply

WARNING

Electrical connection shall be made only by authorized electricians and in accordance with local electrical requirements and codes. The system must be grounded.

Single-phase models and three phase models are available; for each of them, the necessary wiring diagram is shown. Connect the unit to the main power supply as for its applicable wiring diagram.

a) Single-phase models (See figure 35)

The main power supply cable must be HO5VV-K5G-type and contain 3X4 mm² leads.

b) Three-phase models (See Figure 36)

The main power supply cable must be HOVV-K5G- type and contain 5X2.5mm² leads.

WARNING

On unit with scroll type compressors, it is mandatory to listen to compressor operation upon initial startup. Should there be an unusual noise in operation, it is necessary to interchange the phases at the power supply connection.

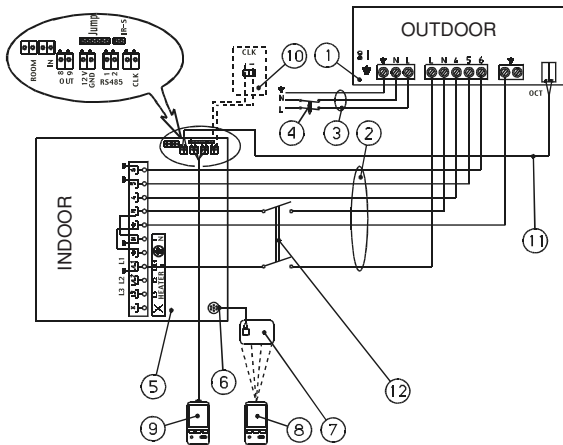

- | | |
|----------------------------|---|
| 1. Outdoor unit | 7. Display control unit |
| 2. Inter connecting cable | 8. Wireless Remote Control |
| 3. Power supply cord | 9. Wired Remote Control(optional) |
| 4. Semi-automatic switch | 10. Remote ON/OFF Switch (by Installer) |
| 5. Indoor unit | 11. Control Cable (shielded) |
| 6. Display Quick connector | 12. Switch ON/OFF (by installer) |

Figure 34: single Phase Units: electrical Scheme power to outdoor

MODEL	INTERCONNECTING CABLE WIRELESS (mm ²)	CIRCUIT BREAKER WITHOUT HEATING ELEMENT
KN 30	6x2.5	25A
KN 36	6x2.5	25A
KN 27	6x2.5	20A

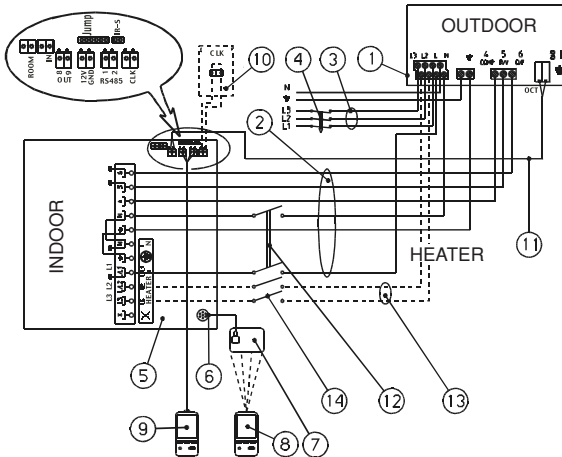

- | | |
|----------------------------|---|
| 1. Outdoor unit | 8. Wireless Remote Control |
| 2. Inter connecting cable | 9. Wired Remote Control (optional) |
| 3. Power supply | 10. Remote ON/OFF Switch (by installer) |
| 4. Semi-automatic switch | 11. Control Cable (Shielded) |
| 5. Indoor unit | 12. Switch ON/OFF (by installer) |
| 6. Display Quick connector | 13. Heater Cable (Optional) |
| 7. Display control unit | 14. Switch ON/OFF for Heater (by installer) |

MODEL	INTERCONNECTING CABLE WIRELESS (mm ²)	CIRCUIT BREAKER WITHOUT HEATING ELEMENT
KN 30	6x2.5	3x16A
KN 36	6x2.5	3x16A
KN 46	6x2.5	3x16A
KN 27	6x2.5	3x16A

Figure 35: Three Phase Units

3.2 Interconnecting cable

The electrical cable between the indoor and outdoor units, for all models, must be HO5VV-K5G-type. Conductors shall be of size and number as indicated in Figure 34, 35. The electrical cable must be one piece, without any joints. When installing the cable under the floor, it must be protected and isolated from any possible contact with water. When the cable path runs through a wall or an acoustic ceiling, it will be protected with fireproof tubing. In addition, the two units should be interconnected by a telephone type cable, 2X0.5mm². See applicable wiring diagram in Figure 34, 35.

TEST OPERATION

1. The test operation must be carried out after the entire installation has been completed.
2. Please confirm the following points before the test operation.
 - The indoor unit and outdoor unit are installed properly.
 - Tubing and wiring are correctly completed.
 - The refrigerant pipe system is leakage checked.
 - The drainage is unimpeded.
 - The ground wiring is connected correctly.
 - The length of the tubing and the added stow capacity of the refrigerant have been recorded.
 - The power voltage fits the rated voltage of the air conditioner.
 - There is no obstacle at the outlet and inlet of the outdoor and indoor units.
 - The gas-side and liquid-side stop valves are both opened.
 - The air conditioner is pre-heated by turning on the power .
3. According to the user's requirement, install the remote controller frame where the remote controller's signal can reach the indoor unit smoothly.
4. Test operation
 - Set the air conditioner under the mode of "COOLING" with the remote controller, and check the following points per the "Owner's manual". If there is any malfunction, please resolve it as per chapter "Troubles and Cause" in the "Owner's Manual".
 - 1) The indoor unit
 - a. Whether the switch on the remote controller works well.
 - b. Whether the buttons on the remote controller works well.
 - c. Whether the air flow louver moves normally.
 - d. Whether the room temperature is adjusted well.
 - e. Whether the indicator lights normally.
 - f. Whether the temporary buttons works well.
 - g. Whether the drainage is normal.
 - h. Whether there is vibration or abnormal noise during operation.
 - i. Whether the air conditioner heats well in the case of the HEATING /COOLING type.
 - 2) The outdoor unit
 - a. Whether there is vibration or abnormal noise during operation.
 - b. Whether the generated wind, noise, or condensed of by the air conditioner have influenced your neighborhood.
 - c. Whether any of the refrigerant is leaked.

CAUTION

A protection feature prevents the air conditioner from being activated fro approximately 3 minutes when it is restarted immediately after shut off.