

AIR CONDITIONER SPLIT WALL MOUNTED

ENGLISH

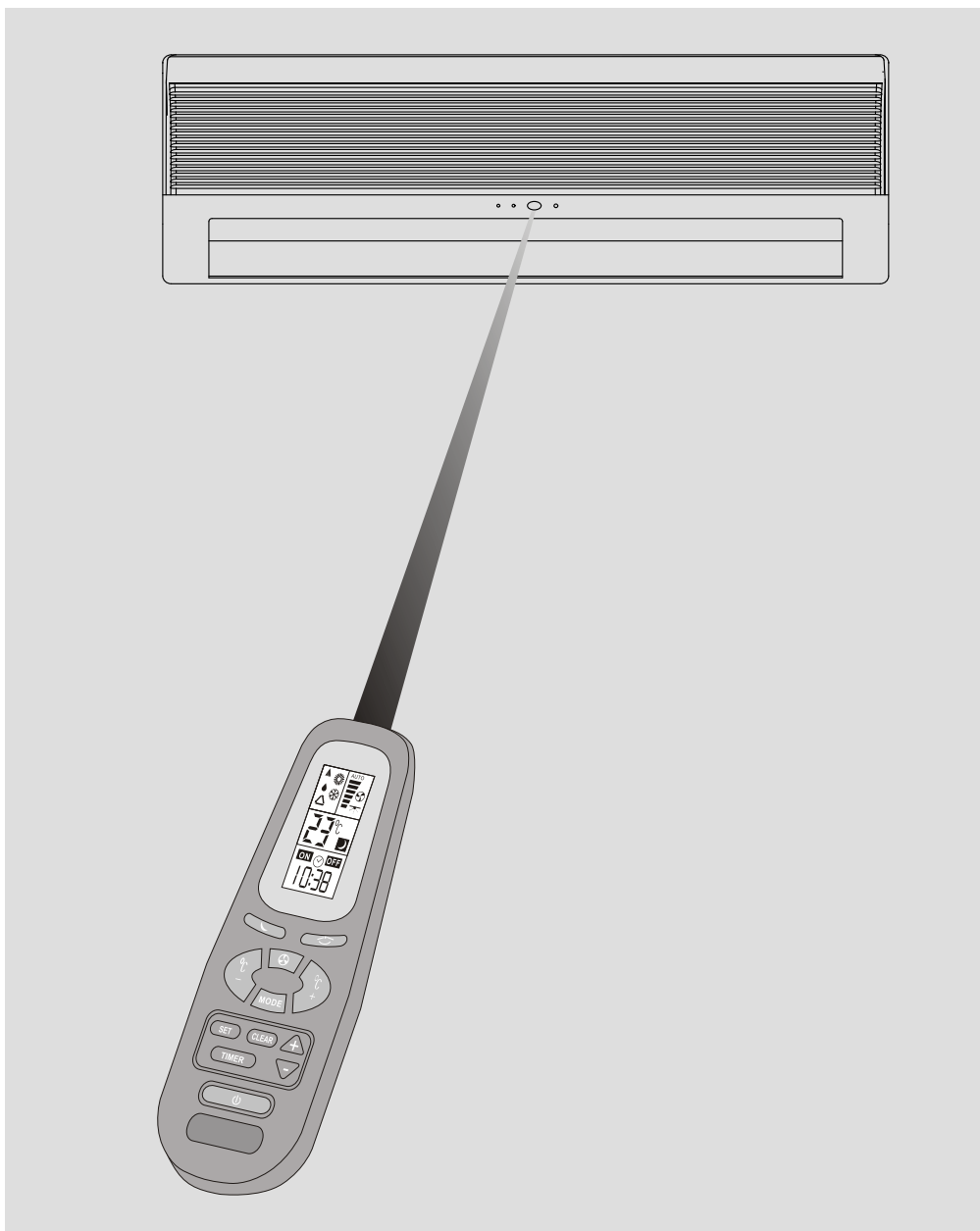

PROGRAMMING AND OPERATING MANUAL

Airwell

**AIR CONDITIONER
SPLIT WALL MOUNTED
PROGRAMMING
AND OPERATING**

ENGLISH

CONTENTS

INTRODUCTION	1
SYSTEM DESCRIPTION	2
OPERATION MODES, FUNCTIONS AND FEATURES	3
USE OF WIRELESS REMOTE CONTROL	5
ON-UNIT INDICATORS AND CONTROLS	6
REMOTE CONTROL	7
OPERATION PROCEDURE	8
• Turning on the air conditioner	8
• Ventilating operation	8
• Cooling operation	8
• Cooling operation with auto fan mode	8
• Heating operation	8
• Heating operation with auto fan mode	8
• Auto cooling / heating operation	9
• Dry operation	9
• Selecting the temperature	9
• Sleep function	9
• Timer operation	10
• Automatic vertical air swing	11
• Turning off the air conditioner	11
• Current clock time set	11
PROTECTION MODES	12
CARE AND MAINTENANCE	13
OPERATING TIPS	14
PRECAUTIONS	15
BEFORE CALLING FOR SERVICE	16

*IF YOUR AIR
CONDITIONER IS FOR
COOLING ONLY, PLEASE
DISREGARD THE
HEATING INSTRUCTIONS*

*PLEASE READ THESE
INSTRUCTIONS BEFORE
OPERATING THE AIR
CONDITIONER*

INTRODUCTION

This Split Air Conditioner is designed for versatile applications:



- Cooling air in the summer.
-



- Dehumidifying the air at high humidity conditions.
-



- Heating.
-



- Ventilation.
-

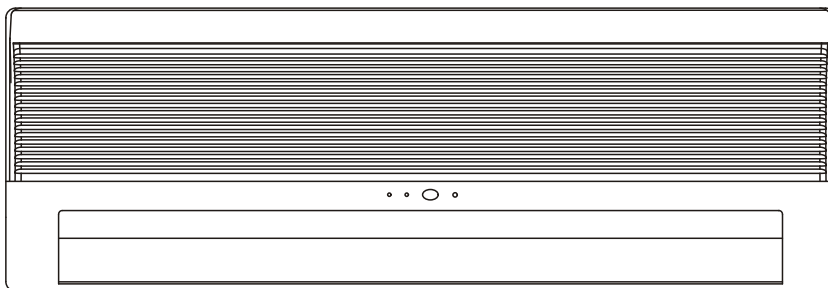

OPERATING TEMPERATURE RANGE:

(According to T_i temperature condition)

Cooling: 21-43 °C

Heating: -5-21 °C R22

-9-21 °C R407C & R410A

IMPORTANT NOTICE:

- This air conditioner must be grounded to protect against electrical shock.
- Installation of the air conditioner must be performed by an experienced air conditioning installer, observing good refrigeration practice.
- Electrical connections and power cord replacement should only be made by authorized electricians and in accordance with electrical regulations and local codes.
- Failure to comply with the manufacturer's installation and operation instructions could affect the performance of the air conditioner and the validity of the warranty.

SYSTEM DESCRIPTION

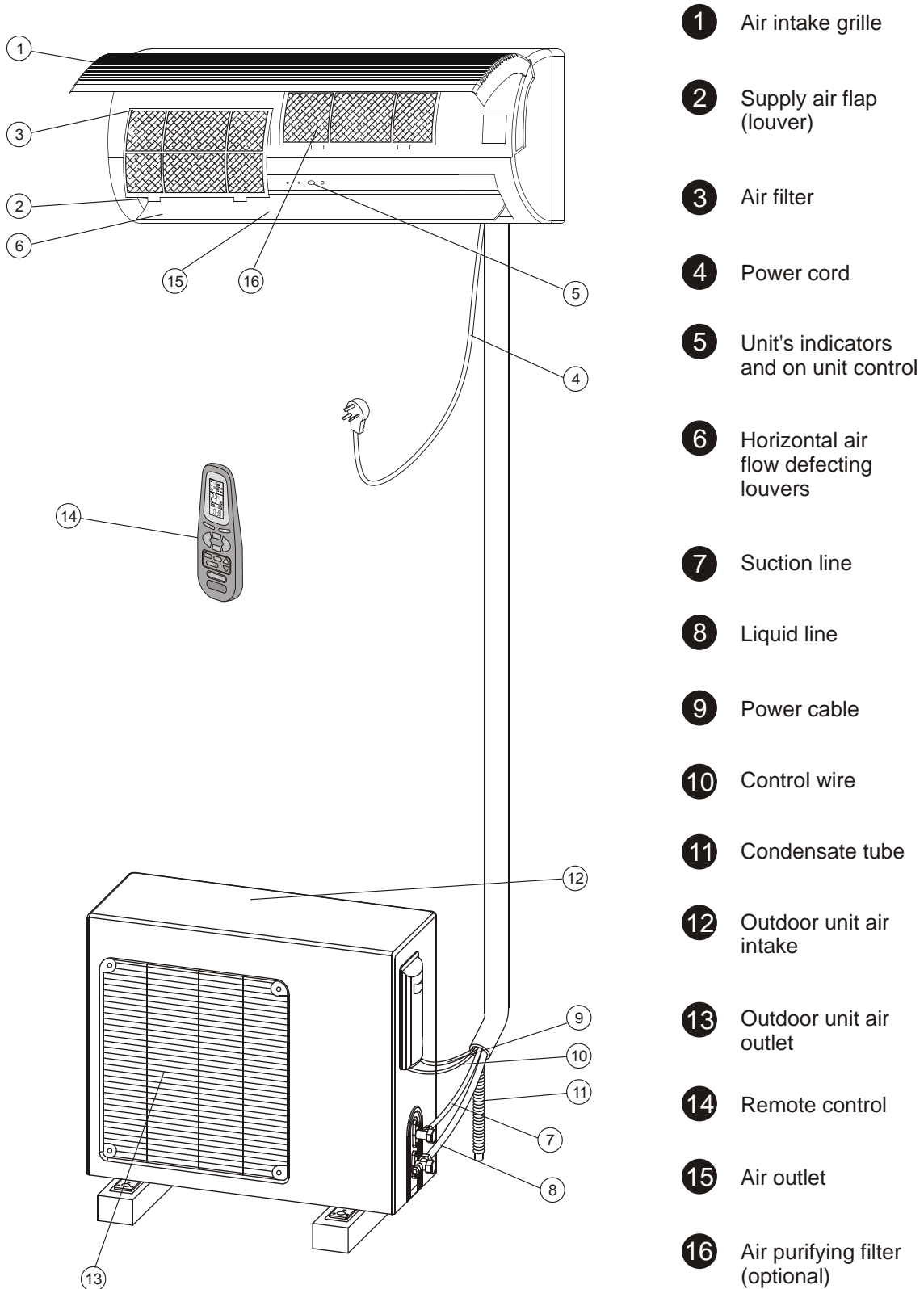

OPERATION MODES, FUNCTIONS AND FEATURES



COOL Cools, dehumidifies and filters the room air. Maintains the desired room temperature.



HEAT Heats and filters the room air. Maintains the desired room temperature.



AUTO Automatically switches from COOLING to HEATING or from HEATING to COOLING, maintaining the desired temperature according to the room conditions.



DRY Dehumidifies and softly cools the room. In DRY Mode, the air conditioner operates at an increased dehumidifying power. This function is recommended to be used when temperature is rather low but the humidity is high.



FAN Recirculates and filters the room air. Maintains constant air movement in the room.



AUTO FAN The air conditioner automatically selects the FAN speed in accordance to with the room temperature. At the start, the unit operates at high fan speed. As the room air approaches to the desired temperature, the fan switches to a lower speed for quieter operation.

HOT KEEP In HEATING and in AUTO FAN, the fan will be turned off when the compressor is not in operation and will not be restarted, unless the indoor coil reaches adequate temperature. This HOT KEEP feature prevents uncomfortable cold air drafts. Use of AUTO FAN is, therefore, recommended when the air conditioner is in HEATING mode.



TIMER Real time control and display, automatically turns the air conditioner ON and OFF according to the time of day setting, ensuring comfort conditions before returning home, without wasting electricity. It turns the air conditioner off automatically when sleeping.



Designed to create comfortable sleeping conditions. When in COOLING mode, the temperature rises one degree centigrade after each consecutive hour, up to three hours, from the start of the mode. The temperature rise prevents the feeling of over-cooling while sleeping (when your body is at rest). In HEATING mode the reverse occurs; the air conditioner lowers its temperature one degree every hour, up to three hours, from the start of the mode. When in SLEEP mode, the air conditioner will be automatically turned off after have operated for seven hours. The result is a more comfortable and invigorating sleep, which leaves you feeling fresh and energetic in the morning.

**AUTO
LOUVRE**

The air louvers is automatically positioned for the most suitable blow-out angle, when COOL, HEAT, DRY or FAN modes are selected. When the air conditioner is turned off, the flap will close automatically for an aesthetic appearance.



**VERTICAL
AIR SWING**

Automatic swing of supply air in vertical direction. The flap moves automatically in upward and downward direction to spread the conditioned air evenly throughout the room.



BUZZER

A soft buzzer will sound from the indoor unit display to indicate that a command sent by the remote control has been accepted and stored in the unit's memory.

**ON UNIT
OPERATION**

The air conditioner can be turned ON for COOLING or HEATING or be turned OFF directly from the indoor unit display panel without the use of the remote control.

**3-MIN
DELAYED RUN**

This compressor is protected by a three-minute delayed restart.

MEMORY

The microprocessor retains the last data entry whether or not the unit is plugged in. Therefore, when the unit restarts after a power disruption or failure, it will resume operating in the same mode as before the power was disrupted.

USE OF WIRELESS REMOTE CONTROL

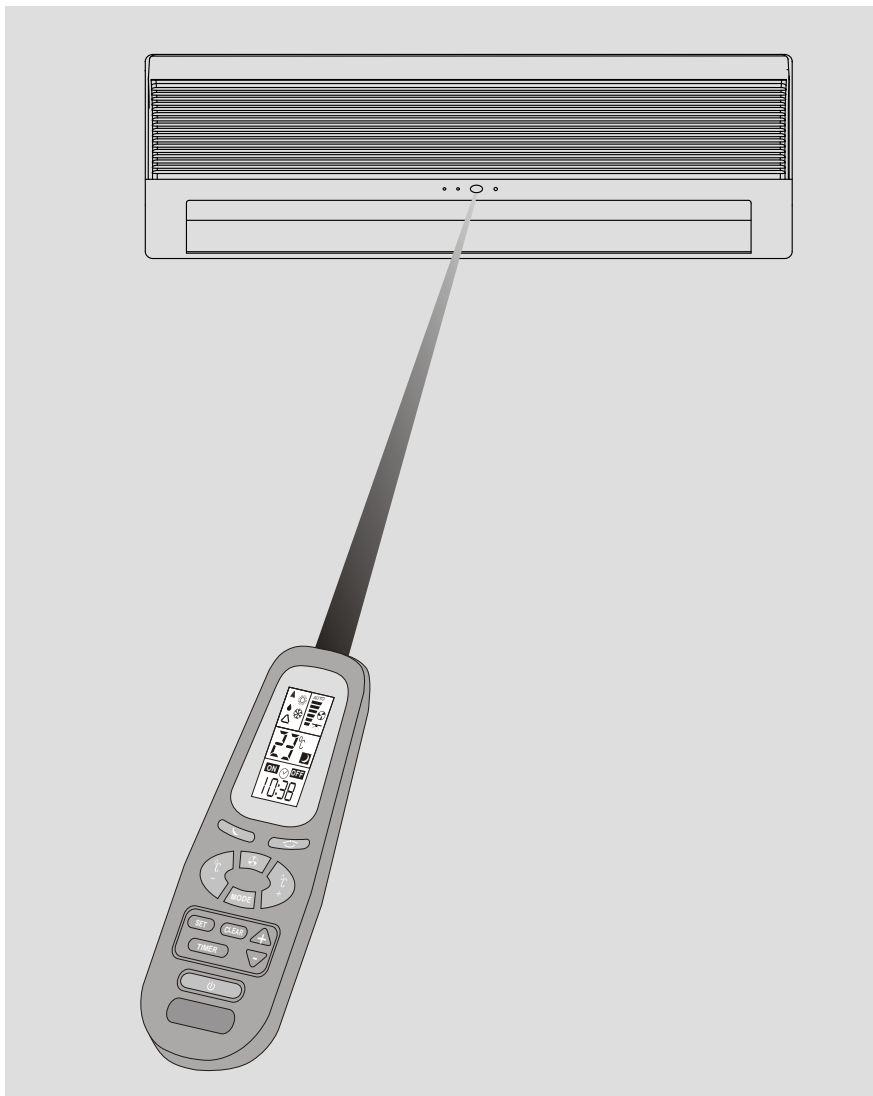

PRIOR TO OPERATION

Prior to operating your air conditioner, make sure that:

- The indoor unit is properly plugged into power.(Except for multi-split models).
- Indicator(A)on the unit's display is lit, meaning that the air conditioner is ready to accept your remote control commands.
- For clock setting, see page 11.

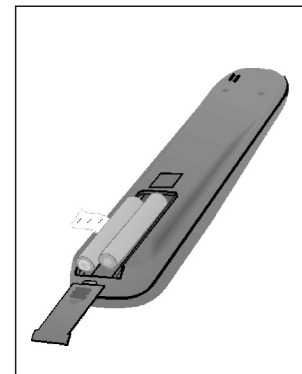

CARD TYPE REMOTE CONTROL PUTS ALL FUNCTIONS AT YOUR FINGERTIPS

- Aim at the infrared signal receiver on the room air conditioner when operating.
- The remote control signal can be received at a distance of up to about 7m.
- Be sure that there are no obstructions between the remote control and the signal receptor.
- Do not drop or throw the remote control.
- Do not place the remote control in a location exposed to direct sunlight, or next to a heating unit, and/or other heat source.
- Do not expose the air conditioner signal receiver(C)to a strong light such as fluorescent lamp or sunlight

ON-UNIT INDICATORS AND CONTROLS

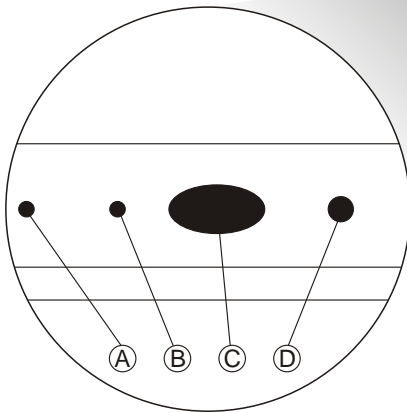
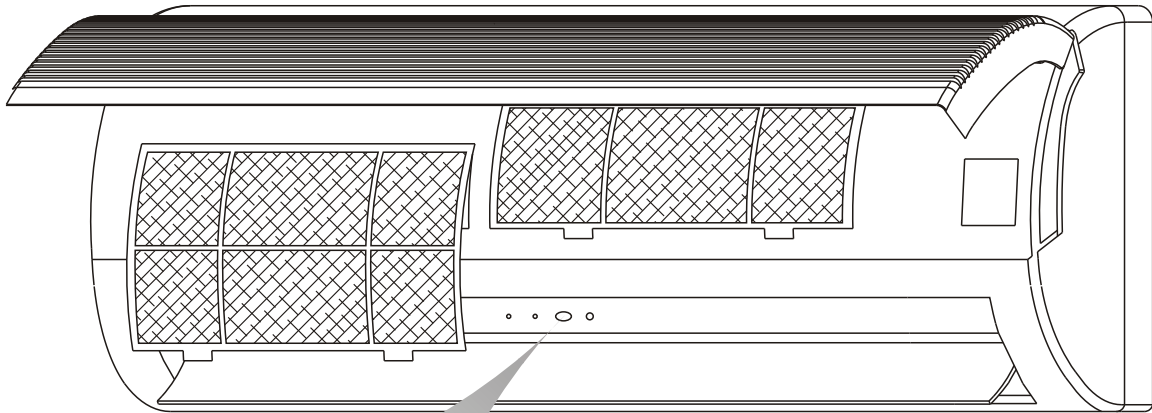

- A** **STAND-BY INDICATOR**
Lights up when the air conditioner is connected to power and ready to receive the remote control commands.
- B** **OPERATION INDICATOR**
Lights up during operation. Blinks once to announce that the remote control infrared signal has been received and stored. Blinks continuously in protection mode.
- C** **SIGNAL RECEIVER**
Receive signals from the remote control.
- D** **ON UNIT CONTROL**
Press to turn on or turn off for COOLING or HEATING without the use of remote control

REMOTE CONTROL

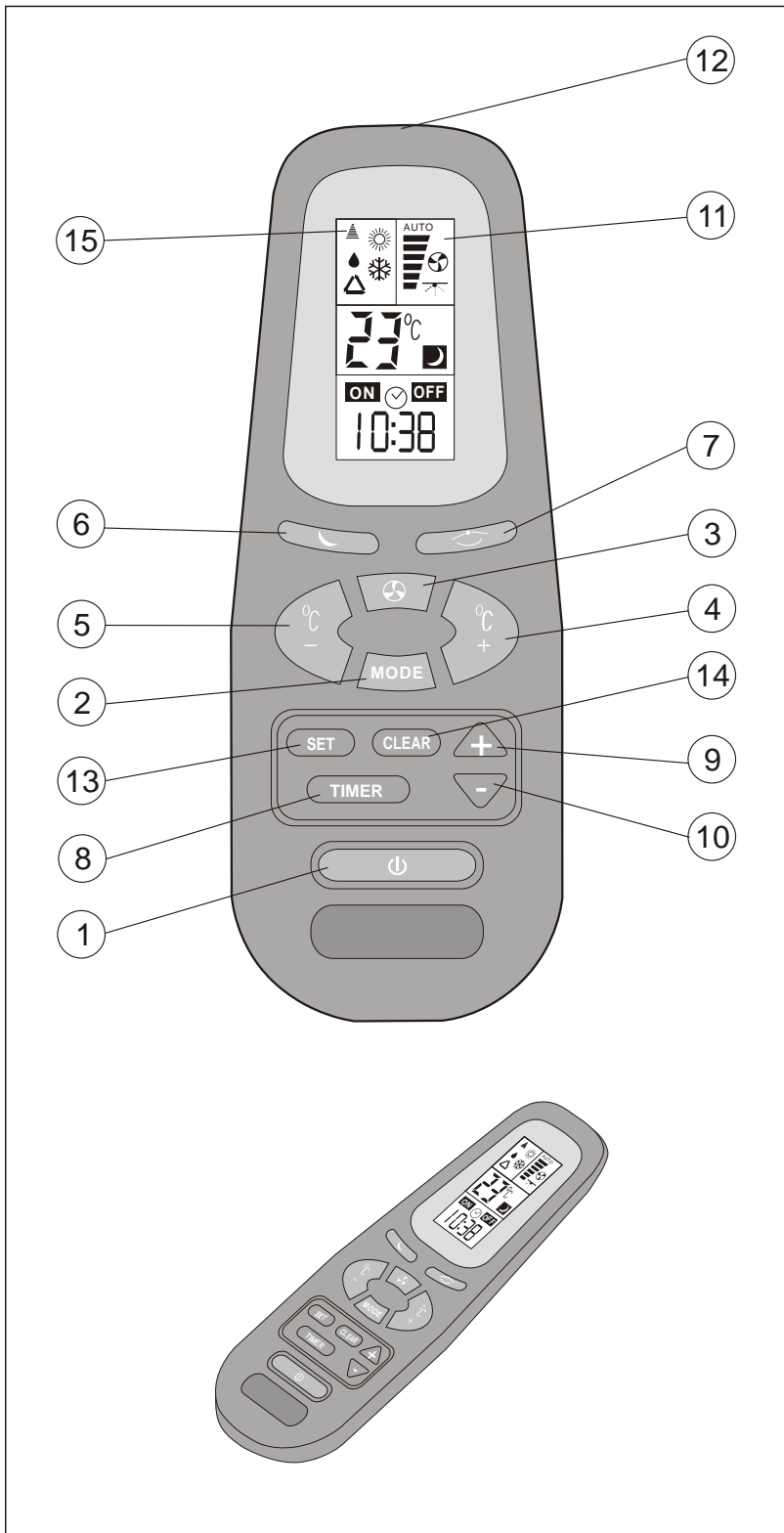

- ❶ START/STOP button
- ❷ Operation mode selection button
COOLING
HEATING
AUTO COOL/HEAT
DRY
FAN
- ❸ FAN SPEED and AUTO FAN button
- ❹ Setting point temperature UP button
- ❺ Setting point temperature DOWN button
- ❻ SLEEP button
- ❼ Airflow direction AUTO-CONTROL button
- ❽ TIMER button
- ❾ TIMER UP button
- ❿ TIMER DOWN button
- ⓫ LCD operation display
- ⓬ Infrared signal transmitter
- ⓭ TIMER SET button
- ⓮ TIMER CLEAR button
- ⓯ Transmission sign

OPERATION PROCEDURE

TURNING ON THE AIR CONDITIONER

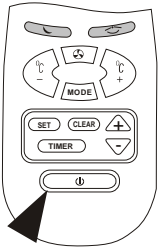

Press START/STOP button (1) to turn the air conditioner. After connecting to the power supply, The indicator (A) on the air conditioner light up, indicating that the air conditioner is in the standby status. Please note that LCD operation display (11) will always show the last mode of operation and the previous function used. If you want to change the control settings, proceed according to the following instructions. Otherwise, the air conditioner will start and operate in the same mode and functions prior to being turned off.

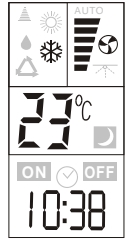

VENTILATING OPERATION

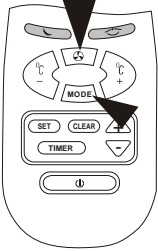

Select the ventilating mode by pressing MODE button (2). Switch to the desired fan speed by pressing FAN speed button (3).

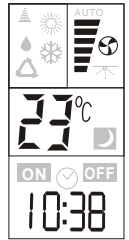

COOLING OPERATION

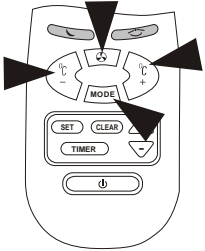

Select the COOLING mode by pressing MODE button (2). Switch to the desired FAN SPEED or to AUTO FAN by pressing button (3). Select suitable temperature setting. By selecting the COOLING mode, the air flap will move automatically to air delivery position, optimal for cooling.

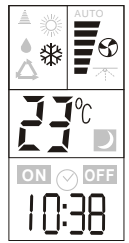

COOLING OPERATION WITH AUTO FAN MODE

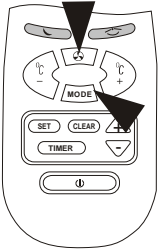

This operation starts with the highest air flow in order to quickly lower the room temperature. It will then automatically switch to the low air flow to quietly maintain the selected temperature.

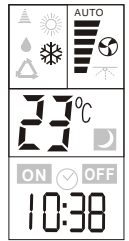

HEATING OPERATION

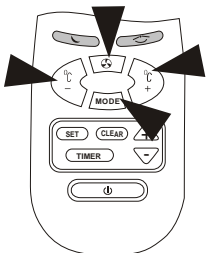

Select the HEATING mode by pressing MODE button (2). Switch to the desired FAN SPEED or to AUTO FAN by pressing FAN button (3). Select suitable temperature setting. By selecting the HEATING mode, the air flap will move automatically to air delivery position, optimal for heating.



HEATING OPERATION WITH AUTO FAN MODE

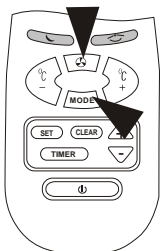

This operation starts with the highest air flow in order to quickly raise the room temperature. It will then automatically switch to a lower air flow to quietly maintain the selected temperature. HEATING with AUTO FAN will automatically provide the user with the HOT KEEP function. The fan will be turned off when the indoor coil temperature is not sufficiently hot to prevent uncomfortable cold air drafts.

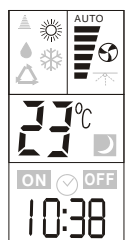

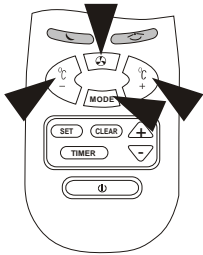

AUTO COOLING/HEATING OPERATION

Select the AUTO mode by pressing MODE button (2). Switch to the desired FAN SPEED or to AUTO FAN by pressing button (3). Select suitable temperature setting. The air flap will automatically move to either horizontal air delivery for cooling or to vertical air delivery for heating. At start, the air conditioner will select its mode of operation according to the room temperature and the temperature setting

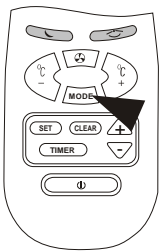

DRY OPERATION

Select the DRY mode by pressing MODE button (2). Select the suitable temperature setting. While in DRY mode, the air conditioner will operate at low fan speed, regardless of the fan setting on the LCD operation display. Fan might terminate operation from time to time to prevent from over cooling. By selecting the mode, the air flap will move automatically to optimal horizontal air delivery position.

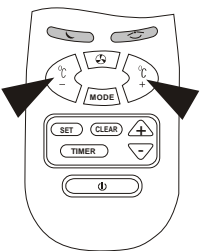
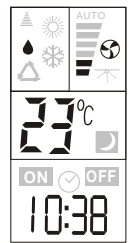

SELECTING THE TEMPERATURE

Press TEMP button (4) or (5) to change the temperature setting in the LCD operation display(11).The temperature setting is shown in degrees centigrade. A higher number indicates a higher room temperature. A lower number indicates a lower room temperature.

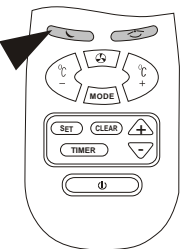

SLEEP FUNCTION

Press the SLEEP button (6) to select the SLEEP function. When the sleep function is activated the air conditioner will be automatically turned OFF after seven hours. If at the same time TIMER is activated, as well ,the air conditioner will be turned ON and OFF according to the TIMER setting.

To cancel the SLEEP function press on one of the following:

- START/STOP button (1)
- SLEEP button (6)

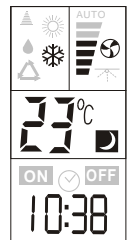

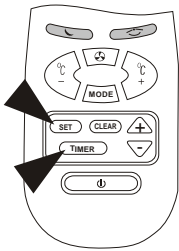

TIMER OPERATION

Press TIMER select button (8) to activate the timed operation mode. Each time you press TIMER button (8) is pressed, one of the following four type of operation modes will appear on the LCD display. The operation modes are sequenced in turn in the direction of arrow.

Note: After power failure when the unit is in timer mode indicator (B) will be blinking and the unit will be automatically turned to stand-by mode and the timer operation will be cancelled. To resume the timer wait 30 sec. before reprogramming. Follow the instructions above.



TIMER OPERATING MODES

I. TIMER ON

This mode enables you to set a start operating time. Press the TIMER button (8) till ON sign blinks. Start time can be adjusted using up and down buttons (9) and (10) respectively. Press SET button (13) to activate the timer.

Example: Operation is restored at 10:30 a.m.

II. TIMER OFF

This mode enables you to set the stop time of operation. Press the Timer button (8) till the OFF sign blinks. Time can be adjusted using up and down buttons (9) and (10) respectively. Press Set button (13) to activate the timer.

Example: Operation stops at 18:00.

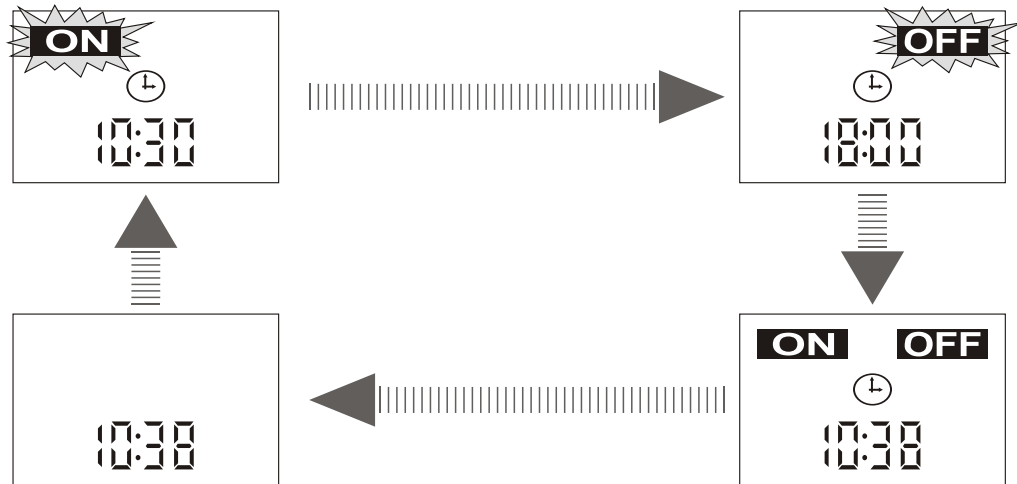

IV. CLEAR

Use this mode to cancel timer operation. Press CLEAR button (14), timer operation will terminate and the LCD display will be cleared for each timer mode.

Note: If timer button (8) is selected and neither time adjust, SET, or CLEAR buttons are not pressed within 15 seconds; the timer operation will be cancelled and the last setup will be displayed

III. TIMER ON/OFF

This mode enables you to set the start and stop time of operation. Press Timer button (8) till the ON sign blinks. By pressing again the OFF sign blinks. By press again the ON sign blinks. Time can be adjusted by using the up and down buttons (9) and (10) respectively. Press Set button (13) to activate the timer.

Example: Operation is restored at 10:30 a.m. Operation stops at 18:00

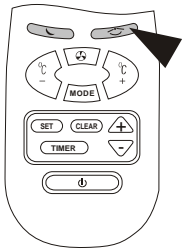

AUTOMATIC VERTICAL AIR SWING

Press button (7) to activate the auto air swing. By Pressing button (7) again you can stop the auto swing and position the air flap at any desired anle.

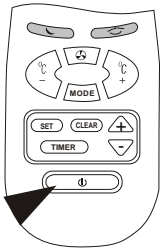
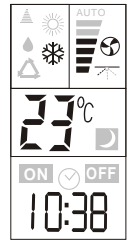

TURNING OFF THE AIR CONDITIONER

Press START/STOP button (1) to turn off the air conditioner. Indicator (B) on the air conditioner will be turned off. Indicator (A) will stay lit, indicating that the air conditioner is in STAND-BY mode and ready to accept any new command from the remote control. The remote control LCD will display the clock time. The last operating set-up will be kept for the next operation.

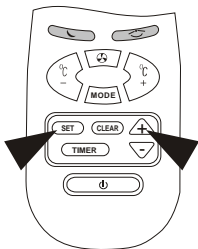
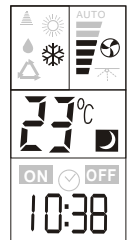

CURRENT CLOCK TIME SET

Clock setting is performed when batteries are inserted. The remote control displays the setting and the clock display will blink "0:00" or "12:00" AM (AM sign will blink, too) till a new time is set.

For clock setting, use buttons (9) and (10) for setting the hours and minutes, respectively, and then press timer SET button (13). The clock setting can be also performed by pressing time SET button (13) for 5 seconds.

The clock display will blink, for new setting follow the steps described above.

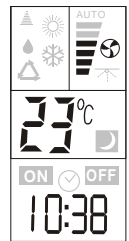

PROTECTION MODES

Your air conditioner includes several automatic protection modes, which enables you to use it virtually at any time and in any season, regardless of the outdoor temperature. Some of the protection modes are listed below:

Mode	Operation conditions	Protection from	Controlled remedy
Cooling	Low outdoor temperature	Indoor coil freezes up	Stops outdoor fan and compressor when approaching freezing conditions Resumes operation automatically.
	High outdoor temperature	Outdoor coil overheating	Stops compressor when approaching over heating conditions. Resumes operation automatically. Operation button (B) blinks.
Heating	Low outdoor temperature	Outdoor coil ice build up	Reverses Operation from heating to cooling for short periods to de-ice outdoor coil. Operation button (B) blinks.
	High indoor or outdoor temperature	Indoor coil overheating	Stops outdoor fan and compressor when approaching high indoor coil temperature. Resumes operation automatically.

CARE AND MAINTENANCE

Before performing any maintenance procedure, make sure to disconnect the air conditioner from the power.

CLEANING THE AIR FILTER

- To remove the air filters lift up the panel. Push the air filters up slightly to unlock them. Pull out the filters clean the filter by washing in warm soapy water and dry thoroughly Align and fit the filters in place. Close the panel by pushing it in the center to lock it in place.

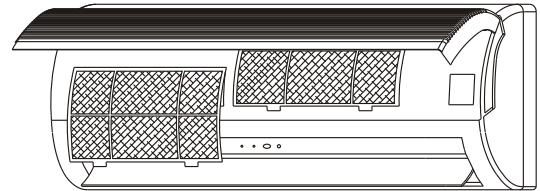

PURIFICATION FILTER REPLACEMENT

The air purifying filter should be removed from the unit and replaced once a year, as shown in figures 1,2 and 3.

- ① Pulling out the filter
- ② Replacing and securing the filter in its frame
- ③ Sliding the filter back in its place

Note: The above procedure is used for replacing the active carbon filter (when supplied).

DO NOT OPERATE THE UNIT WITHOUT FILTERS!

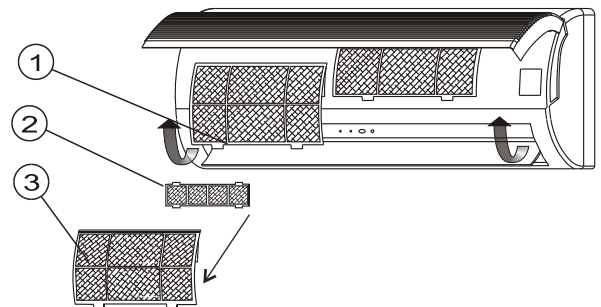

CLEANING THE AIR CONDITIONER

- Wipe the unit with a soft dry cloth or clean it using a vacuum cleaner.
- Do not use hot water or volatile materials which could damage the surface of the air conditioner.

AT THE BEGINNING OF THE SEASON

- Make sure there are no obstacles blocking the flow of inlet or outlet air, in both indoor and outdoor units.
- Make sure the power is properly connected.

PROTECT THE ELECTRONIC SYSTEM

- Indoor unit and remote control must be at least 1 meter away from a TV, radio or any other home electronic appliance.
- Protect the inner unit from direct sun or lighting.

REMOTE CONTROL BATTERY CHANGE

- Remove the batteries from the remote control as shown.
- Use two 1.5 volt size AAA batteries

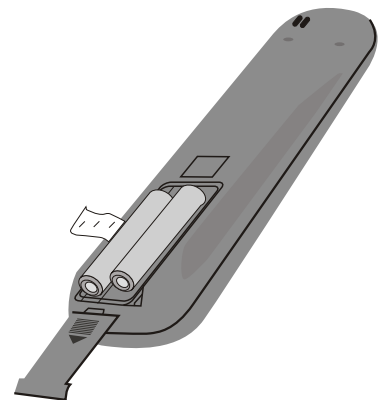

OPERATING TIPS

- Set a suitable room temperature; excessively low room temperature is not good for your health and wastes electricity. Avoid frequent setting of the temperature.
- During cooling, avoid direct sun. Keep curtains and blinds closed. Close doors and windows to keep the cool air in the room.
- Avoid generating heat or using of heating appliances while the air conditioner in cooling mode.
- Make sure that the air flap is positioned properly: horizontal flow in cooling and downward vertical flow for heating.
- Keep the room temperature uniform by adjusting the left/right vertical air blades.
- Position the air flap and the left/right air blades in such a manner as to prevent your body from being exposed directly to air drafts.
- During prolonged operation, ventilate the room occasionally by opening a window from time to time.
- In a power failure, the microprocessor memory is retained. When restarted, operation will be resumed in the last mode of operation.
- After turning on, allow more than 3 minutes for cooling, heating or dry operation to start.
- When COOL modes are used, make sure that the room's relative humidity is below 78%. If the unit is used for a prolonged periods of time in high humidity, moisture may form on the air outlet and drip down.
- Remote control signals may not be received if the indoor unit controls cover is exposed to direct sunlight or strong light. In such a case, block the sunlight or dim the lighting.
- The remote control is operative in a range of 7 meters. If you are out of range, the remote control may have difficulties in transmitting signals.

PRECAUTIONS

- Use the proper electrical fuse.
Do not pull out the power cord unless the unit is turned off.

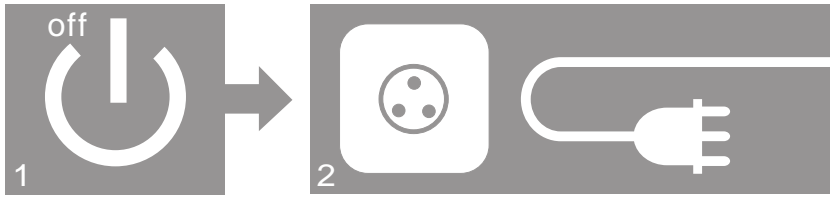

- Do not start or stop operation by disconnecting the power cord.

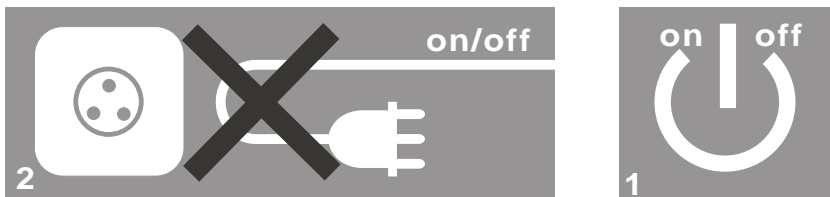

- Do not obstruct or block the air inlet or air outlet of the air conditioner.

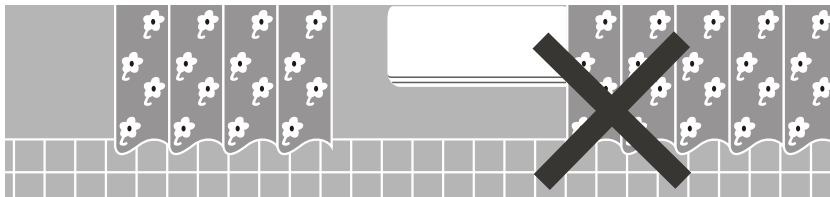

- Do not insert any objects in the air outlet of the indoor or outdoor units.



- Do not splash water on the air conditioner.



IF NOISE IS HEARD

There may be hissing sound during operation or just after shut down.

This is caused by the refrigerant that is circulating inside the unit.

There may be a cracking sound at starting and stopping the unit's operation. This is caused by heat expansion or contraction of plastics.

BEFORE CALLING FOR SERVICE

Before calling for service, please check the following common malfunctions and correct as needed.

Problem	Cause	Remedy
<ul style="list-style-type: none"> Unit does not operate. Stand-by indicator does not light up 	<ul style="list-style-type: none"> Unit not connected to power Power failure 	<ul style="list-style-type: none"> Plug in the power cord Check main fuse
<ul style="list-style-type: none"> Unit does not operate. Stand-by indicator lights. 	<ul style="list-style-type: none"> Remote control malfunctions 	<ul style="list-style-type: none"> Check remote control batteries Try to operate from a closer distance Start from on-unit controls
<ul style="list-style-type: none"> Unit does not respond properly to remote control command 	<ul style="list-style-type: none"> IR signal does not reach unit Distance between remote control and unit too large or aimed at from improper angle IR receiver on-unit exposed to strong light source 	<ul style="list-style-type: none"> Check for obstruction between unit and remote control. Clear if needed. Get closer to unit. Dim lights, fluorescent especially
<ul style="list-style-type: none"> Air does not blow out from indoor unit 	<ul style="list-style-type: none"> De-icing protection mode is activated 	<ul style="list-style-type: none"> Normal operation in HEATING mode
<ul style="list-style-type: none"> COOLING, DRY or HEATING does not start immediately 	<ul style="list-style-type: none"> 3-min. Compressor delayed start 	<ul style="list-style-type: none"> Normal operation for these modes
<ul style="list-style-type: none"> Unit functions but does not perform sufficiently 	<ul style="list-style-type: none"> Improper temperature setting Unit capacity insufficient for load or room size 	<ul style="list-style-type: none"> Reset temperature Consult your dealer

