

AIR CONDITIONER SPLIT WALL MOUNTED

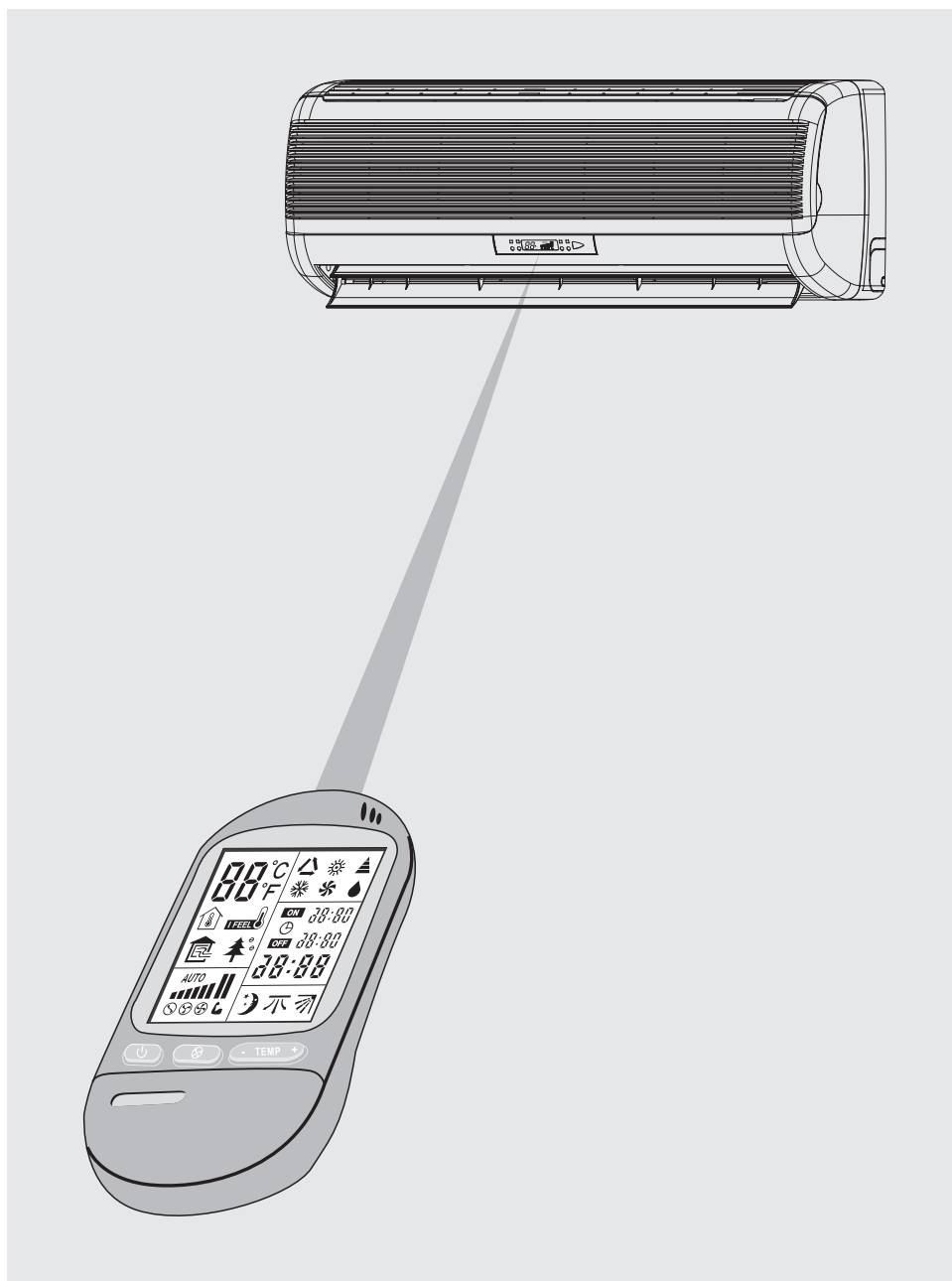

PROGRAMMING AND OPERATING MANUAL INSTALLATION INSTRUCTIONS

CONTENTS

Introduction	1
System Description	2
Modes of Operation, Functions and Features	3
Use of Wireless Remote Control	5
On-unit indicators and controls	6
Remote Control	7
Operation procedure	8
•Turning on the Air Conditioner	8
•Ventilating Operation	8
•Cooling Operation	8
•Cooling Operation with Auto Fan Mode	8
•Heating Opeeration	8
•Heating Operation With Auto Fan Mode	8
•Auto Cooling / Heating Operation	9
•Dry Operation	9
•Selecting The Temperature	9
•I FEEL Function	9
•Sleep Function	9
•Timer Operation	10
•Timer Operating Modes	10
•Room Temperature Display	10
•Air Direction Operation	11
•Turning off the Air Conditioner	11
•On unit Operation	11
•Current Clock Time Set	11
•Lock Function	11
•Fresh Air Function	12
•Ionizer and Electrostatic Filter	12
•Strong Function	12
Protection Modes	13
Care and Maintenance	14
Operating Tips	15
Precautions	16
Before Calling For Service	17

If your air conditioner is for cooling only, please disregard the heating instructions

Please read these instructions before operating the air conditioner

INTRODUCTION

This Split Air Conditioner is designed for versatile applications:



- Cooling in summer.



- Dehumidifying at high humidity conditions.



- Heating.



- Air Filtration



- Ventilation
-

OPERATING TEMPERATURE RANGE:
(According to T_1 temperature condition)

Cooling: 21° ~ 43°C

Heating: -7° ~ 21°C

IMPORTANT NOTICE:

- The air conditioner must be grounded to protect against electrical shock.
- Installation of the air conditioner must be performed by an experienced air conditioning installer, observing good refrigeration practice.
- Electrical connections and power cord replacement should only be made by authorized electricians and in accordance with electrical regulations and local codes.
- Failure to comply with the manufacturer's installation and operation instructions could affect the performance of the air conditioner and the validity of the warranty.

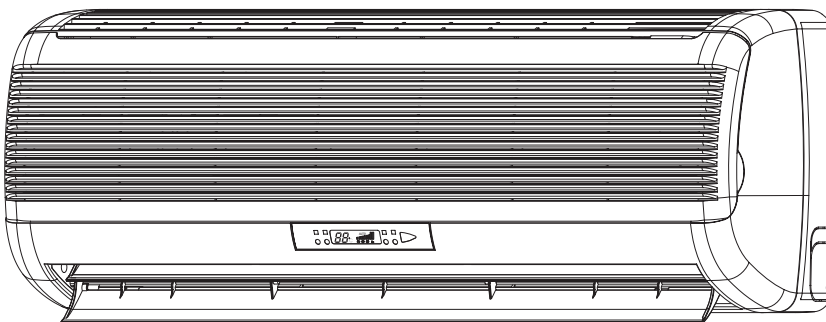

SYSTEM DESCRIPTION

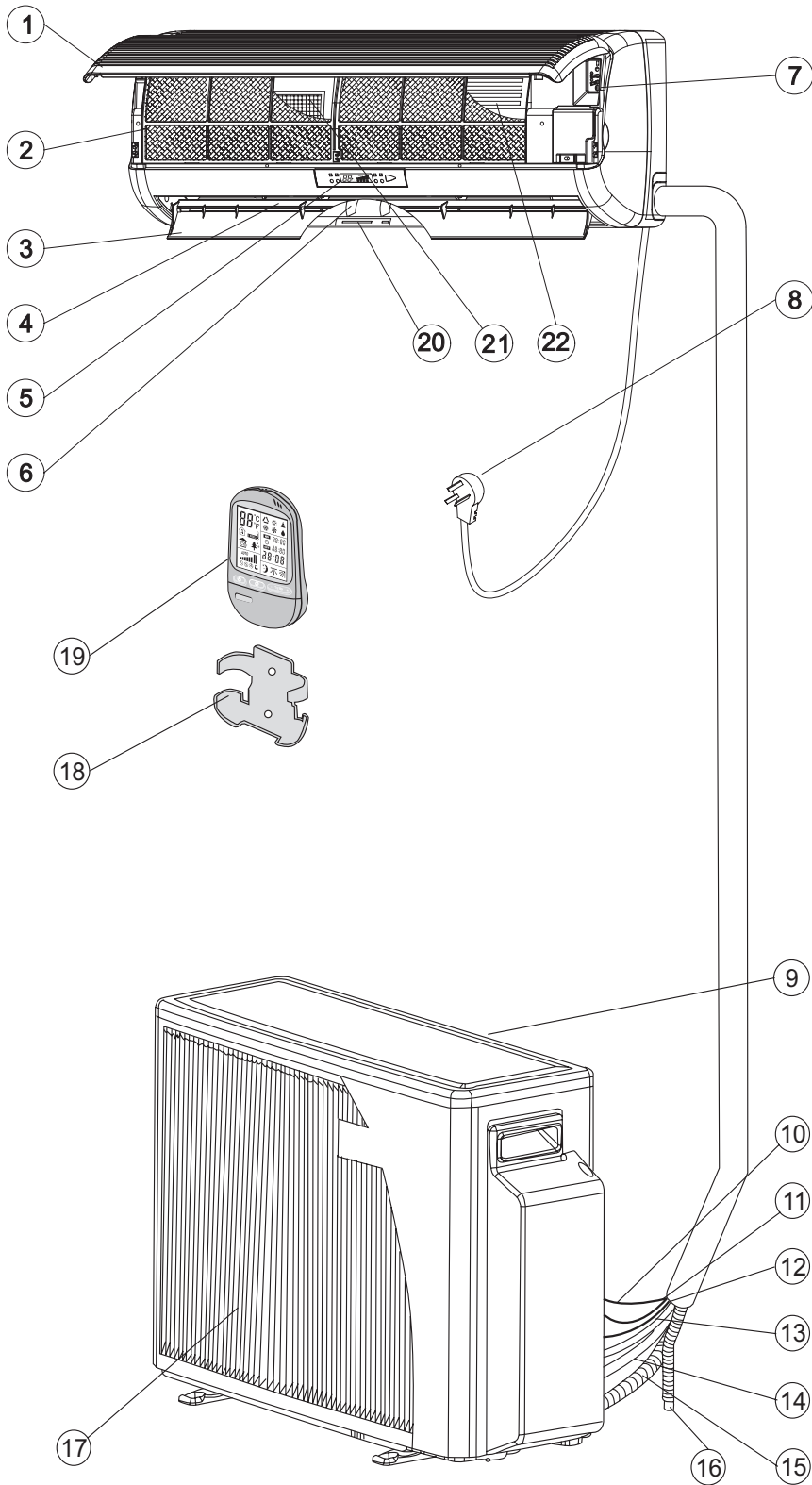

- 1. Air intake grille
- 2. Air filter
- 3. Supply air flap
- 4. Air outlet
- 5. Unit's indicators
- 6. Horizontal Air flow Deflecting lovers
- 7. On unit's controls
- 8. Power cord
- 9. Outdoor unit air intake
- 10. Power cable
- 11. control wire
- 12. Air-fresh controls wire (optional)
- 13. Liquid line
- 14. Suction line
- 15. Air-fresh hose (optional)
- 16. Drain hose
- 17. Outdoor unit air outlet
- 18. Remote controls holder
- 19. Remote control
- 20. Ionizer (optional)
- 21. Air purifying filter
- 22. Electrostatic filter (optional)

MODES OF OPERATION, FUNCTIONS AND FEATURES



COOL

Cools, dehumidifies and filters the room air. Maintains desired room temperature.



HEATING

Heats and filters the room air. Maintains the desired room temperature.



AUTO

Automatically switches from COOLING to HEATING or from HEATING to COOLING, maintaining the desired temperature according to the room conditions.



DRY

Dehumidifies and softly cools the room. In DRY Mode, the air conditioner operates at an increased dehumidifying power. This function is recommended to be used when temperature is rather low but the humidity is high.



FAN

Recirculates and filters the room air. Maintains constant air movement in the room.



AUTO FAN

The air conditioner automatically selects the FAN speed in accordance to the room temperature. At the start, the unit operates at high fan speed. As the room air approaches to the desired temperature, the fan switches automatically to a lower speed for quieter operation.

HOT KEEP

In HEATING and in AUTO FAN, the fan will be turned off when the compressor is not in operation and will not be restarted, unless the indoor coil reaches adequate temperature. This HOT KEEP feature prevents uncomfortable cold air drafts. Use of AUTO FAN is, therefore, recommended when the air conditioner is in HEATING mode.



I FEEL

Switches the temperature sensing point to the place where the remote control is located. (For general air conditioner, the temperature sensor is only located behind the air intake grille). This function is designed to provide a personalized by transmitting the temperature control command from the location Remote Control and the unit is done by infra-red signal. Therefore, in using next to you. The communication between the Remote Control and the unit is done by infra-red signal. Therefore, in using this function, the Remote Control should always be aimed, without obstructions at the air conditioner.



TIMER

Real time control and display, automatically turns the air conditioner ON and OFF according to the time of day setting, ensuring comfort conditions before returning home, without wasting electricity. It turns the air conditioner off automatically when sleeping.



SLEEP

Designed to create comfortable sleeping conditions. When in COOLING mode, the temperature rises one degree centigrade after each consecutive hour, for to three hours, from the start of the mode. The temperature rise prevents the feeling of over-cooling while sleeping (when your body is at rest). In HEATING mode the reverse occurs; the air conditioner lowers its temperature one-degree every hour. When in SLEEP mode, the air conditioner will be automatically turned off after have operated for seven hours. The result is a more comfortable and invigorating sleep, which leaves you feeling fresh and energetic on the next morning.



% RH HUMIDITY MEASUREMENT (OPTIONAL)	Measures and displays relative humidity between 30% and 90% at a temperature range of 15°C to 45°C.
AUTO FLAP	The air flap (louvers) is automatically positioned for the most suitable blow-out angle, when COOL, HEAT, DRY or FAN modes are selected. When the air conditioner is turned off, the flap will close automatically for an aesthetic appearance.
VERTICAL AIR SWING	Automatic swing of supply air in vertical direction. The flap moves automatically in upward and downward direction to spread the conditioned air evenly throughout the room.
HORIZONTAL AIR SWING	Automatic swing of Horizontal air flow in Horizontal direction. The flap move automatically in right and left direction to spread the conditioned air evenly throughout the room.
ROOM TEMPERATURE	Measures and displays room temperature.
FILTER INDICATION	Filter indicator on the indoor unit display is turned on when the filter requires cleaning. After cleaning and reinstalling the filter, the system should be reset.
BUZZER	A soft buzzer will sound from the indoor unit display to indicate that a command sent by the remote control has been accepted and stored in the unit's memory. This feature may be easily cancelled by the user from the display panel.
ON UNIT OPERATION	The air conditioner can be turned ON for COOLING or HEATING or be turned OFF directly from the indoor unit display panel without the use of the remote control.
3-MIN DELAYED RUN	This compressor is protected by a three-minute delayed restart.
LOCK	Freezes the last operation setting on the remote control. When LOCK is activated, the remote control will not be able to control the air-conditioner.
MEMORY	The microprocessor retains the last data entry whether or not the unit is plugged in. Therefore, when the unit restarts after a power disruption or failure, it will resume operating in the same mode as before the power was disrupted.
ILLUMINATED KEYPAD AND LCD DISPLAY (OPTIONAL)	By pressing any button in dark environment, the keypad and the LCD display will be illuminated.
ELECTROSTATIC FILTER (optional)	They are capable of capturing small particles down to 0.1 microns, Such as atmospheric and house hold dust, coal dust, insecticide dust, mites, pollen, pet dander, tobacco soot particles, cooking smoke and grease, mold fungi, bacteria, viruses and more.
IONIZER (optional)	Ionizer make the air more fresh and more comfort. Slide switch (H) to the ON position to activate the ionizer. The blue light indicator (G) on the unit will light up indicating the ionizer in operation. To cancel the operation set slide switch to OFF position. Important Notice: When the air-conditioner is turned OFF or if the indoor fan stops operation the IONIZER stops automatically.

USE OF WIRELESS REMOTE CONTROL

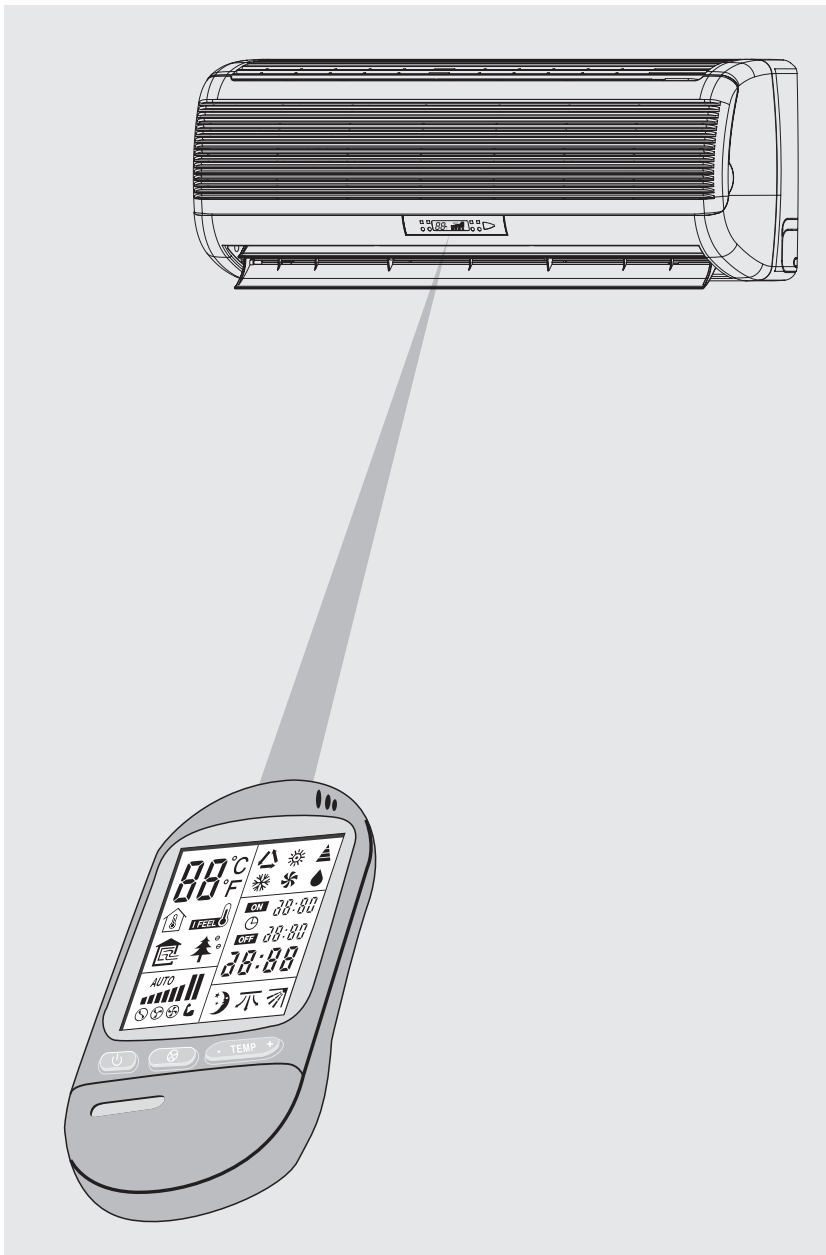

WIRELESS REMOTE CONTROL PUTS ALL FUNCTIONS AT YOUR FINGERTIPS.

- Aim at the infrared signal receiver on the room air conditioner when operating.
- The remote control signal can be received at a distance of up to about 8m.
- Be sure that there are no obstructions between the remote control and signal receiver.
- Do not drop or throw the remote control.
- Do not place the remote control in a location exposed to direct sunlight, or next to a heating unit, and/or other heat sources.
- Do not expose the signal receiver (F) on the display panel of the air conditioner to a strong light such as fluorescent lamp or sunlight.

PRIOR TO OPERATION

Prior to operating your air conditioner, make sure of the following procedures:

- Insert the plug of indoor unit to power supply properly.
- Indicator (A) on air conditioner lights on, indicating air conditioner is ready to receive signals from remote control.
- The red tab protecting the remote control batteries has been removed.
- For clock setting, see page 11.

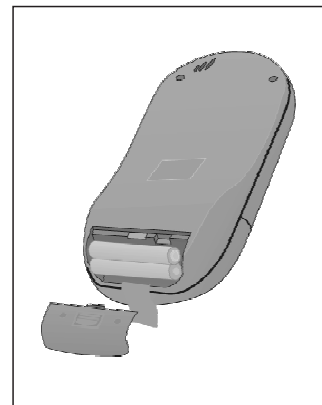

REMOTE CONTROL HOLDER

Use the remote control in the holder when unit is not in use. Remote control can be slipped in or out of its holder.

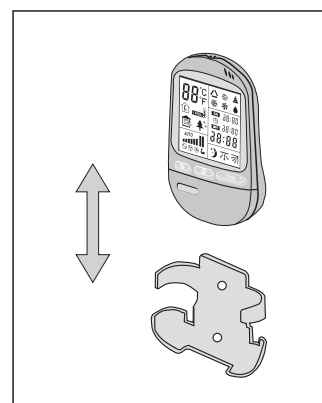

ON-UNIT INDICATORS AND CONTROLS

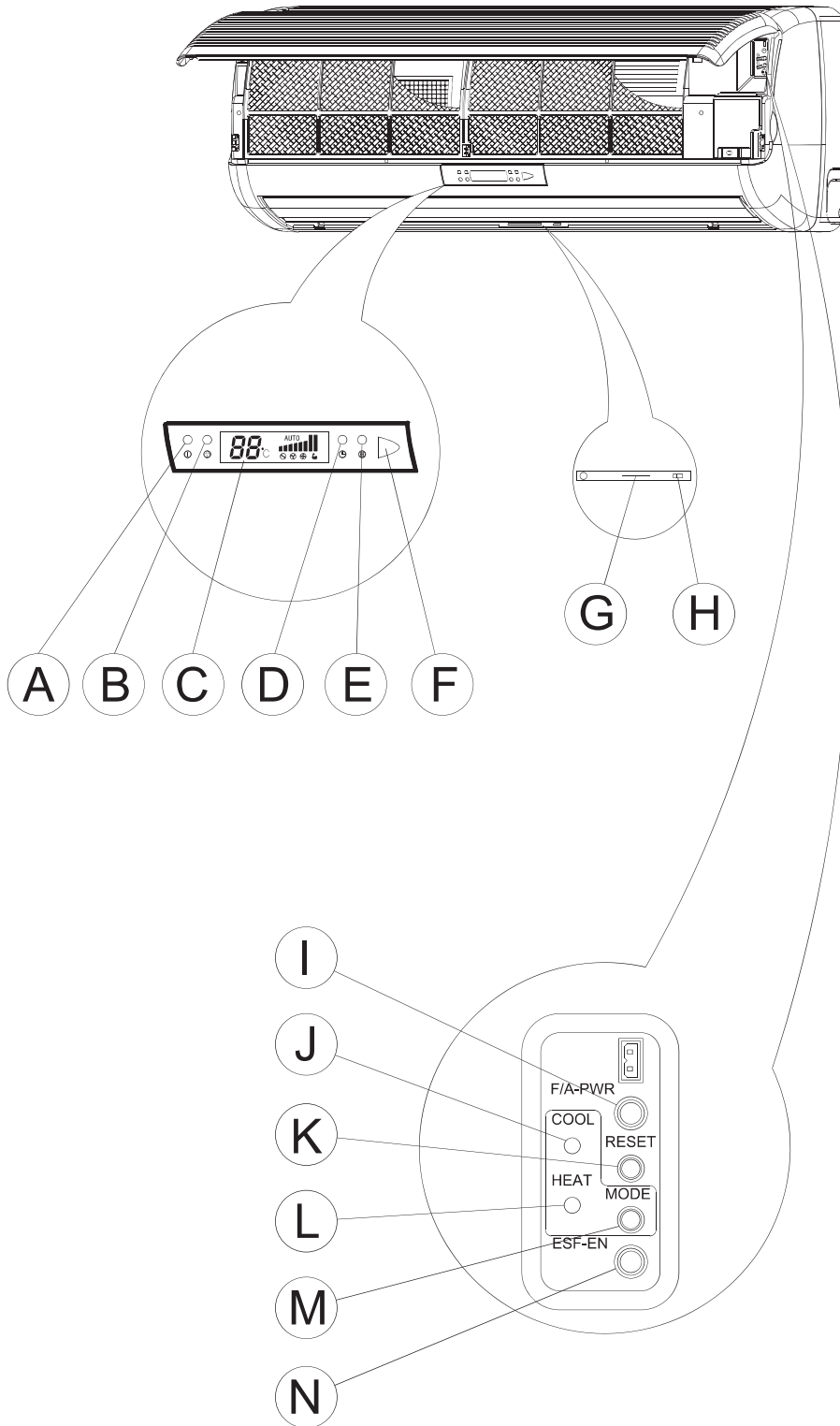

- A. Stand-by / Operation indicator
*Lights up in red when connected to power.
Lights up in blue during operation.*
- B. Fresh-air / Ionizer indicator
Lights up when the fresh-air or ionizer operation.
- C. LCD operation display
- D. Timer indicator
Lights up during timer and sleep operation.
- E. Filter indicator
Lights up when air filter requires cleaning.
- F. Signal receiver
Receiver signals from the remote control.
- G. Ionizer indicator
Lights up during the ionizer is open.
- H. Ionizer on/off
Used to switch the ionizer.
- I. Fresh-air on/off
- J. Cooling indicator
Lights up only when mode (M) is pressed.
- K. Reset button
Press to turn off the filter indicator or cancel the buzzer announcer.
- L. Heating indicator
Lights up when mode (M) is pressed.
- M. Unit mode button
Used to switch the unit for cooling or heating without the remote control.
- N. Electrostatic filter safety button
Turn off the Electrostatic filter when you open the grille.

REMOTE CONTROL

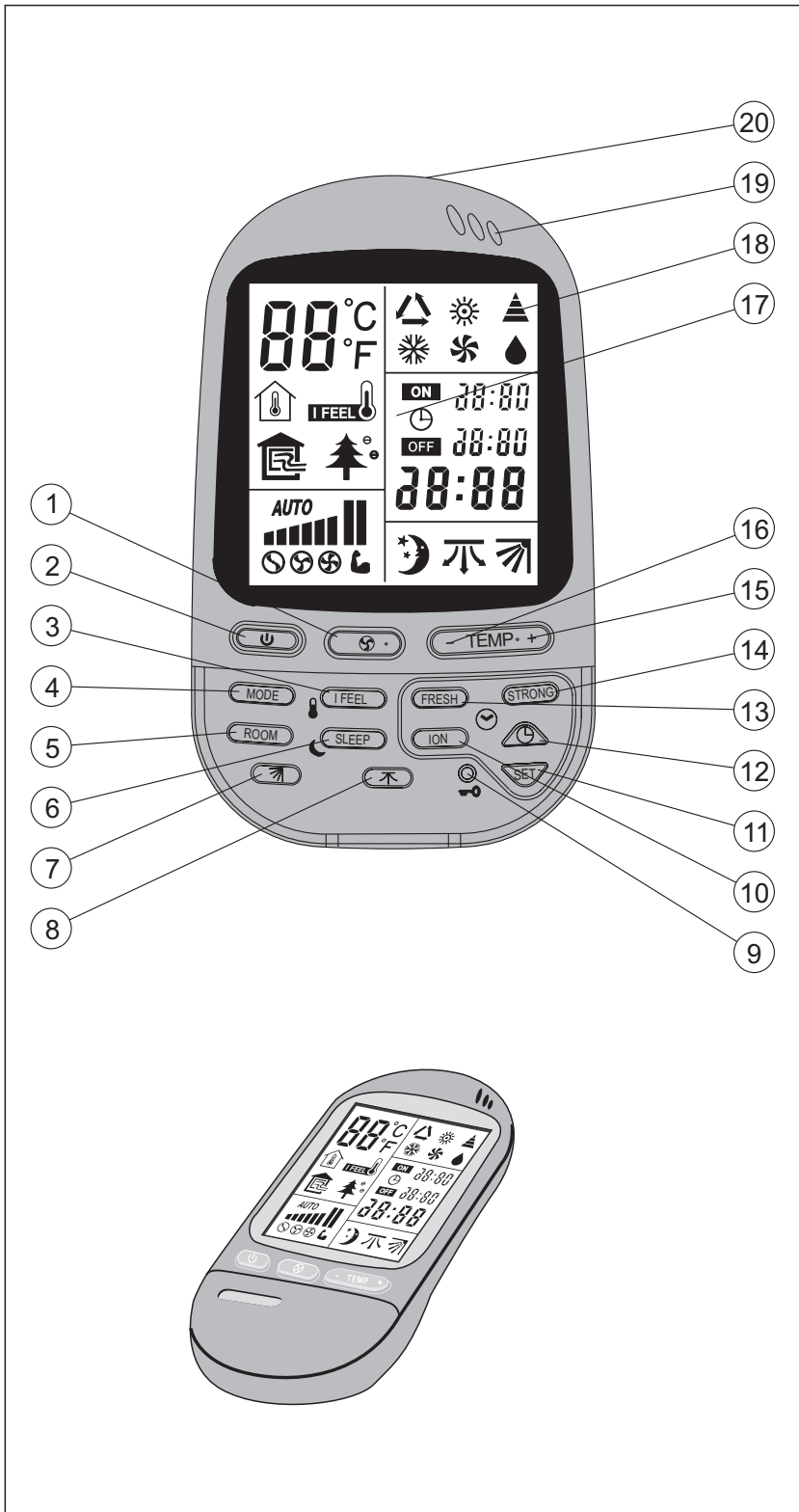

- 1 FAN SPEED and AUTO FAN button
- 2 START/STOP button
- 3 I FEEL temperature sensing mode button
- 4 Operation mode selection button
COOLING
HEATING
AUTO COOL/HEAT
DRY
FAN
- 5 ROOM temperature display button
- 6 SLEEP button
- 7 HORIZONTAL Airflow direction
AUTO-CONTROL button
- 8 Airflow direction AUTO-CONTROL button
- 9 LOCK button
- 10 IONIZER button
- 11 TIMER SET button
- 12 TIMER button
- 13 FRESH AIR button
- 14 STRONG button
- 15 Room temperature Up button
- 16 Room temperature DOWN button
- 17 LCD operation display
- 18 Transmission sign
- 19 I FEEL sensor
- 20 Infrared signal transmitter

Note: Open the cover to reach the control buttons.

OPERATION PROCEDURE

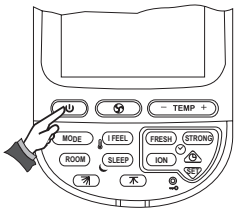

TURNING ON THE AIR CONDITIONER

Press START/STOP button (2) to turn on the air conditioner on. Indicator (A) on the air conditioner will light up, indicating that the unit is in operation. Note that the LCD operation display (17) will always show the last mode of operation and previous function used.

Follow the instructions if you choose to change the control settings; otherwise, the air conditioner will start and operate in the same mode and functions prior to being turned off.

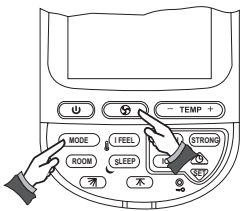

VENTILATING OPERATION

Select the ventilating mode by pressing MODE button (4). Switch to the desired fan speed by pressing FAN speed button (1).

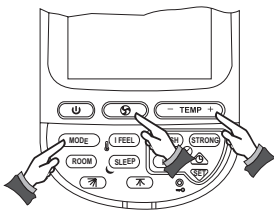

COOLING OPERATION

Select the COOLING mode by pressing MODE button (2). Switch to the desired FAN SPEED or to AUTO FAN by pressing button (4). Select suitable temperature setting. By selecting the COOLING mode, the air flap will move automatically to horizontal air delivery position, optimal for cooling.

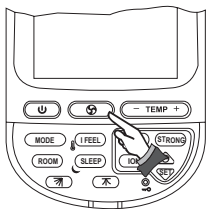

COOLING OPERATION WITH AUTO FAN MODE

This operation starts with the highest air flow in order to quickly lower the room temperature. It will then automatically switch to the low air flow to quietly maintain the selected temperature.

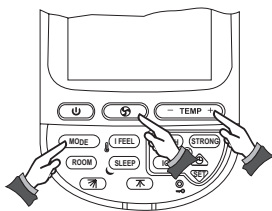

HEATING OPERATION

Select the HEATING mode by pressing MODE button (2). Switch to the desired FAN SPEED or to AUTO FAN by pressing FAN button (4). Select suitable temperature setting. By selecting the HEATING mode, the air flap will move automatically to vertical air delivery position, optimal for heating. The HOT KEEP function is provided. The fan will be turned off when the indoor coil temperature is not sufficiently hot to prevent uncomfortable cold air drafts. In some models the HOT KEEP function is operating in AUTO FAN mode only.

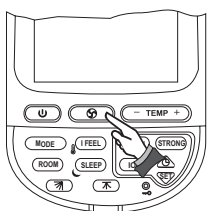

HEATING OPERATION WITH AUTO FAN MODE

This operation starts with the highest air flow in order to quickly raise the room temperature. It will then automatically switch to a lower air flow to quietly maintain the selected temperature.

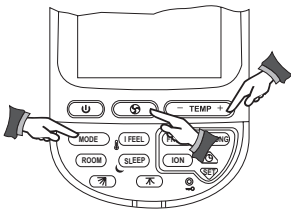

AUTO COOLING/HEATING OPERATION

Select the AUTO mode by pressing MODE button (4). Switch to the desired FAN SPEED or to AUTO FAN by pressing button (1). Select suitable temperature setting. The air flap will automatically move to either horizontal air delivery for cooling or to vertical air delivery for heating. At start, the air conditioner will select its mode of operation according to the room temperature and the temperature setting.

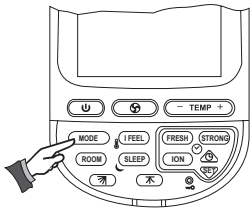

DRY OPERATION

Select the DRY mode by pressing MODE button (2). Select the suitable temperature setting. While in DRY mode, the air conditioner will operate at low fan speed, regardless of the fan setting on the LCD operation display. Fan might terminate operation from time to time to prevent from over cooling. By selecting the mode, the air flap will move automatically to optimal horizontal air delivery position.

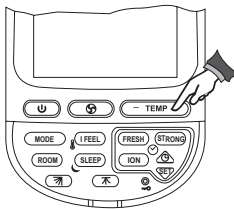

SELECTING THE TEMPERATURE

Press TEMP button (15) or (16) to change the temperature setting in the LCD operation display (17). The temperature setting is shown in degrees centigrade. A higher number indicates a higher room temperature. A lower number indicates a lower room temperature.

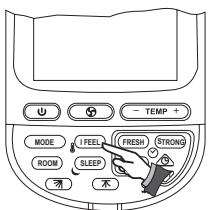

I FEEL FUNCTION

Press I FEEL button (3) to activate the I FEEL function. Thermometer sign will appear on the LCD operation display (17). Select suitable temperature setting. Make sure that the remote control unit is aimed at the air conditioner, with the I FEEL sensor (19) in front. Prevent the I FEEL sensor from being affected by heat sources such as lamps, heaters, direct sun, etc. or from being directly affected by the air conditioner air flow. These may cause the sensor to transmit the wrong temperature data, thereby disturbing the performance of the I FEEL function.

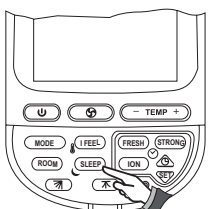

SLEEP FUNCTION

Press the SLEEP button (7) to select the SLEEP function.

The sleep icon light while sleep OFF time icon and the time which is 7 hours after current time blink as default. The default setting can be changed from 3 hr. To 12 hr. By pressing up and down buttons HOUR+(11) and HOUR-(12) respectively. (The sleep timer will display the default time or the setting time plus the current time initially in the display.

For example: current time is 23:00 and the sleep mode is set, the sleep mode OFF time will be 6:00. If the sleep of time is set to 10 hr, then the sleep mode OFF time will be 9:00. All other timers will temporarily be suspended during the activation of the sleep timer.

To cancel the SLEEP function press on one of the following:

- START/STOP button (1)
- SLEEP button (7)

NOTE: In some models the SLEEP icon lights only and the OFF time is set for seven hours as default.

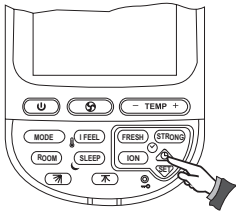

TIMER OPERATION

Press TIMER select button (12) to activate the timed operation mode. Each time you press TIMER button (12), one of the following four operation modes will appear on the LCD display. The operation modes are sequenced in turn in the direction of arrow. During Timer operation, the indicator on the air conditioner will light up.

Note: After the power is off (when the air-conditioner is in Timer mode), the air conditioner will automatically switch to stand-by mode and the Timer operation will also be cancelled. To resume the Timer operation, please follow the above instructions.

TIMER OPERATING MODES

I. TIMER ON

This mode enables you to set a start time.

Press Timer button (12) till ON sign blinks.

Star time can be adjusted using up and down buttons (15) and (16) respectively. Press Set button (11) to activate the timer.

Example: Operation is restored at 10:30 a.m.

II. TIMER OFF

This mode enables you to set the stop time of operation. Press the Timer button (12) till the OFF sign blinks. Time can be adjusted using up and down buttons (15) and (16) respectively. Press Set button (11) to activate the timer.

Example: Operation stops at 12:00 p.m. (24:00 hours).

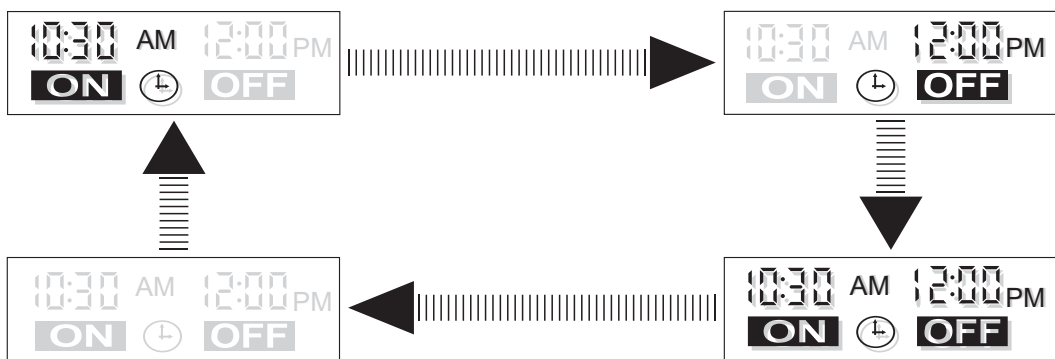

IV. CLEAR

Use this mode to cancel timer operation. Press TIMER button (12), timer operation will terminate and the LCD display will be cleared for each timer mode.

Note: If timer button (12) is selected and neither time adjust, Set, or Clear buttons are not pressed within 15 seconds; the timer operation will be cancelled and the last setup will be displayed

III. TIMER ON/OFF

This mode enables you to set the start and stop time of operation. Press Timer button (12) till the OFF sign blinks. By press again the ON sign blinks. Time can be adjusted by using the up and down buttons (15) and (16) respectively. Press Set button (11) to activate the timer.

Example: Operation is restored at 10:30 a.m. Operation stops at 12:00 p.m. (24:00 hours).

ROOM TEMPERATURE DISPLAY

By pressing on ROOM temperature, button (5), the measured room temperature and the room temperature sign will be displayed.

To cancel the ROOM Temperature display press on one of the following:

- Press again on ROOM temperature button (5).
- Change of MODE button (4)

Note: Room temperature range is between 0°C and 36°C in 1°C increments. Display should show "HI" or "LOW" to represent temperature that is above 36°C or below 2°C.

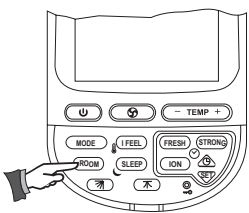

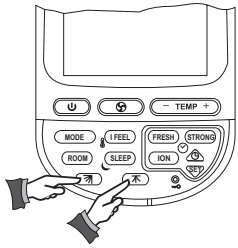

AIR DIRECTION OPERATION

1. Air Direction Positioning

Press button (8) to position the air flap to any desired angle.

2. Automatic Vertical Air Swing

Press button (7) to activate the auto air swing. Press button (7) to deactivate this function.

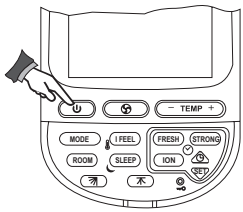

TURNING OFF THE AIR CONDITIONER

Press START/STOP button (2) to turn off the air conditioner. Indicator (A) on the air conditioner will be shifted from blue to red, indicating that the air conditioner is in STAND-BY mode and ready to accept any new command from the remote control. The remote control LCD will display the clock time. The last operating set-up will be kept for the next operation.

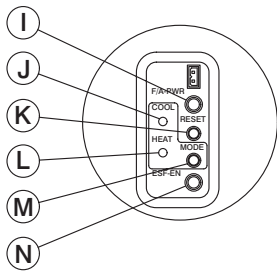

ON-UNIT OPERATION

If the air-conditioner cannot be operated by the Remote Control unit, it can be turned on for cooling or heating, or completely turned off, by pressing MODE button (M) on the air-conditioner. The MODE button will change the operating status of the unit between-COOLING-HEATING-STAND-BY positions, every time it is pressed. Indicators (J) (L) or (G) will light up respectively, to indicate in which mode the air-conditioner operates.

On units for Cooling only, do not set MODE switch on HEAT position.

CURRENT CLOCK TIME SET

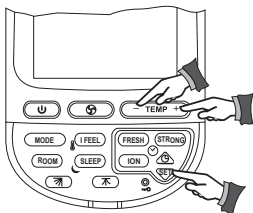

Clock setting is performed when batteries are inserted. The remote control displays the setting and the clock display will blink " 0:00 " or " 12:00 " AM (AM sign will blink, too) till a new time is set.

For clock setting, use buttons (15) and (16) for setting the hours and minutes, respectively, and then press timer SET button (11). The clock setting can be also performed by pressing time Set button (11) for 5 seconds.

The clock display will blink, for new setting follow the steps described above.

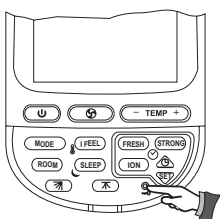

LOCK FUNCTION

By pressing LOCK button (9), the remote control will lock the last operation program. All the function buttons will be inoperative, including START/STOP button. By pressing LOCK button (9) again the remote control will be released from its locked position. When lock mode is functioning, the transmission sign (18) will be on.

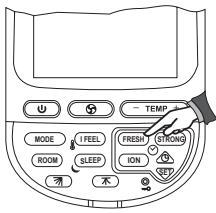

FRESH AIR FNCTION (optional)

PRESS THE FRESH AIR button (13) to activate the Fresh air function and press the button again to cancel this function.

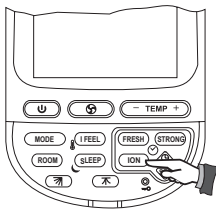

IONIZER AND ELECTROSTATIC FILTER

Press the IONIZER button (10) to activate the Ionizer and Electrostatic Filter function , if the Ionizer switch at ON position, the blue indicator on the Ionizer lights up. Press the button again,you will cancel the function.

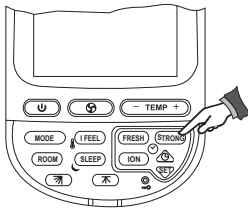

STRONG FUNCTION

Press the STRONG button (14) to activate strong function, the fan would run at the highest speed. And the fan speed could not change. Press the button again you will cancel this functin.

PROTECTION MODES

Your air-conditioner includes several auto protection modes which enables you to use it virtually at any time and in any season regardless of the outdoor temperature. Some of the protection modes are listed below:

Mode	Operation conditions	Protection from	Controlled remedy
Cooling and Dry	Low outdoor temperature	Indoor coil freezes up	Stops compressor when approaching freezing conditions Resumes operation automatically. Operating indicator(A) shifts to red.
	High outdoor temperature	Outdoor coil overheating	Stop compressor when approaching over heating conditions. Resumes operation automatically. Operating indicator (A) shifts to red.
Heating	Low outdoor temperature	Outdoor coil ice build up	Reverses operation from heating to cooling for short periods to de-ice outdoorcoil. Operating indicator (A) shifts to red.
	High Indoor or outdoor temperature	Indoor coil overheating	Stops compressor when approaching high indoor coil temperature. Resumes operation automatically. Operating indicator (A) shifts to red.

CARE AND MAINTENANCE

Before performing any maintenance procedure, make sure to disconnect the air conditioner from the power.

CLEANING THE AIR FILTER

- Your air conditioner is provided with a filter cleaning indicator. When the indicator (E) lights up, the filters should be removed for cleaning
- To remove the air filters, lift up the panel, push the air filters up slightly to unlock them, pull out the filters, Clean the filter by washing in warm soapy water and dry thoroughly, align and fit the filters in place, close the panel by pushing it in the center to lock it in place.
- Reset button (K) to turn off indicator (E).

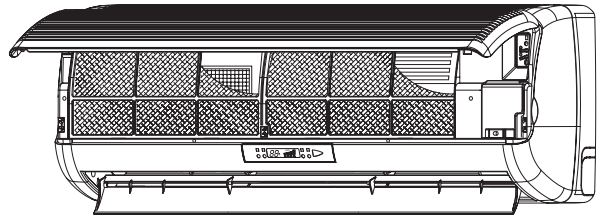

CLEANING THE ELECTROSTATIC FILTER

The electrostatic filter should be removed from the unit and cleaned once three month. The procedure is shown as following;

- 1 open the front panel
- 2 push the hook on the filter and pull out the electrostatic filter (Fig ①)
- 3 wash the filter with the warm soapy water and dry thoroughly
- 4 push the electrostatic filter into the right position
- 5 close the front panel

Note: the above procedure is used for cleaning the electrostatic filter.

Note: The above procedure is used for replacing the active carbon filter (when supplied).

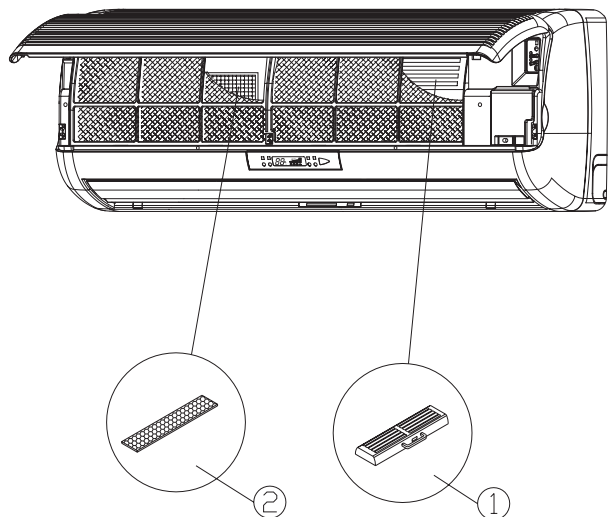

PURIFICATION FILTER REPLACEMENT

● The air purifying filter should be removed from the unit and replaced once a year, show as following:

- 1 pulling out the filter (Fig ②)
- 2 replacing the filter in its place

DO NOT OPERATE THE UNIT WITHOUT FILTERS!

CLEANING THE AIR CONDITIONER

- Wipe the unit with a soft dry cloth or clean it using a vacuum cleaner
- do not hot water or volatile materials which could damage The surface of the air conditioner.

AT THE BEGINNING OF THE SEASON

- Make sure there are no obstacles blocking the flow of inlet or outlet air, in both indoor and outdoor units.
- Make sure the power is properly connected.

PROTECT THE ELECTRONIC SYSTEM

- Indoor unit and remote control must be at least 1 meter away from a TV, radio or any other home electronic appliance.
- Protect the inner unit from direct sun or lighting.

REMOTE CONTROL BATTERY CHANGE

- Remove the batteries from the remote control as shown.
- Use two 1.5 volt size AAA batteries.

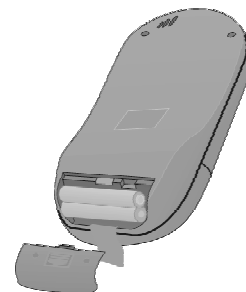

OPERATING TIPS

- Set a suitable room temperature; excessively low room temperature is not good for your health and wastes electricity. Avoid frequent setting of the temperature.
- During cooling, avoid direct sun. Keep curtains and blinds closed. Close doors and windows to keep the cool air in the room.
- Avoid generating heat or using of heating appliances while the air conditioner is in cooling mode.
- Make sure that the air flap is positioned properly: horizontal flow in cooling and downward vertical flow for heating.
- Keep the room temperature uniform by adjusting the Left/Right vertical air blades.
- Position the air flap and the left/right air blades in such a manner as to prevent your body from being exposed directly to air drafts.
- During prolonged operation, ventilate the room occasionally by opening a window from time to time.
- In a power failure, the microprocessor memory is retained. When restarted, operation will be resumed in the last mode of operation. However, if the timer was used, the unit will be turned off by the timer only if the remote control is aimed at the unit. Otherwise the power failure will cause the timer data to be erased from the microprocessor memory.
- After turning on, allow more than 3 minutes for cooling, heating or dry operation to start.
- When Dry mode is used, make sure that the room temperature is between 20° to 27°C. When used out of this range, the unit may protect itself and become inoperative.
- When COOL or DRY modes are used, make sure that the room's relative humidity is below 78%. If the unit is used for a prolonged periods of time in high humidity, moisture may form on the air outlet and drip down.
- Remote control signals may not be received if the indoor unit controls cover is exposed to direct sunlight or strong light. In such a case, block the sunlight or dim the lighting.
- The remote control is operative in a range of 8 meters. If you are out of range, the remote control may have difficulties in transmitting signals.

PRECAUTIONS

- Use the proper electrical fuse..
Do not pull out the power cord unless the unit is turned off.

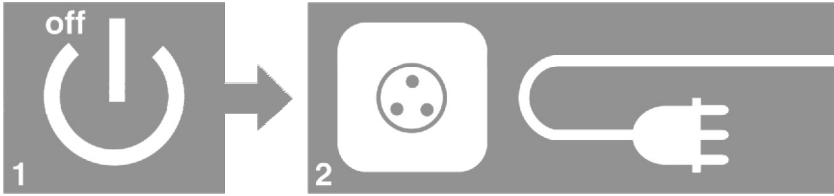

- Do not turn on or off air conditioner by inserting the power cord.

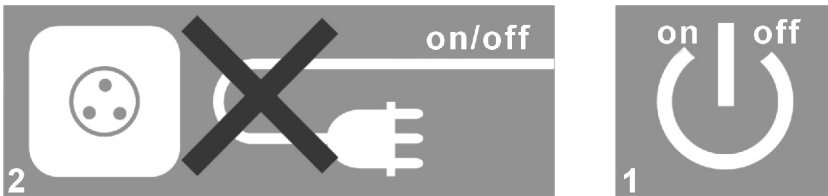

- Do not obstruct or block the air inlet or air outlet of the air conditioner.

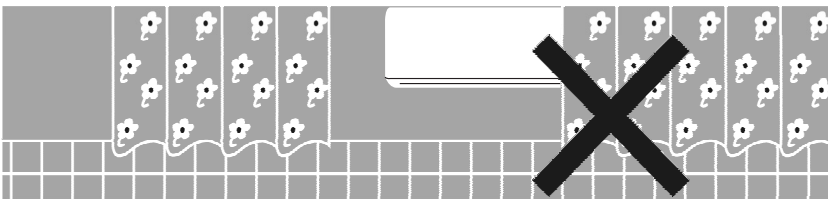

- Do not insert any objects in the air outlet of the indoor or outdoor units.



- Do not splash water on air conditioner.

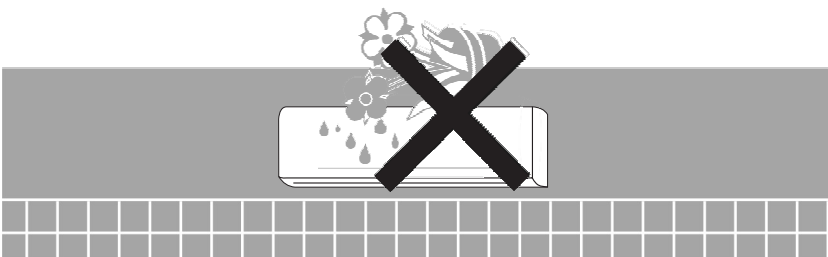

IF NOISE IS HEARD

There may be hissing sound during operation or just aftershut down. This is caused by the refrigerant that is circulating inside the unit

There may be a cracking sound at starting and stopping the unit's operation. This is caused by heat expansion or contraction of plastics.

BEFORE CALLING FOR SERVICE

Before calling for service, please check the following common malfunctions and correct it as needed.

Problem	Cause	Remedy
<ul style="list-style-type: none"> • Unit does not operate. Standby indicator does not light up. 	<ul style="list-style-type: none"> <input type="checkbox"/> Unit not connected to power <input type="checkbox"/> Power failure 	<ul style="list-style-type: none"> ■ Plug in the power cord. ■ Check main fuse.
<ul style="list-style-type: none"> • Unit does not operate. Standby indicator lights. 	<ul style="list-style-type: none"> <input type="checkbox"/> Remote control malfunctions <input type="checkbox"/> The remote control is locked. 	<ul style="list-style-type: none"> ■ Check remote control batteries. ■ Try to operate from a closer distance. ■ Start from on-unit controls. ■ Unlock the remote control.
<ul style="list-style-type: none"> • Unit does not respond properly to remote control command. 	<ul style="list-style-type: none"> <input type="checkbox"/> IR signal does not reach unit. <input type="checkbox"/> Distance between remote control and unit too large or aimed at from improper angle. <input type="checkbox"/> IR receiver on-unit exposed to strong light source. 	<ul style="list-style-type: none"> ■ Check for obstruction between unit and remote control, Clear if needed. ■ Get closer to unit. ■ Dim lights, fluorescents especially
<ul style="list-style-type: none"> • Air does not blow out from indoor unit. 	<ul style="list-style-type: none"> <input type="checkbox"/> De-icing protection mode is activated. <input type="checkbox"/> Unit is in AUTO FAN mode. <input type="checkbox"/> Over cooling in DRY. 	<ul style="list-style-type: none"> ■ Normal operation in HEATING mode. ■ Normal operation in DRY mode.
<ul style="list-style-type: none"> • COOLING, DRY or HEATING does not start immediately. 	<ul style="list-style-type: none"> <input type="checkbox"/> 3-min. Compressor delayed start 	<ul style="list-style-type: none"> ■ Normal operation for these modes.
<ul style="list-style-type: none"> • Unit functions but does not perform sufficiently. 	<ul style="list-style-type: none"> <input type="checkbox"/> Improper temperature setting. <input type="checkbox"/> Unit capacity insufficient for load or room size. 	<ul style="list-style-type: none"> ■ Reset temperature. ■ Consult your dealer.
<ul style="list-style-type: none"> • Filter indicator lights up 	<ul style="list-style-type: none"> <input type="checkbox"/> Air filter needs cleaning. 	<ul style="list-style-type: none"> ■ Clean filter, reinstall and reset indicator

