

SAFETY PRECAUTIONS

Read the following "SAFETY PRECAUTIONS" carefully before installation.

Electrical work must be installed by a licensed electrician. Be sure to Use the correct rating of the power plug and main circuit for the model to be installed.

- The caution items stated here must be followed because these important contents are related to safety. The meaning of each indication used is as below. Incorrect installation due to ignoring of the instruction will cause harm or damage, and the seriousness is classified by the following indications.

WARNING This indication shows the possibility of causing death or serious injury.

The items to be followed are classified by the symbols:

Symbol with background white denotes item that is PROHIBITED from doing.

- Carry out test running to confirm that no abnormality occurs after the installation. Then, explain to user the operation, care and maintenance as stated in instructions. Please remind the customer to keep the operating instructions for future reference.

WARNING

- Use qualified installer and follow careful this instructions. Otherwise it will cause electrical shock, water leakage, or esthetic problem.
- Install at a strong and firm location which is able to withstand the set's weight. If the strength is not enough or installation is not properly done, the set will drop and cause injury.
- For electrical work, follow the local national wiring standard, regulation and this installation instruction. An independent circuit and single outlet must be used. If electrical circuit capacity is not enough or defect found in electrical work, it will cause electrical shock or fire.
- Use the specified cable and connect tightly for indoor/outdoor connection. Connect tightly and clamp the cable so that no external force will be acted on the terminal. If connection or fixing is not perfect, it will cause heat-up or fire at the connection.
- Wire routing must be properly arranged so that control board cover is fixed properly. If control board cover is not fixed perfectly, it will cause heat-up at connection point of terminal, fire or electrical shock.
- When carrying out piping connection, take care not to let air substances other than the specified refrigerant go into refrigeration cycle. Otherwise, it will cause lower capacity, abnormal high pressure in the refrigeration cycle, explosion and injury.
- Do not damage or use unspecified power supply cord. Otherwise, it will cause fire or electrical shock.
- Do not modify the length of the power supply cord or use of the extension cord, and do not share the single outlet with other electrical appliances. Otherwise, it will cause fire or electrical shock.
- This equipment must be earthed. It may cause electrical shock if grounding is not perfect.
- Do not install the unit at place where leakage of flammable gas may occur. In case gas leaks and accumulates at surrounding of the unit, it may cause fire.
- Carry out drainage piping as mentioned in installation instructions. If drainage is not perfect, water may enter the room and damage the furniture.
- For appliances with supplementary heaters, the minimum clearance from the appliance to combustible is 50cm other wise, it will cause fire.

ATTENTION

- Selection of the installation location. Select a installation location which is rigid and strong enough to support or hold the unit, also for easy maintenance and repair.
- Power supply connection to the room air conditioner. Connect the power supply cord of the room air conditioner to the mains using one of the following method. Power supply point shall be the place where there is ease for access for the power disconnection in case of emergency. In some countries, permanent connection of this room air conditioner to the power supply is prohibited.
 - Power supply connection to the receptacle using a power plug. Use an approved 10A power plug with earth pin for 2.1-3.6kW and 15A for 4.0kW for the connection to the receptacle.
 - Power supply connection to a circuit breaker for the permanent connection. Use an approved 10A circuit breaker for 2.1-3.6kW and 15A for 4.0kW for the permanent connection. It must be a double pole switch with a minimum 3mm contact gap.
- Do not release refrigerant. Do not release refrigerant during piping work for installation, reinstallation and during repairing a refrigeration parts. Take care of the liquid refrigerant. It may cause frostbite.
- Installation work. It may need two people to carry out the installation work.
- Do not install this appliance in a laundry room or other location where water may drip from the ceiling, etc.

Required tools for Installation Works

- Screw driver
- Electric drill, hole core drill
- Hexagonal wrench
- Spanner
- Pipe cutter
- Reamer
- Knife
- Gas leak detector
- Measuring tape
- Thermometer
- Megameter
- Multimeter
- Torque wrench 18/35/55Nm (1.8/3.5/5.5 kgf.m)
- Vacuum pump
- Gauge manifold (for R-410A)

INSTALLATION/SERVICE TOOLS (ONLY FOR R410A PRODUCT)

CAUTION

New Refrigerant Air Conditioner Installation

THIS AIR CONDITIONER ADOPTS THE NEW HFC REFRIGERANT (R410A) WHICH DOES NOT DESTROY OZONE LAYER. R410A refrigerant is apt to be affected by impurities such as water, oxidizing membrane, and oils because the working pressure of R410A refrigerant is approx. 1.6 times of refrigerant R22. Accompanied with the adoption of the new refrigerant, the refrigeration machine oil has also been changed. Therefore, during installation work, be sure that water, dust, former refrigerant, or refrigeration machine oil does not enter into the new type refrigerant R410A air conditioner circuit. To prevent mixing of refrigerant or refrigerating machine oil, the sizes of connecting sections of charging port on main unit and installation tools are different from those used for the conventional refrigerant units. Accordingly, special tools are required for the new refrigerant (R410A) units. For connecting pipes, use new and clean piping materials with high pressure fittings made for R410A only, so that water and/or dust does not enter. Moreover, do not use the existing piping because there are some problems with pressure fittings and possible impurities in existing piping.

Changes in the product and components

In air conditioners using R410A, in order to prevent any other refrigerant from being accidentally charged, the service port diameter size of the outdoor unit control valve (3 way valve) has been changed. (1/2 UNF 20 threads per inch)
 ● In order to increase the pressure resisting strength of the refrigerant piping, flare processing diameter and opposing flare nuts sizes have been changed. (for copper pipes with nominal dimensions 1/2 and 5/8)

New tools for R410A

| New tools for R410A | Applicable to R22 model | Changes |
|---|-------------------------|---|
| Gauge manifold | X | As the working pressure is high, it is impossible to measure the working pressure using conventional gauges. In order to prevent any other refrigerant from being charged, the port diameters have been changed. |
| Charge hose | X | In order to increase pressure resisting strength, hose materials and port sizes have been changed (to 1/2 UNF 20 threads per inch). When purchasing a charge hose, be sure to confirm the port size. |
| Electronic balance for refrigerant charging | O | As working pressure is high and gasification speed is fast, it is difficult to read the indicated value by means of charging cylinder, as air bubbles occur. |
| Torque wrench (nominal dia. 1/2, 5/8) | X | The size of opposing flare nuts have been increased. Incidentally, a common wrench is used for nominal diameters 1/4 and 3/8. |
| Flare tool (clutch type) | O | By increasing the clamp bar's receiving hole size, strength of spring in the tool has been improved. |
| Gauge for projection adjustment | - | Used when flare is made by using conventional flare tool. |
| Vacuum pump adapter | O | Connected to conventional vacuum pump. It is necessary to use an adapter to prevent vacuum pump oil from flowing back into the charge hose. The charge hose connecting part has two ports - one for conventional refrigerant (7/16 UNF 20 threads per inch) and one for R410A. If the vacuum pump oil (mineral) mixes with R410A a sludge may occur and damage the equipment. |
| Gas leakage detector | X | Exclusive for HFC refrigerant. |

- Incidentally, the "refrigerant cylinder" comes with the refrigerant designation (R410A) and protector coating in the U.S.'s ARI specified rose color (ARI color code: PMS 507).
- Also, the "charge port and packing for refrigerant cylinder" requires 1/2 UNF 20 threads per inch corresponding to the charge hose's port size.

Indoor/Outdoor Unit Installation Diagram

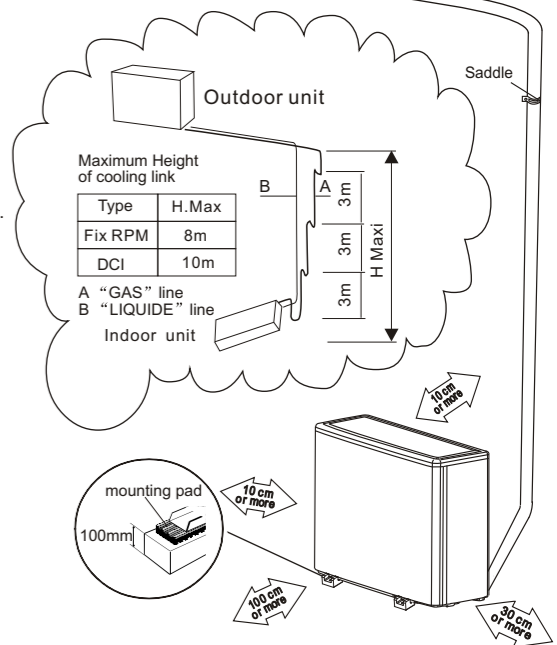
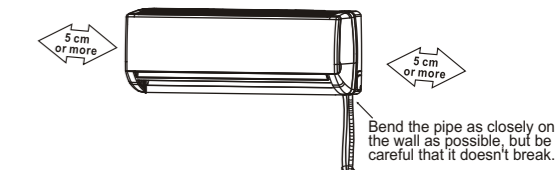
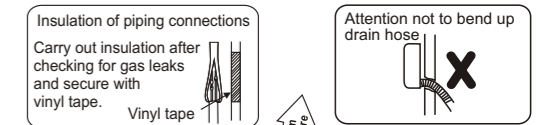
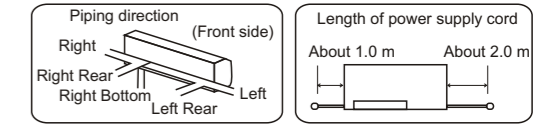

Attached accessories.

Below figures only for reference, the actual appearance may differ:

| No. | Accessories part | Qty. | No. | Accessories part | Qty. |
|-----|-----------------------------------|------|-----|--------------------------------------|------|
| 1 | Installation plate | 1 | 8 | Cable ties | 4 |
| 2 | Remote control with batteries | 1 | 9 | Power input cable (Optional) | 1 |
| 3 | Remote control bracket (optional) | 1 | 10 | Air purifying filter (optional) | 2 |
| 4 | Screws dowels | 6or4 | 11 | Installation carton board (optional) | 1 |
| 5 | Mounting pads(optional) | 1 | 12 | Unit support(optional) | 2 |
| 6 | Outdoor unit drain connector | 1 | 13 | Manual package | 1 |
| 7 | Cable terminal | 1 | 14 | Twin-wire cable(optional) | 1 |

SELECT THE BEST LOCATION

INDOOR UNIT

- There should not be any heat source or steam near the unit.
- There should not be any obstacles blocking the air circulation.
- A place where air circulation in the room is good.
- A place where drainage can be easily done.
- A place where noise prevention is taken into consideration.
- Do not install the unit near the door way.
- Ensure the spaces indicated by arrows from the wall, ceiling, fence or other obstacles.
- Recommended installation height for indoor unit shall be at least 2.3m.

OUTDOOR UNIT

- If an awning is built over the unit to prevent direct sunlight or rain, be careful that heat radiation from the condenser is not obstructed.
- There should not be any animal or plant which could be affected by hot air discharged.
- Keep the spaces indicated by arrows from wall, ceiling, fence or other obstacles.
- Do not place any obstacles which may cause a short circuit of the discharged air.
- If piping length is over 10m, additional refrigerant should be added as shown in the outdoor unit table.

1 SELECT THE BEST LOCATION (Refer to "Select the best location" section)

2 FIX INSTALLATION PLATE AND PENETRATE WALL FOR TUBING

The mounting wall is strong and solid enough to prevent it from the vibration. Mounting template for indoor unit installation:

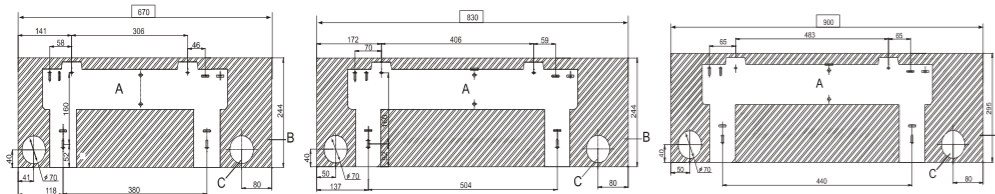

A: Installation plate B: Indoor unit (Carton board) outline C: Tubing wall opening

If supplying the installation carton board, pls follow below instructions:

- conglutinate the installation carton board on the wall in a horizontal position.
- drill four holes as shown to accommodate the dowels.
- drill the piping holes as shown slightly slanted a 5 down-ward angle to the outdoor side.
- take away the carton board and mount the installation plate with screws.

Otherwise, pls follow below:

- locate the installation plate on the wall in a horizontal position.
- mark the position of the mounting holes as shown and drill holes to accommodate the dowels. Then mount the installation plate by screws.
- mark the location of the piping holes as shown. Then drill the holes slightly slanted a 5 down-ward angle to the outdoor side.

3 INDOOR UNIT INSTALLATION

FOR THE RIGHT/ RIGHT BOTTOM PIPING

- Cut the side / bottom notch of the corner cover
- Pull out the indoor piping
- Install the indoor unit
- Secure the indoor unit

FOR THE RIGHT REAR PIPING

- Pull out the indoor piping
- Install the indoor unit
- Secure the indoor unit

FOR LEFT PIPING

- Cut the side / bottom notch of the corner cover
- Install the indoor unit
- Secure the indoor unit

FOR LEFT REAR PIPING

- Install the indoor unit
- Secure the indoor unit

Pull out the piping and hose

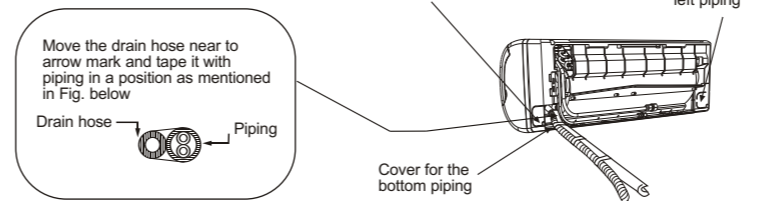

Install the Indoor Unit

- Hook the indoor unit onto the upper portion of installation plate (Engage the indoor unit with the upper edge of the installation plate). ensure the hooks are properly seated on the installation plate by moving in left and right.
- Used the installation support that assemble to the unit housing (or supply two installation supports in the accessory bag) to support the indoor unit in a angle about 25°, then connected the piping and Connecting cable
- Length of connecting cable.

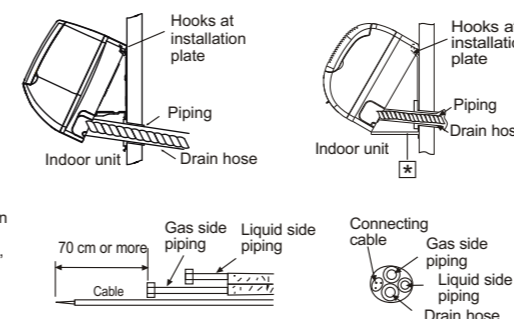

Secure the Indoor Unit

- Tape the extra connecting cable in a bundle and keep it behind the chassis.
 - Ensure that the connecting cable is not clamped in between the unit's hook (2 positions) and installation plate.
- Press the lower left and right side of the unit against the installation plate until hooks engages with their slots (sound click).

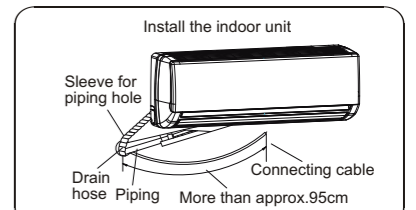
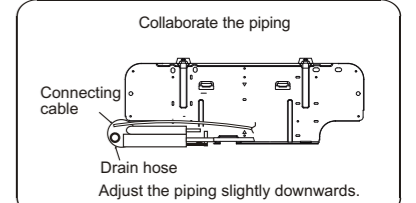
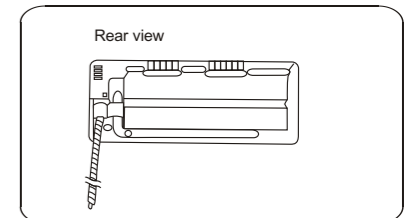
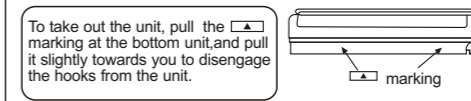
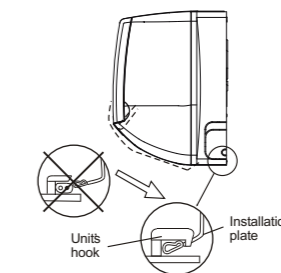

OUTDOOR UNIT

1 SELECT THE BEST LOCATION (Refer to "Select the best location" section)

2 INSTALL THE OUTDOOR UNIT

After selecting the best location, start installation according to Outdoor Unit Installation Diagram.

- Fix the unit on concrete or rigid frame firmly and horizontally by bolt nut (\varnothing 8 mm)

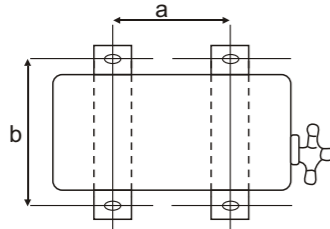

- When installing at roof, please consider strong wind and earthquake. Please fasten the installation stand firmly with bolt or nails.

| Dimension (mm) | Series (Based on the manufacture model on nameplate) | | | | | | |
|----------------|--|-----|-----|-----|---------------------|-------------------------|-------------------------|
| | ONG | GCN | GCZ | CON | GC (0-18000) Btu/hr | GC (18000-30000) Btu/hr | GC (30000-48000) Btu/hr |
| a | 500 | 472 | 472 | 403 | 472 | 543 | 527 |
| b | 308 | 237 | 237 | 248 | 237 | 330 | 378 |

Note: pls select the right installation date according to the model description on your unit nameplate.

3 CONNECTING THE PIPING

CUTTING AND FLARING THE PIPING

- Please cut using pipe cutter and then remove the burrs.
- Remove the burrs by using reamer. If burrs is not removed, gas leakage may be caused. Turn the piping end down to avoid the metal powder entering the pipe.
- Please make flare after inserting the flare nut onto the copper pipes.
- If you used the piping kit, you could connect the piping directness and no need do the procedure 1 to 3.

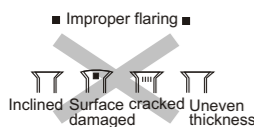
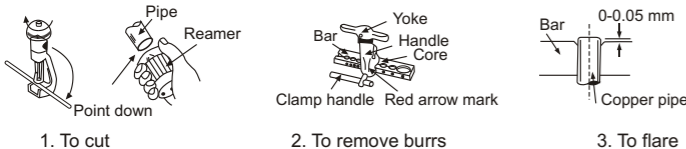

When properly flared, the internal surface of the flare will evenly shine and be of even thickness. since the flare part comes into contact with the connections, carefully check the flare finish.

Connecting The Piping To Indoor Unit

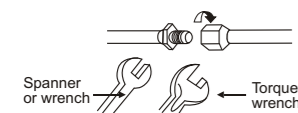

Connect the piping

- Align the center of piping and sufficiently Tighten the flare nut with fingers.
- Further tighten the flare nut with torque Wrench in specified Torque as stated in the table.

| Model | Refrigerant | Piping size | |
|----------------------|-------------|-----------------|-----------------|
| | | Gas | Liquid |
| (5000-12000) Btu/Hr | R22 & R407C | 3/8" (30-35N.m) | 1/4" (15-20N.m) |
| (12000-18000) Btu/Hr | R22 & R407C | 1/2" (50-54N.m) | 1/4" (15-20N.m) |
| (18000-31000) Btu/Hr | R22 & R407C | 5/8" (70-78N.m) | 3/8" (30-35N.m) |
| (31000-48000) Btu/Hr | R22 & R407C | 3/4" (80-88N.m) | 5/8" (70-78N.m) |
| (5000-12000) Btu/Hr | R410A | 3/8" (30-35N.m) | 1/4" (15-20N.m) |
| (12000-18000) Btu/Hr | R410A | 1/2" (50-54N.m) | 1/4" (15-20N.m) |
| (18000-31000) Btu/Hr | R410A | 5/8" (70-78N.m) | 3/8" (30-35N.m) |
| (31000-48000) Btu/Hr | R410A | 3/4" (80-88N.m) | 3/8" (30-35N.m) |

Connecting the Piping To Outdoor Unit

Align center of piping to valves and then tighten with torque wrench to the specified torque as stated in the table.

4 EVACUATION OF THE REFRIGERATION TUBES AND THE INDOOR UNIT

After connection the unions of the indoor and outdoor units, purge the air from the tubes and indoor unit as follows:

- Connect the charging hoses with a push pin to the low and high sides of the charging set and the service port of the suction and liquid valves. Be sure to connect the end of the charging hose with the push pin to the service port.
- Connect the center hose of the charging set to a vacuum pump.
- Turn on the power switch of the vacuum pump and make sure that the needle in the gauge moves from 0MPa (0cm Hg) to -0.1 MPa (-76cm Hg). Let the pump run for fifteen minutes.
- Close the valves of both the low and high sides of the charging set and turn off the vacuum pump. Note that the needle in the gauge should not move after approximately five minutes.
- Disconnect the charging hose from the vacuum pump and from the service ports of the suction and liquid valves.
- Tighten the service port caps from both valves.
- Remove the valve caps from both valves, and open them using a hexagonal Allen wrench.
- Remount valve caps onto both of the valves.
- Check for gas leaks from the four unions and from the valve caps. Test with electronic leak detector or with a sponge immersed in soapy water for bubbles.

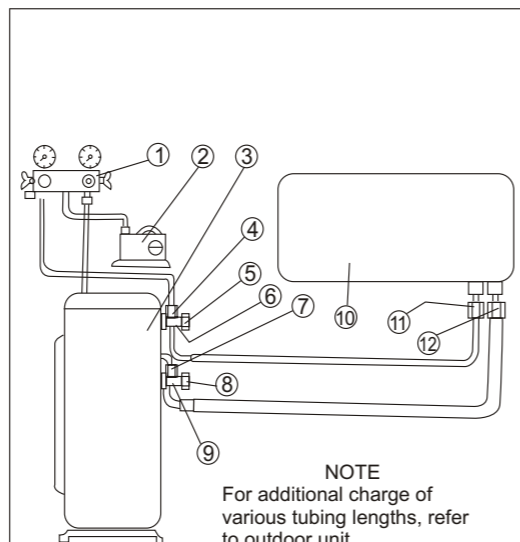

NOTE
For additional charge of various tubing lengths, refer to outdoor unit nameplate. refer to outdoor unit nameplate or performance table.

- Charging set
 - Vacuum pump
 - OUTDOOR UNIT
 - Service valve
 - Cap
 - Suction valve
 - Service valve*
 - Cap
 - Liquid valve
 - INDOOR UNIT
 - Suction flare connection
 - Liquid flare connection
- *In some models only

5 CONNECT THE CABLE TO THE INDOOR UNIT AND OUTDOOR UNIT

Easy Connection Kit(optional)

If you have the Easy Connection Kit, you can connect the cable with the connector that in the cable straight.

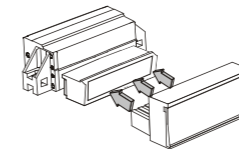

To connect the indoor unit to the outdoor unit use the following electrical cables, protected for outdoor use:

Electrical cable Wiring table:

| Capacity | (2000-3500) W | (3500-5000) W | (5000-8000) W |
|-----------------------|-------------------------------|-------------------------------|-------------------------------|
| Power Cord | 3 wires x 1.0 mm ² | 3 wires x 1.5 mm ² | 3 wires x 2.5 mm ² |
| Interconnecting Cable | 4 wires x 1.0 mm ² | 4 wires x 1.5 mm ² | 4 wires x 2.5 mm ² |

Interconnecting cable

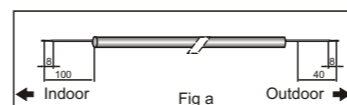

Low voltage cable (twin-wire)

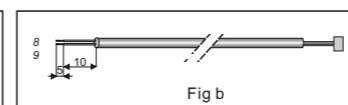

Electrical connection:

- Remove the control board cover from the unit by loosening the screws.
- Prepare the needed cables for electrical connection
- Connect the cable ends to the terminals of indoor and outdoor units as shown.

Wiring diagram

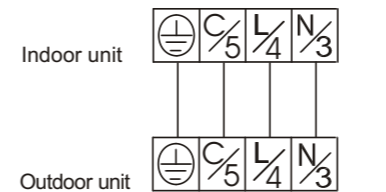

- Secure the multiple wire cable with the cable clamps.

Notes:

- The wire color code can be selected by the installer.
- For heating mode, wires leading to outdoor unit twin wire terminal must be in a separate wire cable as shown, otherwise, the electronic controls will be subjected to operational malfunctions. Fasten the twin wire cable to the multiple wire cable with cable ties after connecting.

6 PIPE INSULATION

- Please carry out insulation at pipe connection portion as mentioned in Indoor/ Outdoor Unit Installation Diagram. Please wrap the insulated piping end to prevent water from going inside the piping.
- If drain hose or connecting piping is in the room (where dew may form), please increase the insulation by using POLY-E FOAM with thickness 13 mm or above.

PURIFYING FILTER INSTALLATION (OPTIONAL)

- Open the grille.
- Remove the air filters.
- Put air purifying filter into place as shown in illustration.

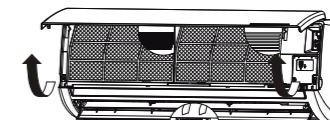
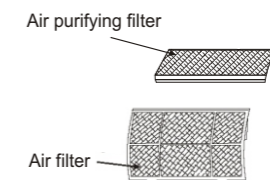

HOW TO TAKE OUT FRONT GRILLE

Please follow the steps below to take out front grille if necessary such as when servicing.

- Set the vertical airflow direction louver to the horizontal position.
- Slide down the three caps on the front grille as shown in the illustration at right, and then remove the three mounting screws.
- Pull the lower section of the front grille towards you to remove the front grille.

When reinstalling the front grille, first set the vertical airflow direction louver to the horizontal position and then carry out above steps 2-3 in the reverse order.

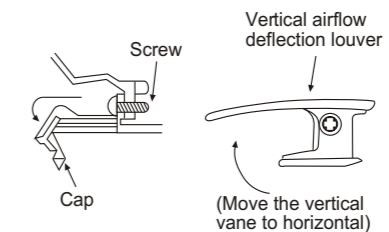

DISPOSAL OF OUTDOOR UNIT DRAIN WATER

If a drain elbow is used, the unit should be placed on a stand which is taller than 3 cm.

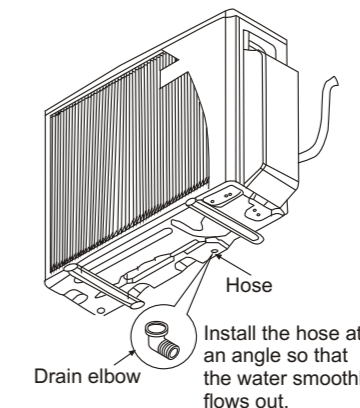

CHECK THE DRAINAGE

Open front panel and remove air filters. (Drainage checking can be carried out without removing the front grille.) Pour a glass of water into the drain tray-styrofoam. Ensure that water flows out from drain hose of the indoor unit.

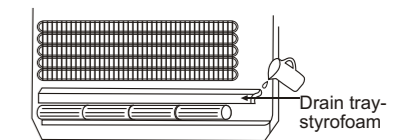

EVALUATION OF THE PERFORMANCE

Operate the unit at cooling operation mode for fifteen minutes or more. Measure the temperature of the intake and discharge air. Ensure the difference between the intake temperature and the discharge is more than 8°C.

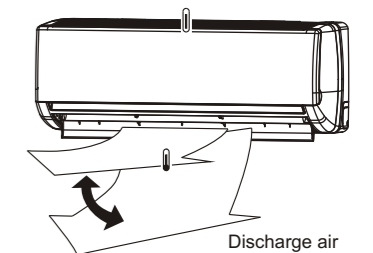

CHECK ITEMS

- Is there any gas leakage at flare nut connections?
- Has the heat insulation been carried out at flare nut connection?
- Is the connecting cable being fixed to terminal board firmly?
- Is the connecting cable being clamped firmly?
- Is the drainage ok? (Refer to "Check the drainage" section)
- Is the earth wire connection properly done?
- Is the indoor unit properly hooked to the installation plate?
- Is the power supply voltage complied with rated value?
- Is there any abnormal sound?
- Is the cooling operation normal?
- Is the thermostat operation normal?
- Is the remote control's LCD operation normal?

NOTE

This manual is for single split applications. For multi split applications please use installation manual supplied within outdoor unit package together.