

CLIMATISEUR SPLIT MURAL

FRANÇAIS

AIR CONDITIONER SPLIT WALL MOUNTED

ENGLISH

KLIMAGERÄT IN SPLIT BAUWEISE

DEUTSCH

CLIMATIZADOR SPLIT MURAL

ESPAÑOL

CONDIZIONATORE D'ARIA A PARETE SPLIT

ITALIANO

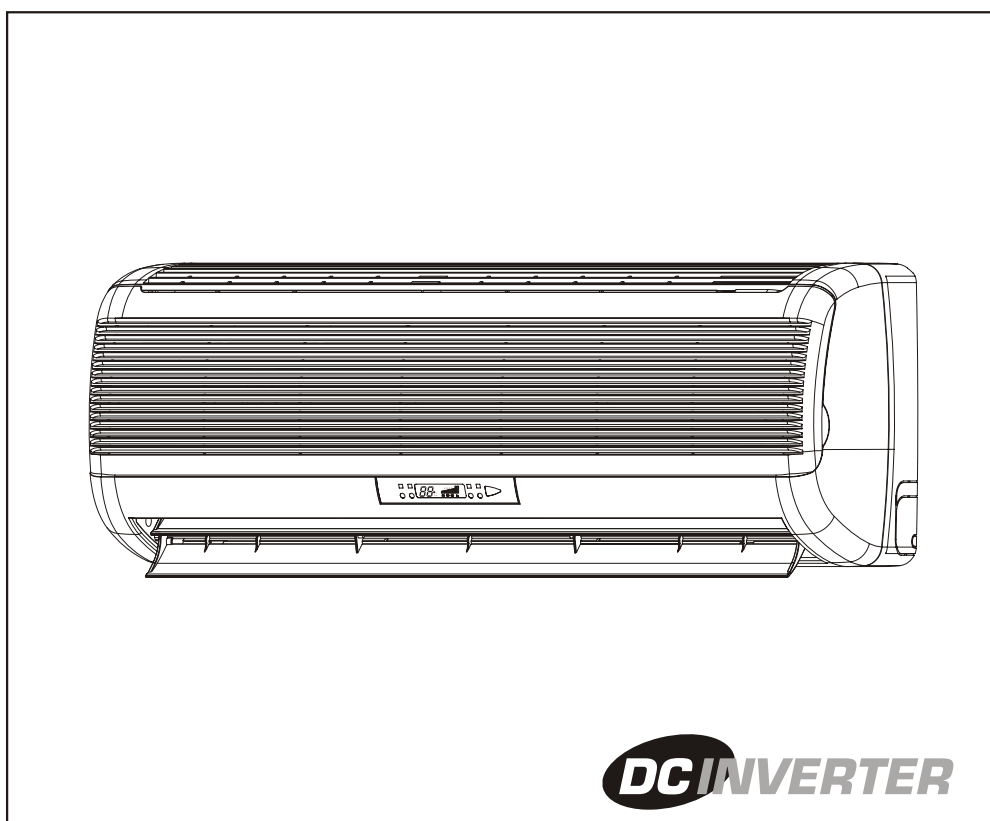

MANUEL D'UTILISATION ET DE PROGRAMMATION
PROGRAMMING AND OPERATING MANUAL
BEDIENUNGS UND PROGRAMMIERUNGS HANDBUCH
MANUAL DE UTILIZACIÓN Y DE PROGRAMMACION
MANUALE DI UTILIZZO E DI PROGRAMMAZIONE

Airwell

CONTENTS

INTRODUCTION	1
SYSTEM DESCRIPTION	2
MODES OF OPERATION, FUNCTIONS AND FEATURES	3
ON-UNIT INDICATORS AND CONTROLS	5
● On-unit Operation	5
PROTECTION MODES	6
CARE AND MAINTENANCE	7
OPERATING TIPS	8
PRECAUTIONS	9
BEFORE CALLING FOR SERVICE	10
EXCEPTION FOR MULTI SPLIT TYPE	11

*PLEASE READ THESE
INSTRUCTIONS **BEFORE**
OPERATING THE AIR
CONDITIONER*





INTRODUCTION

Dear customer:

The DC Inverter air conditioner you have purchased is one of the most advanced units of its kind. The DC Inverter air conditioner is a variable capacity air conditioner which uses high efficiency DC motors for the compressor and the outdoor fan. Unlike other models, it can adjust its capacity according to the user setting and the environmental condition, thus saving up to 30% of the seasonal power consumption, while keeping maximum comfort level. This modern unit is also equipped with an ionizer (optional) and an Electrostatic filter (optional) to maximize your indoor air quality.

Detailed instruction as to the DC Inverter air conditioner (including Single & Multi Split type) functions and way of operation are provided in the following pages.

This Split Air Conditioner is designed for versatile application:

	● Cooling.
	● Dehumidifying.
	● Heating.
	● Auto
	● Ventilation

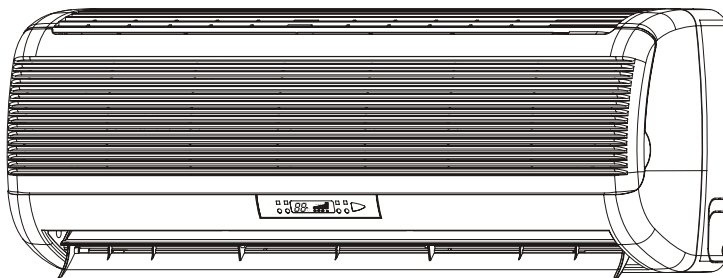

OPERATING TEMPERATURE RANGE:

-15°C ~ 46°C

IMPORTANT NOTICE:

- This air conditioner must be grounded to protect against electrical shock.
- Installation of the air conditioner must be performed by an experienced air conditioning installer, observing good refrigeration practice.
- Electrical connections and power cord replacement should only be made by authorized electricians and in accordance with electrical regulations and local codes. The appliance must be positioned so that the plug is accessible.
- Failure to comply with the manufacturer's installation and operation instructions could affect the performance of the air conditioner and the validity of the warranty.

Test Mode

Test Mode is set only for performance testing purposes, and not for user operation. Test mode can be initiated by either one of the following conditions:

- 1) Operating the unit with the following remote control settings and temperature conditions:
Cool Mode, SPT=16°C and RAT=27±1°C,
OAT=35±1°C for 30 minutes;
Heat Mode, SPT=30°C and RAT=20±1°C,
OAT=7±1°C for 30 minutes.
- 2) Entering Diagnostics with Cool/SPT=16°C or Heat/SPT=30°C.



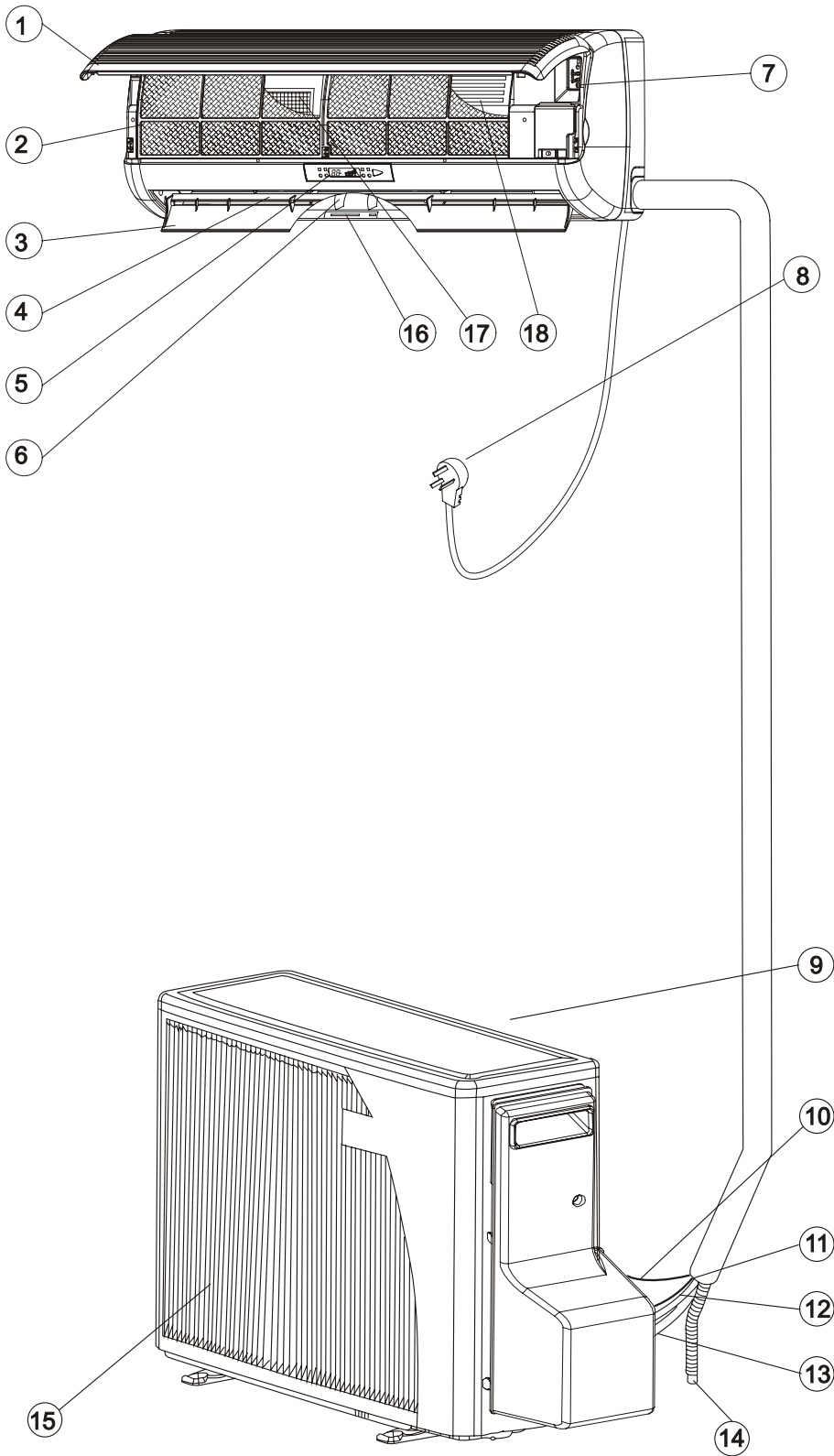





SYSTEM DESCRIPTION







- 1. Air intake grille
- 2. Air filter
- 3. Supply air flap (louver)
- 4. Air outlet
- 5. Unit's indicators
- 6. Horizontal Air flow Deflecting louvers
- 7. On unit operation
- 8. Power cord ※
- 9. Outdoor unit air intake
- 10. Power cable
- 11. Fresh-air controls wire (optional)
- 12. Liquid tube
- 13. Suction tube
- 14. Drain hose
- 15. Outdoor unit air outlet
- 16. Ionizer (optional)
- 17. Air purifying filter
- 18. Electrostatic filter (optional)

※ Not connected in multi split applications

MODES OF OPERATION, FUNCTIONS AND FEATURES

	COOL	Cools, dehumidifies and filters the room air. Maintains desired room temperature.
	HEAT	Heats and filters the room air. Maintains the desired room temperature.
	AUTO	Automatically select between cool and heat operation modes, according to the requested room temperature and the actual room conditions.
	DRY	Dehumidifies and softly cools the room In DRY Mode, the air conditioner operates at an increased dehumidifying power. This function is recommended to be used when temperature is rather low but the humidity is high.
	FAN	Recirculates and filters the room air. Maintains constant air movement in the room.
	AUTO FAN	The air conditioner automatically selects the FAN speed in accordance to the requested room temperature and the actual room temperature. During the first 30 minutes of unit operation after being turned ON, the unit operates at high fan speed to maximize the cooling/heating effect. As the room air approaches to the desired temperature, the fan switches to a lower speed for quieter operation.
	HOT KEEP	In HEATING, when unit is started, the indoor fan will not be turned on until the indoor coil reaches adequate temperature. This HOT KEEP feature prevents uncomfortable cold air drafts.
	I FEEL	Switches the temperature sensing point to the place where the remote control (optional) is located. (Generally the temperature sensor is located behind the intake grille of the air conditioner). This function is designed to provide a personalized environment by transmitting the temperature control command from the location next to you. The communication between the Remote Control and the unit is done by infra-red signal. Therefore, in using this function, the Remote Control should always be aimed, without obstructions, at the air conditioner.
	TIMER	Real time control and display, automatically turns the air conditioner ON and OFF according to the time of day setting, ensuring comfort conditions before returning home, without wasting electricity. It turns the air conditioner off automatically when sleeping.
	SLEEP	Designed to create comfortable sleeping conditions. When in COOLING mode, the temperature rises one degree centigrade after each consecutive hour, up to three hours, from the start of the mode. The temperature rise prevents the feeling of over-cooling while sleeping (when your body is at rest). In HEATING mode the reverse occurs; the air conditioner lowers its temperature one degree every hour, up to three hours, from the start of the mode. When in SLEEP mode, the air conditioner will be automatically turned off after have operated for seven hours. The result is a more comfortable and invigorating sleep, which leaves you feeling fresh and energetic in the morning.
	AUTO FLAP	The air flap (louvers) is automatically positioned for the most suitable blow-out angle, when COOL, HEAT, DRY or FAN modes are selected. When the air conditioner is turned off, the flap will close automatically for an aesthetic appearance.

	VERTICAL AIR SWING	Automatic swing of supply air in vertical direction. The flap moves automatically in upward and downward direction to spread the conditioned air evenly throughout the room.
	AIR DIRECTION POSITIONING	Automatic swing of Horizontal air flow in horizontal direction. The flap move automatically in right and left direction to spread the conditioned air evenly throughout the room.
	ROOM TEMPERATURE	Measures and displays room temperature.
	FILTER INDICATION	Filter indicator on the indoor unit display is turned on when the filter requires cleaning. After cleaning and reinstalling the filter, It should be reset.
	BUZZER	A soft buzzer will sound from the indoor unit display to indicate that a command sent by the remote control has been accepted and stored in the unit s memory. This feature may be easily cancelled by the user from the display panel.
	ON UNIT OPERATION	The air conditioner can be turned ON for COOLING or HEATING or be turned OFF directly by "MODE" key without the use of the remote control.
	3-MIN DELAYED RUN	The compressor is protected by a three-minute delayed restart.
	MEMORY	The microprocessor retains the last data entry whether or not the unit is plugged in. Therefore, when the unit restarts after a power failure, it will resume operating in the same mode as before the power was disrupted.
	LOCK	Freezes the last operation setting on the remote control. When LOCK is activated, the remote control will not be able to control the air-conditioner.
	ILLUMINATED KEYPAD AND LCD DISPLAY (optional)	By pressing any button in dark environment, the keypad and the LCD display will be illuminated.
	ELECTROSTATIC FILTER (optional)	They are capable of capturing small particles down to 0.1 microns, Such as atmospheric and house hold dust, coal dust, insecticide dust, mites, pollen, pet dander, tobacco smoke particles, cooking smoke and grease, mold fungi, bacteria, viruses and more.
	IONIZER (optional)	Ionizer makes the air more fresh and more comfortable. Slide switch (H) to the ON position to activate the ionizer. The blue light indicator (G) on the unit will light up indicating the ionizer in operation. To cancel the operation set slide switch to OFF position. Important Notice: When the air-conditioner is turned OFF or if the indoor fan stops operation, the IONIZER stops automatically.

ON-UNIT INDICATORS AND CONTROLS

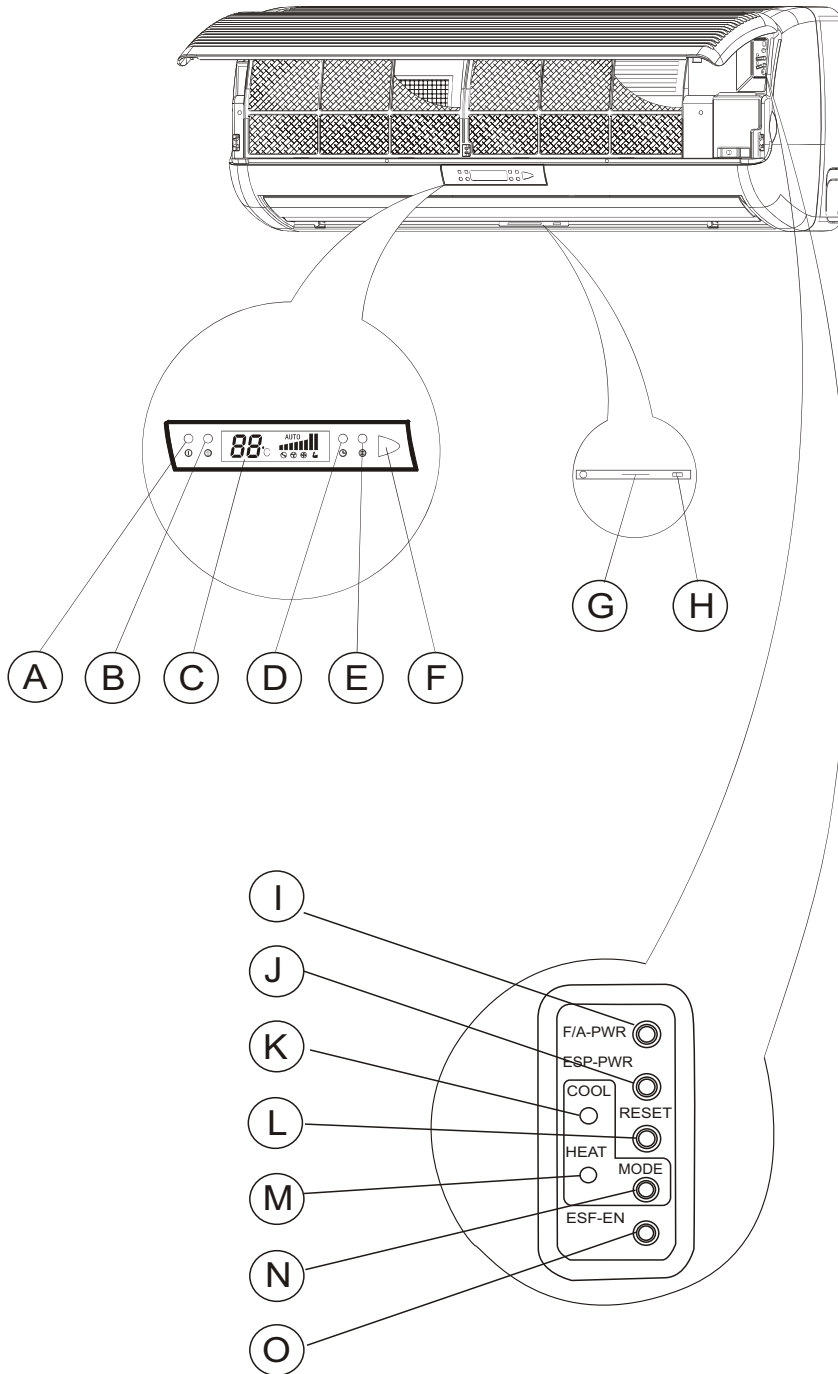

- A. Stand-by / Operation indicator
Lights up in red when connected to power.
Lights up in green during operation.
- B. ESF / Ionizer indicator
Lights up during the ESF or ionizer operation.(optional)
- C. LCD operation display
- D. Timer indicator
Lights up during timer and sleep operation.
- E. Filter indicator
Lights up when air filter requires cleaning.
- F. Signal receiver
Receive signals from the remote control.
- G. Ionizer indicator
Lights up during ionizer operation .
- H. Ionizer on/off switch
Used to switch the ionizer on/off.
- I. Fresh air on/off
- J. Electrostatic filter operation button.
Used to switch the Electrostatic filter on or off.
- K. Cooling indicator
Lights up only when Mode (N) is pressed.
- L. Reset button
 - Press to turn off the filter indicator and to reset the filter function, after the cleaned filter has been reinstalled.
 - Press to cancel the buzzer announcer.
- M. Heating indicator
Lights up only when Mode (N) is pressed.
- N. Unit mode button
Used to switch the unit off or to turn it on for cooling or heating without the remote control.
- O. Electrostatic filter safety button
Turn off the Electrostatic filter when you open the grille.

If the air-conditioner can not be operated by the Remote Control unit, it can be turned on for cooling or heating, or completely turned off, by pressing MODE button (N) on the air-conditioner. The MODE button will change the operating status of the unit between - COOLING - HEATING - STAND BY positions. Every time it is pressed, MODE button (N), (K) or (M) will light up respectively, to indicate in which mode the air-conditioner operates.

PROTECTION MODES

Your air conditioner includes several automatic protection modes which enables you to use it virtually at any time and in any season, regardless of the outdoor temperature. Some of the protection modes are listed below:

Mode	Operation conditions	Protection from	Controlled remedy
Cooling	Low outdoor temperature	Indoor coil Freezes up	Stops outdoor fan and compressor when approaching freezing conditions Resumes operation automatically Operating indicator (A) blinks.
	High outdoor temperature	Outdoor coil overheating	Stops compressor when approaching over heating conditions. Resumes operation automatically. Operating indicator (A) blinks.
Heating	Low outdoor temperature	Outdoor coil ice build up	Reverses operation from heating to cooling for short periods to de-ice outdoor coil. Operating indicator (A) blinks.
	High Indoor or outdoor temperature	Indoor coil overheating	Stops outdoor fan and compressor when approaching high indoor coil temperature. Resumes operation automatically. Operating indicator (A) blinks.

Note: When switching the unit to OFF after heating operation, the unit may perform outdoor coil deicing operation. In such a case, the compressor will continue to run for some time after the unit has switched to OFF, and the indoor unit louvers are closed. This feature is a part of the normal unit operation.

CARE AND MAINTENANCE

Before performing any maintenance procedure, make sure to disconnect the air conditioner from the power.

CLEANING THE AIR FILTER

- Your air conditioner is provided with a filter cleaning indicator. When the filter indicator (E) lights up, the filters should be removed for cleaning.
- To remove the air filters, lift up the panel, push the air filters up slightly to unlock them, pull out the filters. Clean the filters by washing in warm soapy water and dry thoroughly, align and fit the filters in place, close the panel by pushing it in the center to lock it in place.
- Reset button (L) to turn off filter indicator (E).

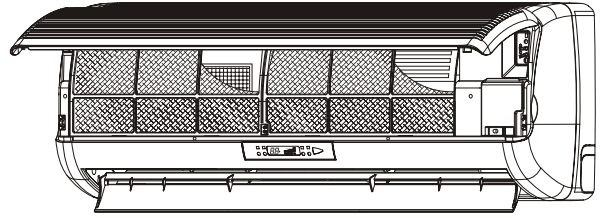

CLEANING THE ELECTROSTATIC FILTER

The electrostatic filter should be removed from the unit and cleaning once three month. The procedure is shown as following;

- 1 open the front panel
- 2 push the hook on the filter and pull out the electrostatic filter (Fig ①)
- 3 wash the filter with the warm soapy water and dry thoroughly
- 4 push the electrostatic filter into the right position
- 5 close the front panel

Note: the above procedure is used for cleaning the electrostatic filter.

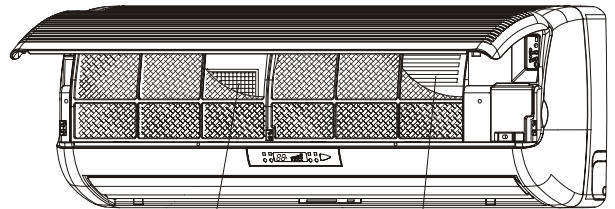

PURIFICATION FILTER REPLACEMENT

The air purifying filter should be removed from the unit and replaced once a year, shown as following:

- 1 pulling out the filter. (Fig ②)
- 2 replacing and securing the filter in its frame.
- 3 sliding the filter back in its place.

Note: The above procedure is used for replacing the active carbon filter (when supplied).

DO NOT OPERATE THE UNIT WITHOUT FILTERS!

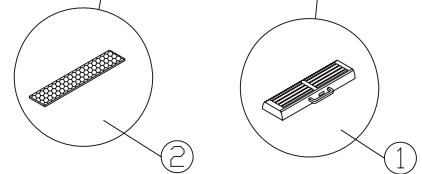

CLEANING THE AIR CONDITIONER

- Wipe the unit with a soft dry cloth or clean it using a vacuum cleaner
- Do not use hot water or volatile materials which could damage the surface of the air conditioner.

AT THE BEGINNING OF THE SEASON

- Make sure there are no obstacles blocking the flow of inlet or outlet air, in both indoor and outdoor units.
- Make sure the power is properly connected.

PROTECT THE ELECTRONIC SYSTEM

- Indoor unit and remote control must be at least 1 meter away from a TV, radio or any other home electronic appliance.
- Protect the inner unit from direct sun or lighting.

OPERATING TIPS

- Set a suitable room temperature; excessively low room temperature is not good for your health and wastes electricity. Avoid frequent setting of the temperature.
- During cooling, avoid direct sun. Keep curtains and blinds closed. Close doors and windows to keep the cool air in the room.
- Avoid generating heat or using of heating appliances while the air conditioner in cooling mode.
- Make sure that the air flap is positioned properly: horizontal flow in cooling and downward vertical flow for heating.
- Keep the room temperature uniform by adjusting the left/right vertical air blades.
- Position the air flap and the left/right air blades in such a manner as to prevent your body from being exposed directly to air drafts.
- During prolonged operation, ventilate the room occasionally by opening a window from time to time.
- In a power failure, the microprocessor memory is retained. When restarted, operation will be resumed in the last mode of operation. However, if the timer was used, the unit will be turned off by the timer only if the remote control is aimed at the unit. Otherwise the power failure will cause the timer data to be erased from the microprocessor memory.
- After turning on, allow more than 3 minutes for cooling, heating or dry operation to start.
- When COOL or DRY modes are used, make sure that the room's relative humidity is below 78%. If the unit is used for a prolonged period of time in high humidity, moisture may form on the air outlet and drip down.
- Remote control signals may not be received if the indoor unit controls cover is exposed to direct sunlight or strong light. In such a case, block the sunlight or dim the lighting.
- The remote control is operative in a range of 8 meters. If you are out of range, the remote control may have difficulties in transmitting signals.

PRECAUTIONS

- Use the proper electrical fuse.
Do not pull out the power cord unless the unit is turned off.



- Do not start or stop operation by disconnecting the power cord.



- Do not obstruct or block the air inlet or air outlet of the air conditioner.

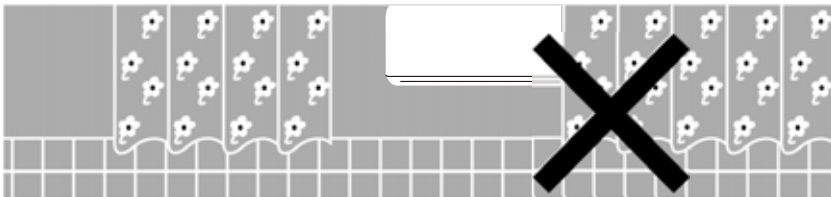

- Do not insert any objects in the air outlet of the indoor or outdoor units.



- Do not splash water on air conditioner.

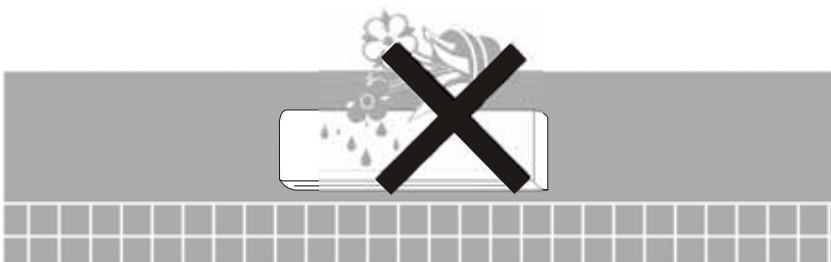

IF NOISE IS HEARD
There may be hissing sound during operation or just after shut down. This is caused by the refrigerant that is circulating inside the unit

There may be a cracking sound at starting and stopping of the unit's operation. This is caused by heat expansion or contraction of plastics.

BEFORE CALLING FOR SERVICE

Before calling for service, please check the following common malfunctions and correct as needed.

Problem	Cause	Remedy
● Unit does not operate. Stand-by indicator does not light up.	<input type="checkbox"/> Unit not connected to power <input type="checkbox"/> Power failure	<input checked="" type="checkbox"/> Plug in the power cord <input checked="" type="checkbox"/> Check main fuse
● Unit does not operate. Stand-by indicator lights.	<input type="checkbox"/> Remote control malfunctions <input type="checkbox"/> The remote control is locked.	<input checked="" type="checkbox"/> Check remote control batteries. <input checked="" type="checkbox"/> Try to operate from a closer distance. <input checked="" type="checkbox"/> Start from on-unit controls. <input checked="" type="checkbox"/> Unlock the remote control.
● Unit does not respond properly to remote control command.	<input type="checkbox"/> IR signal does not reach unit. <input type="checkbox"/> Distance between remote control and unit too large or aimed at from improper angle. <input type="checkbox"/> IR receiver on-unit exposed to strong light source.	<input checked="" type="checkbox"/> Check for obstruction between unit and remote control, Clear if needed. <input checked="" type="checkbox"/> Get closer to unit. <input checked="" type="checkbox"/> Dim lights, fluorescents especially
● Air does not blow out from indoor unit.	<input type="checkbox"/> De-icing protection mode is activated.	<input checked="" type="checkbox"/> Normal operation in HEATING mode.
● COOLING, DRY or HEATING does not start immediately.	<input type="checkbox"/> 3-min. Compressor delayed start	<input checked="" type="checkbox"/> Normal operation for these modes.
● Unit functions but does not perform sufficiently.	<input type="checkbox"/> Improper temperature setting. <input type="checkbox"/> Unit capacity insufficient for load or room size.	<input checked="" type="checkbox"/> Reset temperature. <input checked="" type="checkbox"/> Consult your dealer
● Filter indicator lights up	<input type="checkbox"/> Air Filter needs cleaning	<input checked="" type="checkbox"/> Clean filter, reinstall and reset indicator

EXCEPTION FOR MULTI-SPLIT TYPE

In multi split applications where more than a single indoor unit is connected to the same outdoor unit, it may happen that the requested operation mode can not be operated.

The reason for that is that the system is currently operating in a different mode.

The system operation mode can be either cooling or heating and is set by the outdoor unit controls, based on indoor and outdoor unit settings.

The rules for the mode settings may be different from one application to another.

In most applications the system operation mode will not be changed as long as there is an operating indoor unit requesting the active mode. The operation mode in such application will be set by the first indoor unit that is turned ON from Stand By.

The following table shows the indoor unit operation modes that can be operated per active system mode:

		System Active Mode	
		Cooling	Heating
Requested indoor unit operation mode	Cooling	v	X
	Heating	X	v
	Dry	v	X
	Auto Cool/Heat	v (cooling only)	v (heating only)
	Ventilation	v	X

(v - enabled indoor unit operation mode, X - disabled indoor unit operation mode)

Indoor unit operation when the requested mode is disabled is as following:

- Louver opens;
- Green (OPER) LED blinks once in two seconds;
- Indoor fan is forced off;

