

PAC HT 14-7: KIT SOFT START



POWER SUPPLY MUST BE SWITCHED OFF BEFORE STARTING TO WORK IN THE ELECTRIC CONTROL BOX!

MISE HORS TENSION OBLIGATOIRE AVANT TOUTE INTERVENTION DANS LES BOITIERS ELECTRIQUES.

VOR JEDEM EINGRIFF AN DEN ANSCHLUSSKÄSTEN UNBEDINGT DAS GERÄT STROMLOS SCHALTEN!

PRIMA DI OGNI INTERVENTO SULLE CASSETTE ELETTRICHE ESCLUDERE TASSATIVAMENTE L'ALIMENTAZIONE!

PUESTA FUERA DE TENSION OBLIGATORIA ANTES DE CUALQUIER INTERVENCIÓN EN LAS CAJAS ELÉCTRICAS!

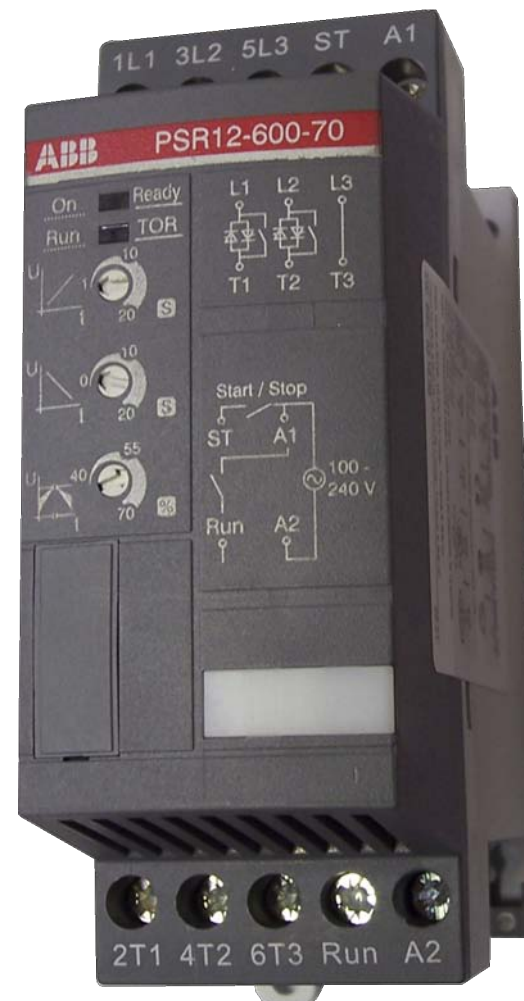

1



2

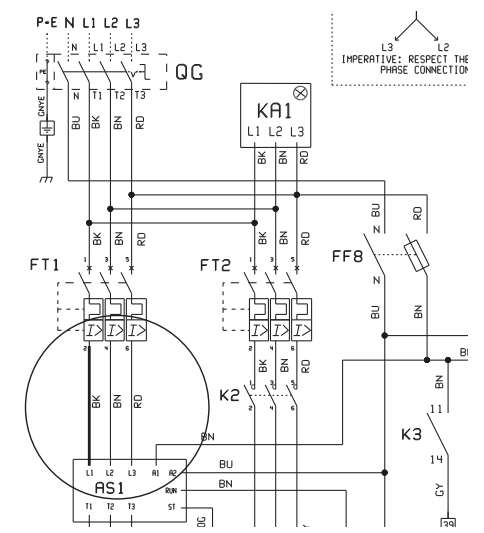
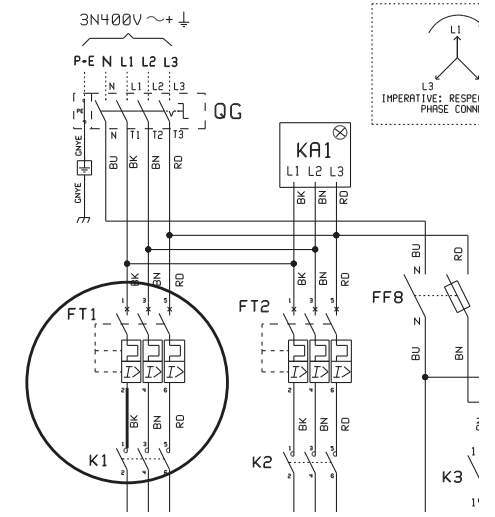

3

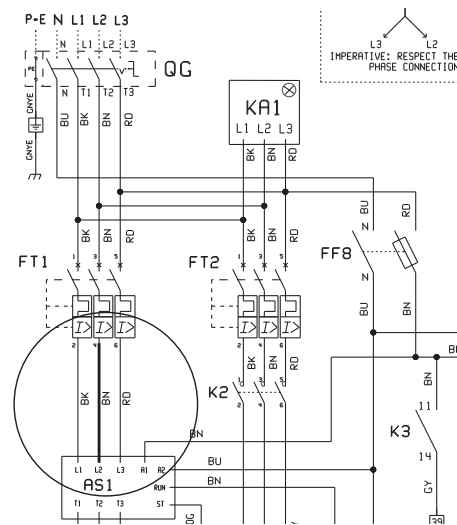
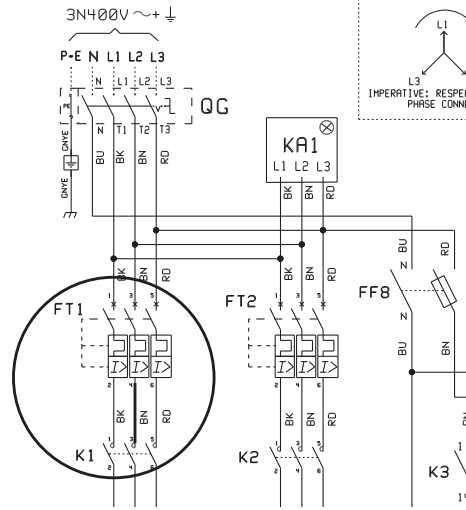

4

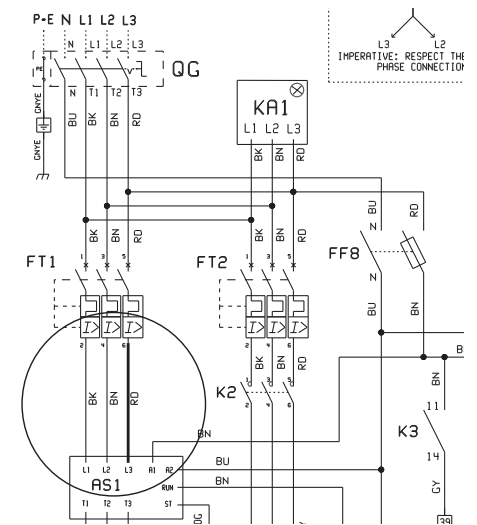
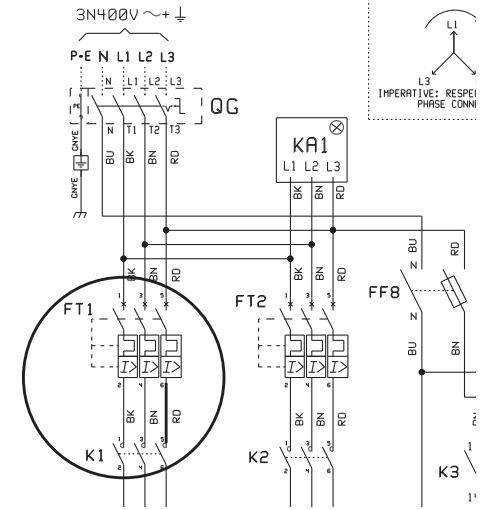

5

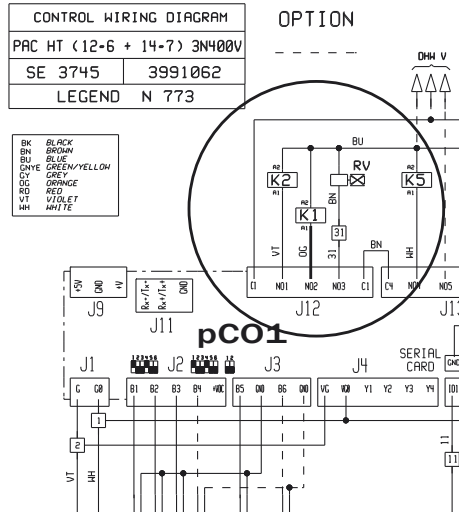

6

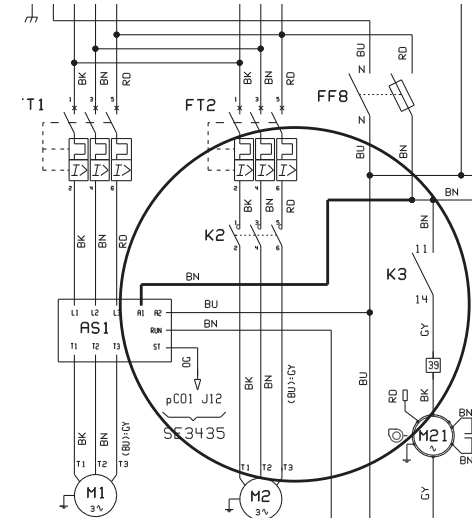
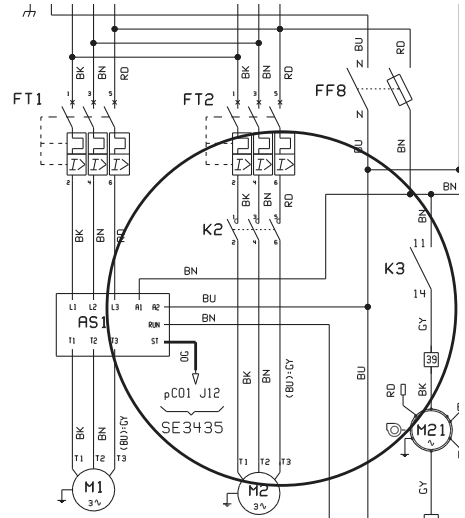
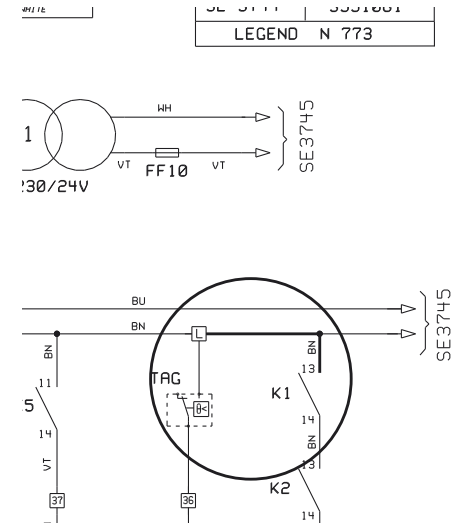
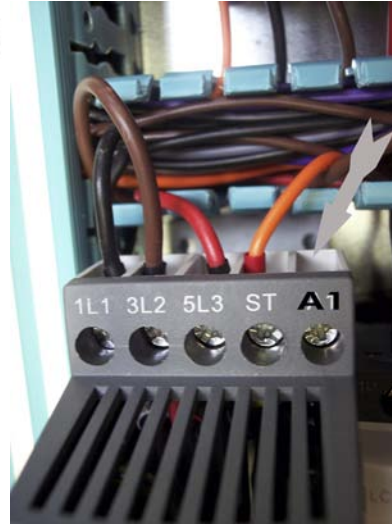

7

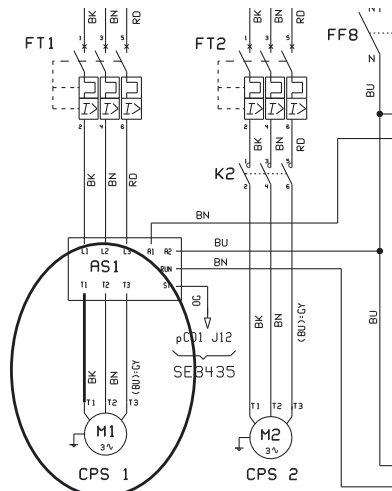
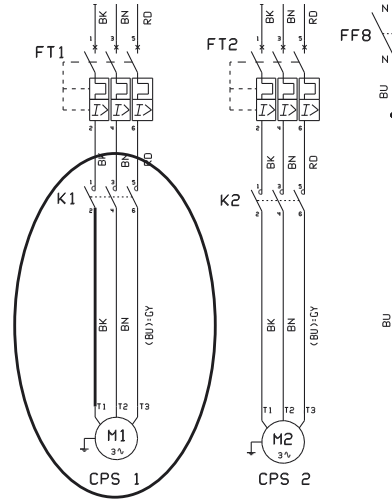

8

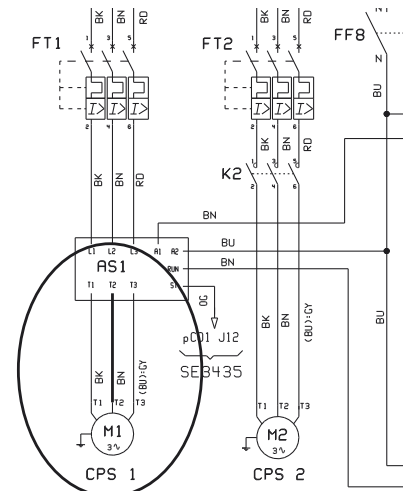
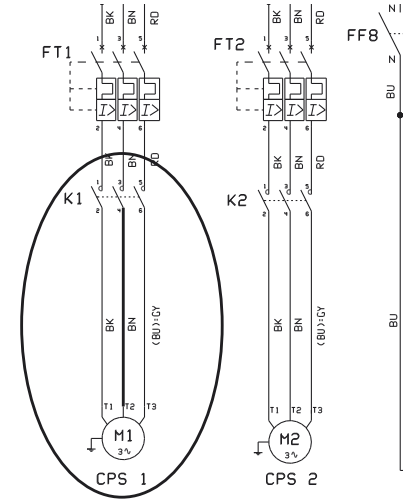

9

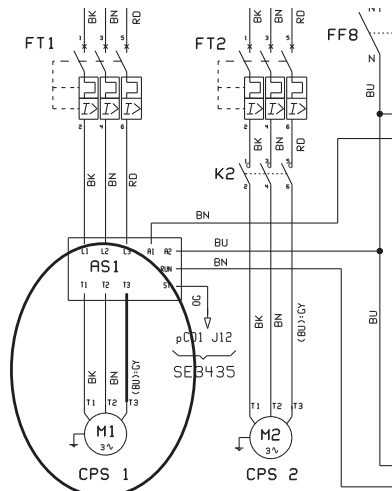
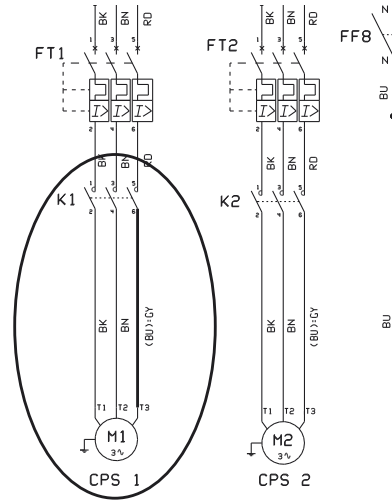

10

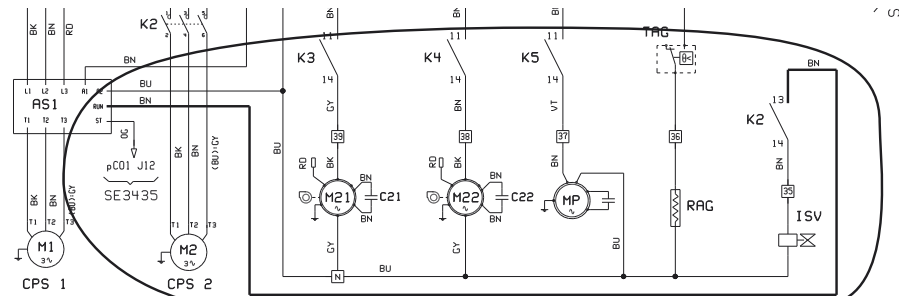
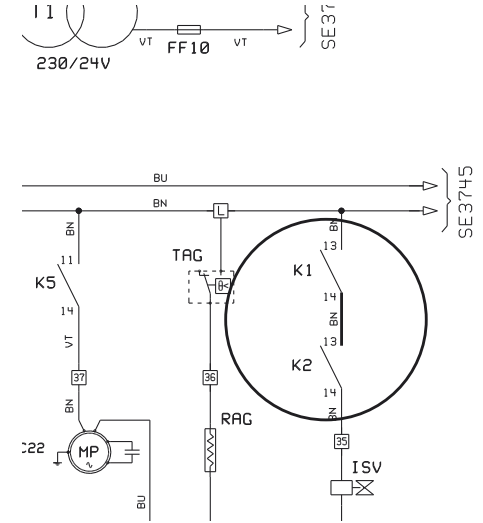

11

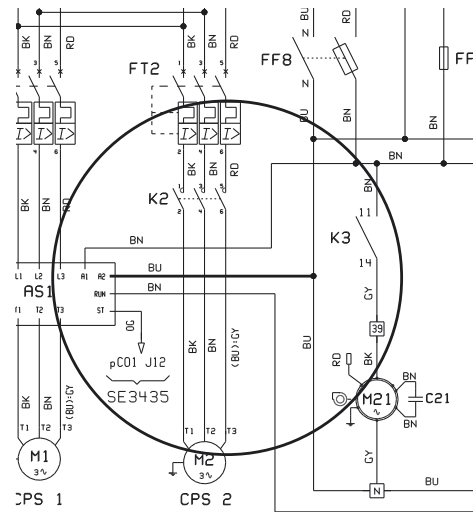
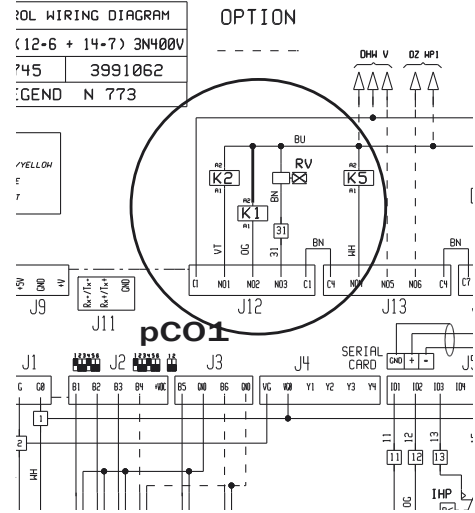

12

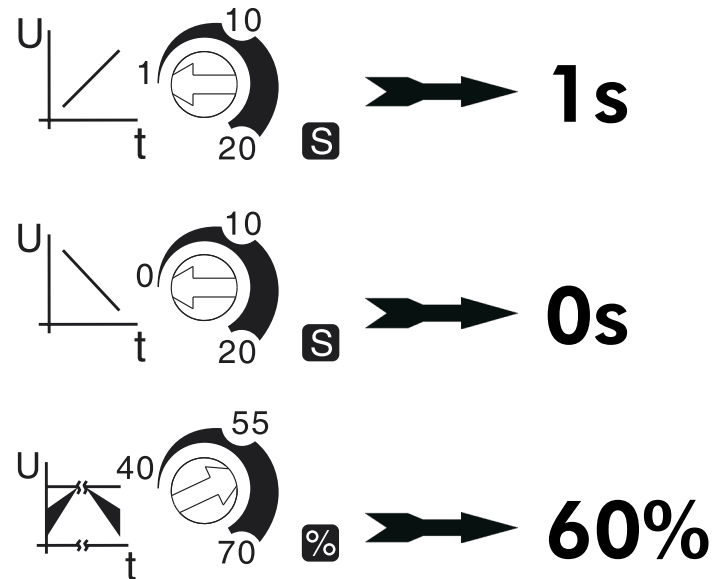
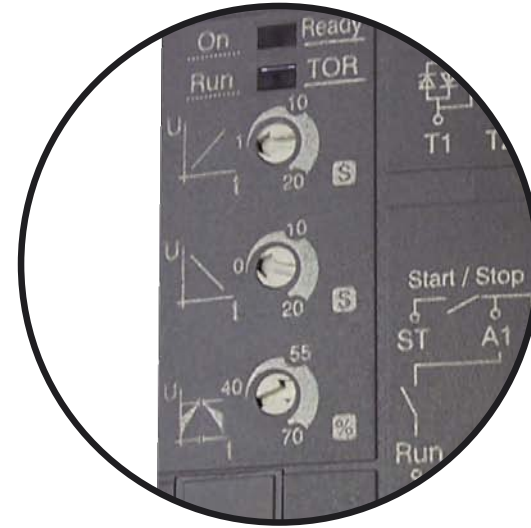

13

