



CLIMATISATION ET CHAUFFAGE

RCW11 - WIRED REMOTE CONTROLLER

Installation and Owner's Manual

COMPATIBLE FOR DDM, CDM, FDM

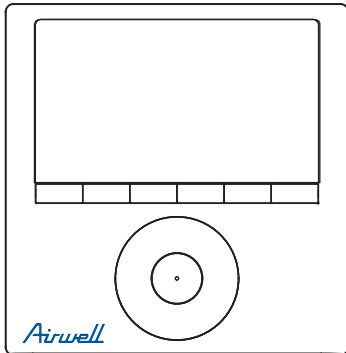

IMPORTANT NOTE:

Read this manual carefully before installing or operating your wired remote controller. Make sure to save this manual for future reference.



- This manual gives detailed description of the precautions that should be brought to your attention during operation.
- To ensure the correct service of the wired controller, read this manual carefully before using the unit.
- Keep this manual after reading for future reference.

CONTENTS

1. SAFETY PRECAUTION.....	1
2. INSTALLATION ACCESSORY.....	2
3. INSTALLATION METHOD.....	4
5. SPECIFICATION.....	16
6. WIRED CONTROLLER FEATURES AND FUNCTIONS.....	17
7. WIRED CONTROLLER DISPLAY.....	18
8. WIRED CONTROLLER BUTTONS.....	19
9. PREPARATORY OPERATION.....	20
10. OPERATION.....	21
11. TIMER FUNCTIONS.....	27
12. WEEKLY TIMER.....	30
13. SET EXTERNAL STATIC PRESSURE.....	37
14. FAULT ALARM HANDLING.....	38
15. TECHNICAL INDICATION AND REQUIREMENT	38

1. SAFETY PRECAUTION

- Read the safety precautions carefully before installing the unit.
- Stated below are important safety issues that must be obeyed.

 WARNING	Means improper handling may lead to personal death or severe injury.
 CAUTION	Means improper handling may lead to personal injury or property loss.



WARNING

Please entrust the distributor or professionals to install the unit.
Installation by other persons may lead to imperfect installation, electric shock or fire.
Adhere to this installation manual.
Improper installation may lead to electric shock or fire.
Reinstallation must be performed by professionals.

Do not uninstall the unit randomly.
Random uninstalling may lead to abnormal operation, heating or fire of the air condition.



NOTE

- ① Do not install the unit in a place vulnerable to leakage of flammable gases. Once flammable gases are leaked and left around the wire controller, fire may occur.
 - ② Do not operate with wet hands or let water enter the wire controller. Otherwise, electric shock may occur.
 - ③ The wiring should adapt to the wire controller current. Otherwise, electric leakage or heating may occur and result in fire.
 - ④ The specified cables shall be applied in the wiring. No external force may be applied to the terminal. Otherwise, wire cut and heating may occur and result in fire.
-

2. INSTALLATION ACCESSORY

Select the installation location

Don't install at the place where cover with heavy oil, vapor or sulfureted gas, otherwise, this product would be deformed that would lead to system malfunction.

Preparation before installation

1. Please confirm that all the following parts you have been supply.

No.	Name	Qty.	Remarks
1	Wire controller	1	_____
2	Installation and owner's manual	1	_____
3	Screws	3	M4X20 (For Mounting on the Wall)
4	Wall plugs	3	For Mounting on the Wall
5	Screws	2	M4X25 (For Mounting on switch box)
6	Plastic screw bars	2	For fixing on switch box
7	Battery	1	
8	The connection cable	1	(Optional)

2. Prepare the following assemblies on the site.

No.	Name	Qty.(embeded into wall)	Specification (only for reference)	Remarks
1	Switch box	1	_____	_____
2	Wiring Tube(Insulating Sleeve and Tightening Screw)	1	_____	_____

2. INSTALLATION ACCESSORY

WIRED CONTROLLER INSTALLATION PRECAUTION

1. This manual provides the wired controller installation method. Refer to the wiring diagram in this installation manual to wire the wired controller with the indoor unit.
2. The wired controller works in a low voltage loop circuit. Do not connect directly to 208/230V and 460V. Do not wire this kind of wire into a loop. Wiring clearance between the configured tubes should range 11.81–19.69 inches (30–50 cm) or above.
3. The shielded wire of the wired controller must be properly grounded.
4. Upon finish the wire controller connection, do not employed tramegger to detect the insulation.

3. INSTALLATION METHOD

1. Wired Remote Controller Dimensions

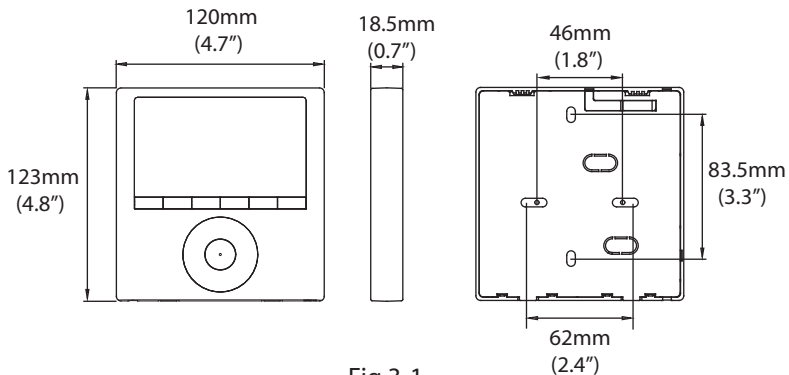

Fig 3-1

2. Wiring Connection Diagram

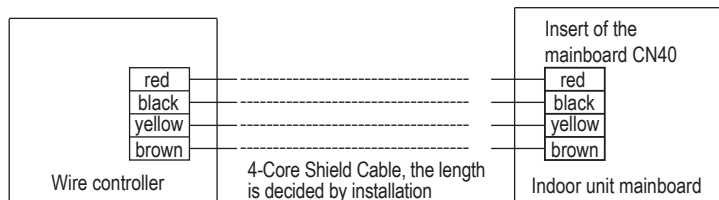
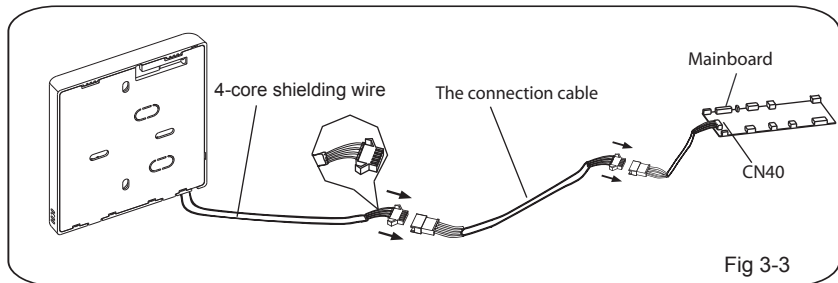

Fig 3-2

3. INSTALLATION METHOD

3.Wiring figure



- Connect the female joint of the wires group from the mainboard with the male joint of the connective wires group. (See Fig.3-3)
- Connect the other side of the connective wires group with the male joint of the wires group leads from the wire controller.(See Fig.3-3)
- Install the Adapter Board and the Display Board on the High Wall (See the Appendix for instructions).

3. INSTALLATION METHOD

4. Wire controller upper part Remove

- Insert a flat screwdriver into the slots in the lower part of the wire controller (2 places).
- Remove the upper part of the wire controller (Fig.3-4)

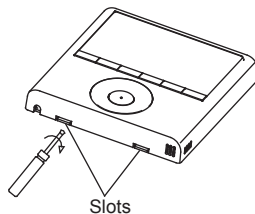

Fig 3-4

NOTE: The PCB is mounted in the upper part of the wired controller. Be careful not to damage the board with the screwdriver.

5. Fasten the wire controller back plate

- For surface mounting, fasten the back plate on the wall with the 3 screws (M4x20) and plugs. (Fig.3-5)

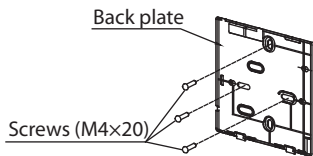

Fig 3-5

3. INSTALLATION METHOD

- For switch box mounting, fasten the back plate on the switch box with 2 screws (M4x25) and fasten it on the wall with 1 screw (M4x20). (Fig.3-6)

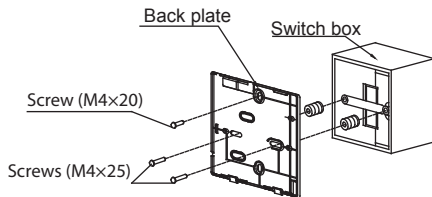

Fig 3-6

NOTE: Place on a flat surface. Be careful not to distort the wire controller's back plate by over-tightening the mounting screws.

6. Battery installation

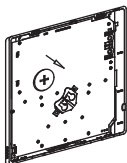

Fig 3-7

- Place the battery in the unit and ensure the positive side of the battery is in accordance with the polarity markings.(See Fig.3-7)
- Set the correct time before operating. Batteries in the wired controller can maintain the correct time during a power failure. When the power is restored and the displayed time is not correct, replace the battery.

3. INSTALLATION METHOD

7. Wire the indoor unit

There are three methods:

- 1 from the rear;
- 2 from the bottom;
- 3 from the top;

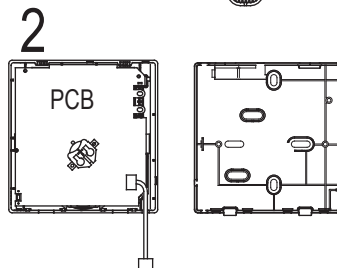
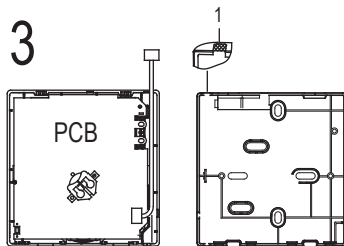
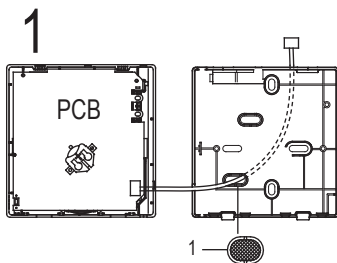

4. Notch the part for the wiring to pass through with a nipper tool.

3. INSTALLATION METHOD

NOTE: DO NOT allow water to enter the remote control. Use the trap and putty to seal the wires.

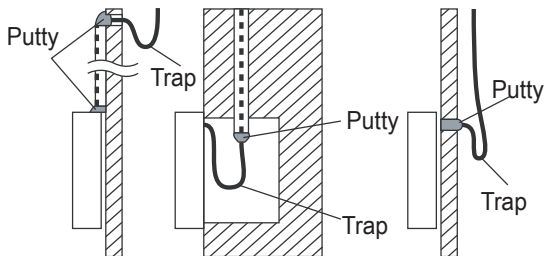

Fig 3-8

8. Reattach the wire controller's upper part

- While adjusting and mounting the upper case, avoid clamping the wiring during installation. (Fig 3-9)

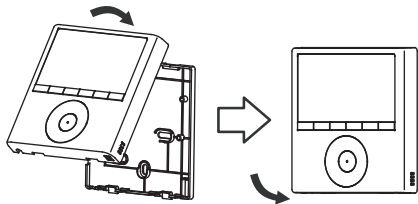

Fig 3-9

IMPORTANT: All the pictures in this manual are for illustration purposes only. Your wire controller may differ slightly.

5. SPECIFICATION

Input voltage	DC 12V
Ambient temperature	23~110°F (-5~43°C)
Ambient humidity	RH40%~RH90%

Wiring specifications

Wiring type	Size	Total length
Shielded vinyl cord or cable	0.029 in-0.74mm (0.75-1.25mm ²)	≤66 ft (20m)
		≤164 ft (50m)

6. FEATURE AND FUNCTION OF THE WIRED CONTROLLER

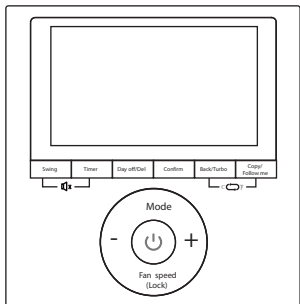

MODEL: KJR-120G2/TFBG-E-02

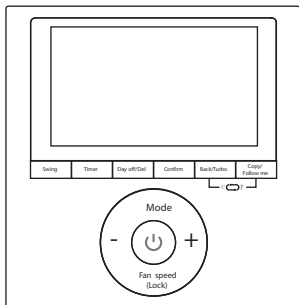

MODEL: KJR-120G1/TFBG-E

Feature:

- LCD display.
- Malfunction code display: displays the error code (helpful for servicing)
- 4-way wire layout design.
- Room temperature display.
- Weekly Timer

Function:

- Mode: choose Auto-Cool-Dry-Heat-Fan
- Fan speed: Auto-Low-Med-High
- Swing (on some models)
- Timer ON/OFF
- Temp setting
- Weekly Timer
- Follow me
- Child Lock
- LCD Display
- Clock
- Panel function (on some models)

7. WIRED CONTROLLER DISPLAY

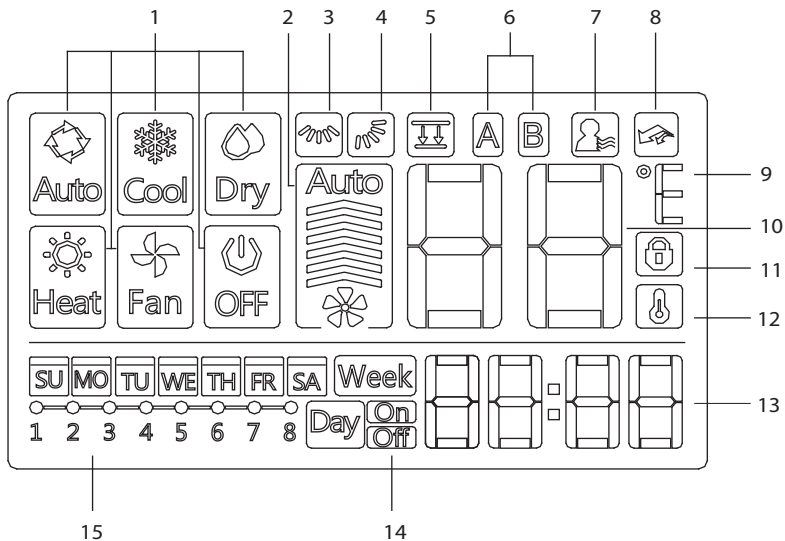

1. Operation mode indicator

2. Fan speed indicator

3. Left-right swing indicator

4. Up-down swing indicator

5. Panel function indicator

6. Main unit and secondary unit indicator

7. Follow me function indicator

8. Turbo/Auxiliary Heat function indicator

9. °C / °F indicator

10. Temperature display

11. Lock indicator

12. Room temperature indicator

13. Clock display

14. On/Off timer

15. Timer display

8. WIRED CONTROLLER BUTTONS

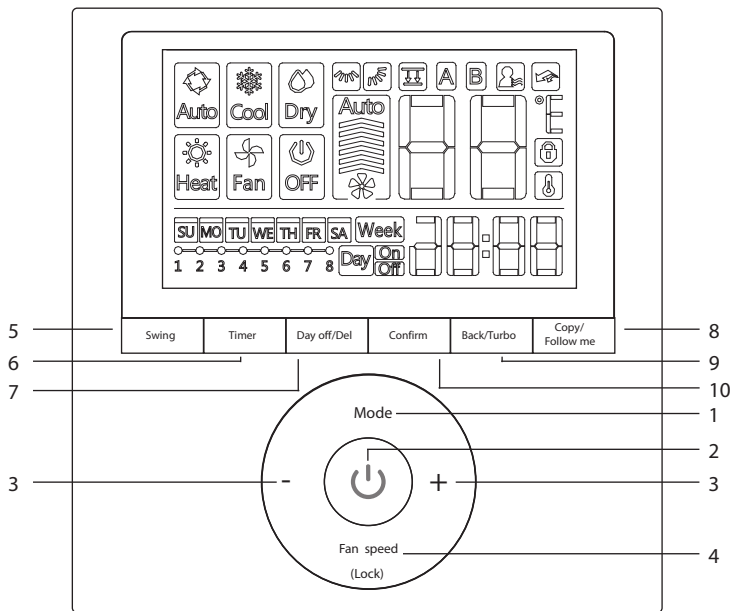



1. Mode
2. Power
3. Adjust
4. Fan Speed
5. Swing

6. Timer
7. Day Off/Del
8. Copy/Follow me
9. Back/Turbo
10. Confirm

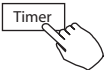

9. PREPARATORY OPERATION

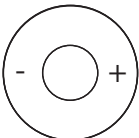
Set the current day and time

- 1  Press TIMER for 3s or more. The timer displays flashes.
-

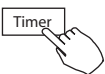
- 2  Press + or - to set the date. The selected date flashes.
- 
-

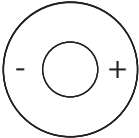
- 3  Date setting is complete and the time setting is ready after pressing TIMER or if nothing is pressed in 10 seconds.
-

- 4  Press + or - to set the current time. Press repeatedly to adjust the current time in 1 minute increments. Press and hold to adjust the current time.
- 
- ex. Monday AM 11:20
-

- 5  The setting is complete after pressing TIMER or if no button is pressed for 10 seconds.

10. OPERATION

To start/stop operation



Press the Power button.

To set the operation mode

Operation mode setting

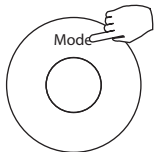

Press MODE to set the operation mode.
(Heat function is invalid for cool only type unit)

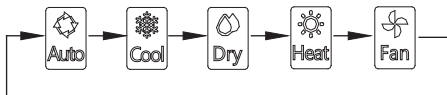

Room temperature setting

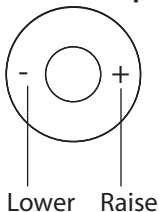

Press + or - to set the room temperature. Indoor Setting Temperature Range:
62~86°F (17~30 °C)/62~88°F (17~31 °C (depending on models)).

10. OPERATION

Fan speed setting

Press FAN SPEED to set the fan speed

NOTE: This function is unavailable in the AUTO or DRY modes.

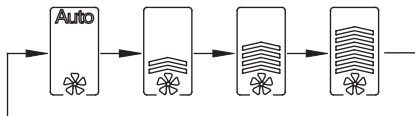
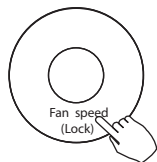

Room temperature sensor selection

Press FOLLOW ME to select whether the room temperature is detected at the indoor unit or at the wired controller.

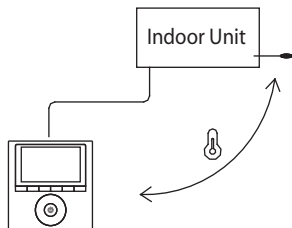
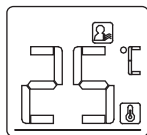
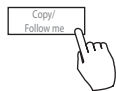

NOTE: When the FOLLOW ME function indication  appears, the room temperature is detected at the wire remote controller.

10. OPERATION

Child lock function

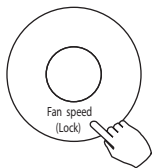

Press LOCK for 3 seconds to activate the CHILD LOCK feature and lock all buttons on the wired controller. Press again for 3 seconds to deactivate.

NOTE: When the child lock function is activated, the  lock image appears.

Keypad tone setting

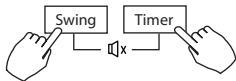

Press SWING and TIMER simultaneously for 3 seconds to disable the keypad tone. Press the buttons again for 3 seconds to enable the keypad tone.

°C & °F scale selection (on some models)

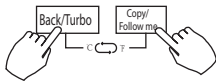

Press BACK and COPY simultaneously for 3 seconds to alternate the temperature display between the °F & °C scale.

10. OPERATION

Turbo/Auxiliary Heat function (on some models)



- Press TURBO to activate/deactivate the Turbo/Auxiliary Heat function. The turbo function sets the unit to reach the user's present temperature in the shortest amount of time possible.
- When the user presses TURBO in the COOL mode, the unit sets to the highest fan speed setting to jump—start the cooling process.
- When the user presses TURBO in the HEAT mode, for units with AUX. HEAT, the AUX. HEAT activates and jump—starts the heating process.

Lift panel function (only for some cassette specific panel)

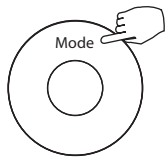

1. When the unit is off, Press the Mode button long to activate the lift panel function. The  mark will flash.

The F2 mark appears when the panel is adjusted.

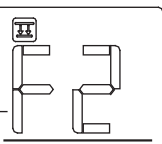

2. Press the button + and - to control the lift and drop of the panel. Pressing the + button can stop the panel, while it is dropping. Pressing the - button can stop the panel, while it is lifting.

10. OPERATION

Swing function

(For the unit with left & right auto swing function only)

1 Up-Down swing

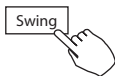

Press the Swing button to start up-down swing function.

Press it again to stop.

When the Up-Down swing function is activated, the  mark appears.

2 Left-Right swing

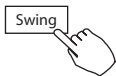

Press the Swing button long to start Left-Right swing function.

Press it again to stop.

When the Left-Right swing function is activated, the  mark appears.

10. OPERATION

Swing function

(For the unit without left & right auto swing function models)

Up-Down airflow direction and swing

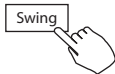

- Use SWING to adjust the up and down airflow direction.
 1. Every time the user presses SWING, the louver swings six degrees.
 2. Press and hold SWING for 2 seconds, it changes to the UP-DOWN SWING mode. Press SWING again to stop.
When the Up-Down swing function is activated, the  mark appears. (Not applicable to all the models)

- The operation can refer to the following instructions for the unit with four Up-Down louvers can be operated individually.

1. Press the Swing button to activate the Up-Down adjusting louver function.

The  mark will flash. (Not applicable to all the models)

2. Pressing the button “+” or “-” can select the movement of four louvers. Each time you push the button, the wire controller select in a sequence that goes from: (the icon  means the four louvers move at the same time.)

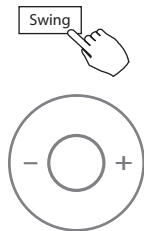
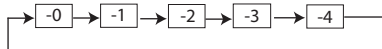

3. And then use Swing button to adjust the Up-Down airflow direction of the selected louver.

11. TIMER FUNCTIONS

Week

WEEKLY timer

Use to set the operating times for each day of the week.

Day^{On}

On timer

Use to start the air conditioner operation. The timer operates and the air conditioner operation starts after the time has passed.

Day_{Off}

Off timer

Use to stop the air conditioner operation. The timer operates and the air conditioner operation stops after the time has passed.

Day^{On}_{Off}

On and Off timer

Use to start and stop the air conditioner operation. The timer operates and the air conditioner operation starts and stops after the time has passed.

11. TIMER FUNCTIONS

To set the On or Off TIMER

- 1  Press Timer to select the Day^{On} or Day^{Off}.



- 2  Press Confirm and the Clock display flashes
-

- 3  
ex. Off timer set at PM 6:00

Press + or – to set the time. After the time is set, the timer starts or stops automatically.



- 4  Press Confirm again to finish the settings.

11. TIMER FUNCTIONS

To set the On and Off TIMER

1  Press Timer to select the .

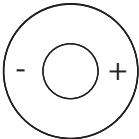
2  Press Confirm and the Clock display flashes.

3   Press the button + or - to set the On timer and then press Confirm.

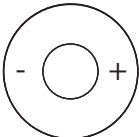
4  Press + or - to set the Off timer.

5  Press Confirm to finish the setting.

12. WEEKLY TIMER

1 Weekly timer setting



Press Timer to select the **Week** and press Confirm.

2 Day of the week setting

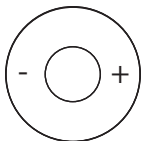

Press + or – to select the day of the week and then press CONFIRM.



3 ON timer setting of timer setting 1

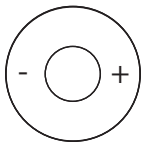

Press + and – to select the setting time. The setting time, mode, temperature and fan speed appear on the LCD. Press CONFIRM to enter the setting time process.

12. WEEKLY TIMER

IMPORTANT: Up to 8 scheduled events can be set on one day. Various events can be scheduled in either MODE, TEMPERATURE and FAN speeds.

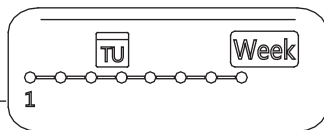

ex. Tuesday time scale 1

4 Time setting

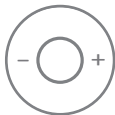

Press + and – to set the time then press CONFIRM.

5 Operation mode setting

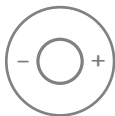

Press + and – to set the operation mode then press CONFIRM.

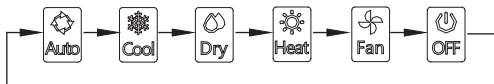

6 Room temperature setting



Press + and – to set the room temperature then press CONFIRM.

NOTE: This setting is unavailable in the FAN or OFF modes.

12. WEEKLY TIMER

7 Fan speed setting

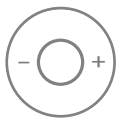

Press + and – to set the fan speed then press CONFIRM.

NOTE: This setting is unavailable in the AUTO, DRY or OFF modes.

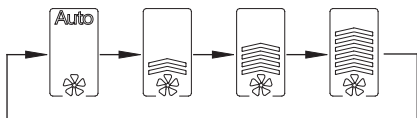

-
- 8 Different scheduled events can be set by repeating steps 3 through 7.**
 - 9 Additional days, in a one week period, can be set by repeating steps 3 through 8.**

NOTE: The weekly timer setting can be returned to the previous step by pressing BACK. The current setting is restored. The controller will not save the weekly timer settings if there is no operation within 30 seconds.

12. WEEKLY TIMER

WEEKLY timer operation

To start



Press Timer to select the **Week**, and then the timer starts automatically.

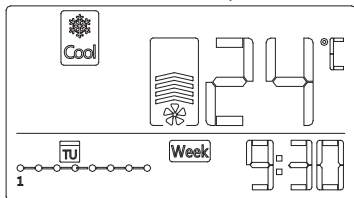

ex.

To cancel



Press Power to cancel the timer mode.



The timer mode can also be canceled by changing the timer mode using Timer.

To set the **DAY OFF** (for a holiday)



After setting the weekly timer, press CONFIRM.



Press + or – to select the day of the week.

12. WEEKLY TIMER

3



Press DAY OFF to create an off day.

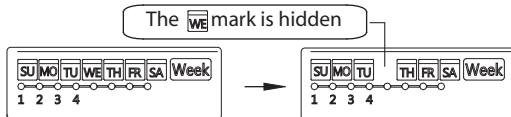

ex. The DAY OFF is set for Wednesday

4

Set the DAY OFF for other days by repeating the steps 2 and 3.

5



Press BACK to revert to the weekly timer.

- To cancel, follow the same procedures used for setup.
- NOTE: The DAY OFF setting is cancelled automatically after the set day has passed.

Copy out the setting in one day into the other day.

- A scheduled event, made once, can be copied to another day of the week. The scheduled events of the selected day of the week will be copied. The effective use of the copy mode ensures the ease of reservation making.

1



In the weekly timer, press CONFIRM.

2



Press + or – to select the day to copy from.

12. WEEKLY TIMER

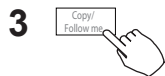

Press COPY, the letters CY appear on the LCD.



Press + or – to select the day to copy to.

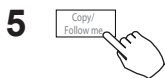

Press COPY to confirm.

The **WE** mark flashes quickly

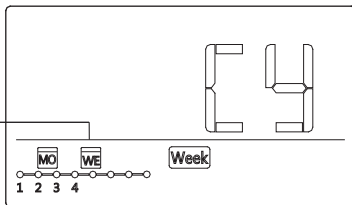

ex. Copy the setting of Monday to Wednesday

6 Other days can be copied by repeating steps 4 and 5.



Press CONFIRM to confirm the settings.



Press BACK to revert to the weekly timer.

12. WEEKLY TIMER

Delete the time scale in one day.



During the weekly timer setting, press CONFIRM.



Press + and - to select the day of the week and then press CONFIRM.



Press + and - to select the setting time want to delete. The setting time, mode, temperature and fan speed appear on the LCD. The setting time, mode, temperature and fan speed can be deleted by pressing the DEL (day off).

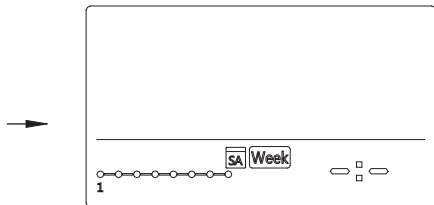
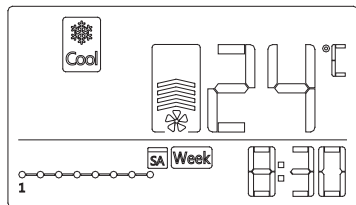

ex. Delet the time scale 1 in saturday

13. SET EXTERNAL STATIC PRESSURE

Using the wire controller to set external static pressure (some air conditioners) .

- You can use the unit's automatic airflow adjustment function to set external static pressure.
 - Automatic airflow adjustment is the volume of blow-off air that has been automatically adjusted to the quantity rated.
1. Make sure the test run is done with a dry coil. If the coil is not dry, run the unit for 2 hours in FAN ONLY mode to dry the coil.
 2. Check that both power supply wiring and duct installation have been completed. Check that any closing dampers are open.
Check that the air filter is properly attached to the air suction side passage of the unit.
 3. Set the parameters for automatic airflow adjustment. When the air conditioning unit is off, perform the following steps:

- Press "COPY" long.

- Press "+" or "-" to select the AF.

- Press "CONFIRM". The air conditioning unit will then start the fan for airflow automatic adjustment.

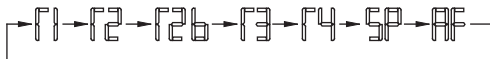

ON will flash during when the fan is on during automatic airflow adjustment.

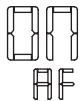

DO NOT adjust the dampers when automatic airflow adjustment is active.

After 3 to 6 minutes, the air conditioning unit stops operating once automatic airflow adjustment has finished.

Using the wire controller to set airflow rate (some air conditioners) .

When the air conditioning unit is off, perform the following steps:

- Press "COPY" long.

- Press "+" or "-" to select the SP.

- Press "CONFIRM" to set the airflow.

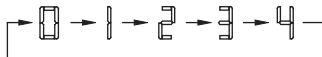

0 means a stable airflow volume, 1 to 4 means an increase in airflow volume.

- Press "BACK" to finish the setting.

14. FAULT ALARM HANDING

If the system does not properly operate except in the aforementioned cases or the aforementioned malfunctions are evident, investigate the system according to the following procedures.

NO.	MALFUNCTION AND PROTECTION DEFINITION	DISPLAY DIGITAL TUBE
1	Communication error between wired controller and indoor unit	F0
2	The auto-lifing panel is abnormal	F1

Please check the indoor unit's error display and review the owner's manual if other error codes appear.

15. TECHNICAL INDICATION AND REQUIREMENT

EMC and EMI comply with the CE certification requirements.



CLIMATISATION ET CHAUFFAGE

WARNING :

The design and specifications are subject to change without prior notice for product improvement. Consult with the sales agency or manufacturer for details.

ATTENTION :

Le design et les données techniques sont donnés à titre indicatif et peuvent être modifiés sans préavis.



AIRWELL RESIDENTIAL SAS

3 Avenue du Centre - Les Quadrants - Bâtiment

A 78280 Guyancourt - France

www.airwell-pro.com