



CLIMATISATION ET CHAUFFAGE

---

## RCW22 - WIRED REMOTE CONTROLLER

# Installation and Owner's Manual

COMPATIBLE FOR HDH & XDM

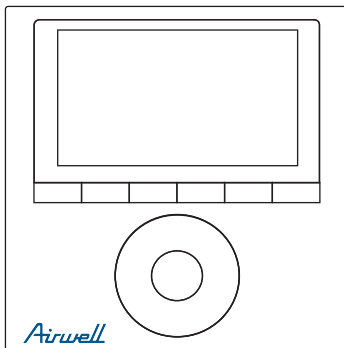

### **IMPORTANT NOTE:**

Read this manual carefully before installing or operating your wired remote controller. Make sure to save this manual for future reference.

- This manual gives detailed description of the precautions that should be brought to your attention during operation.
- To ensure the correct service of the wired controller, read this manual carefully before using the unit.
- Keep this manual after reading for future reference.



# CONTENTS

1. SAFETY PRECAUTION.....	1
2. INSTALLATION ACCESSORY.....	2
3. INSTALLATION METHOD.....	4
4. APPENDIX INSTALL THE WIRE CONTROLLER KIT.....	10
5. SPECIFICATION.....	16
6. WIRED CONTROLLER FEATURES AND FUNCTIONS.....	17
7. WIRED CONTROLLER DISPLAY.....	18
8. WIRED CONTROLLER BUTTONS.....	19
9. PREPARATORY OPERATION.....	20
10. OPERATION.....	21
11. TIMER FUNCTIONS.....	27
12. WEEKLY TIMER.....	30
13. FAULT ALARM HANDING.....	37
14. TECHNICAL INDICATION AND REQUIREMENT .....	37

# 1. SAFETY PRECAUTION

---

- Read the safety precautions carefully before installing the unit.
- Stated below are important safety issues that must be obeyed.

 <b>WARNING</b>	Means improper handling may lead to personal death or severe injury.
 <b>CAUTION</b>	Means improper handling may lead to personal injury or property loss.



## WARNING

---

Please entrust the distributor or professionals to install the unit.  
Installation by other persons may lead to imperfect installation, electric shock or fire.  
Adhere to this installation manual.  
Improper installation may lead to electric shock or fire.  
Reinstallation must be performed by professionals.

---

Do not uninstall the unit randomly.  
Random uninstalling may lead to abnormal operation, heating or fire of the air condition.



## NOTE

---

- ① Do not install the unit in a place vulnerable to leakage of flammable gases. Once flammable gases are leaked and left around the wire controller, fire may occur.
  - ② Do not operate with wet hands or let water enter the wire controller. Otherwise, electric shock may occur.
  - ③ The wiring should adapt to the wire controller current. Otherwise, electric leakage or heating may occur and result in fire.
  - ④ The specified cables shall be applied in the wiring. No external force may be applied to the terminal. Otherwise, wire cut and heating may occur and result in fire.
-

## 2. INSTALLATION ACCESSORY

---

### Select the installation location

Don't install at the place where cover with heavy oil, vapor or sulfureted gas, otherwise, this product would be deformed that would lead to system malfunction.

### Preparation before installation

1. Please confirm that all the following parts you have been supply.

No.	Name	Qty.	Remarks
1	Wire controller	1	_____
2	Installation and owner's manual	1	_____
3	Screws	3	M4X20 (For Mounting on the Wall)
4	Wall plugs	3	For Mounting on the Wall
5	Screws	2	M4X25 (For Mounting on switch box)
6	Plastic screw bars	2	For fixing on switch box
7	Battery	1	
8	The connection cable	1	

2. Prepare the following assemblies on the site.

No.	Name	Qty.(embedded into wall)	Specification (only for reference)	Remarks
1	Switch box	1	_____	_____
2	Wiring Tube(Insulating Sleeve and Tightening Screw)	1	_____	_____

## 2. INSTALLATION ACCESSORY

---

### WIRED CONTROLLER INSTALLATION PRECAUTION

1. This manual provides the wired controller installation method. Refer to the wiring diagram in this installation manual to wire the wired controller with the indoor unit.
2. The wired controller works in a low voltage loop circuit. Do not connect directly to 208/230V and 460V. Do not wire this kind of wire into a loop. Wiring clearance between the configured tubes should range 11.81–19.69 inches (30–50 cm) or above.
3. The shielded wire of the wired controller must be properly grounded.
4. Upon finish the wire controller connection, do not employed tramegger to detect the insulation.

### 3. INSTALLATION METHOD

#### 1. Wired Remote Controller Dimensions

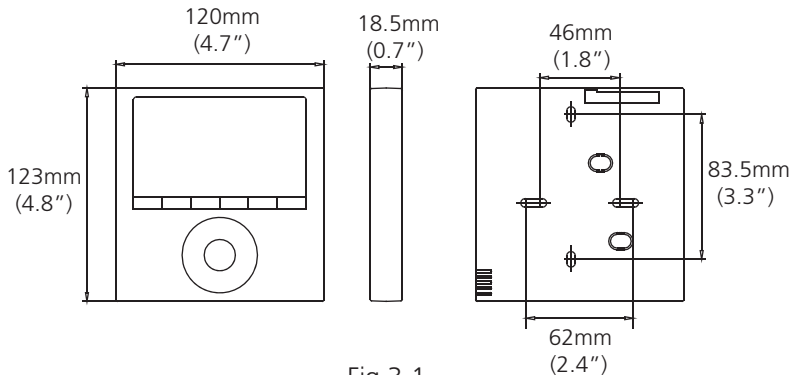

Fig 3-1

#### 2. Wiring Connection Diagram

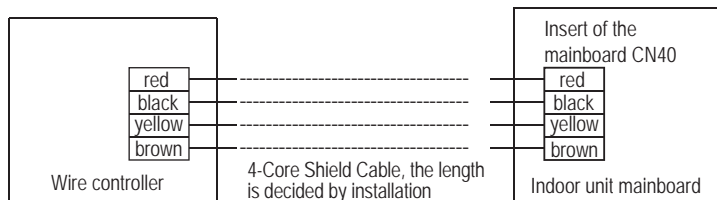
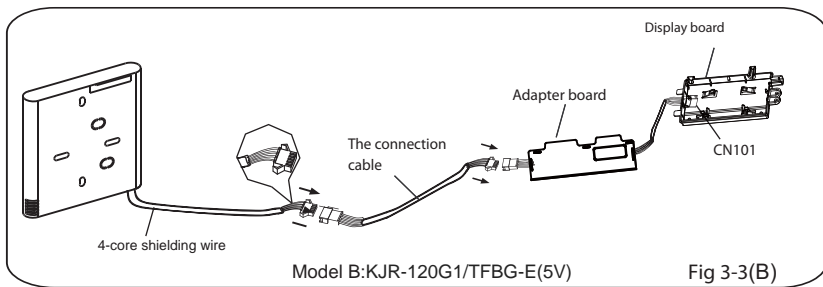

Fig 3-2

## 3. INSTALLATION METHOD

### 3.Wiring figure



- Install the Adapter Board and the Display Board on the High Wall (See the Appendix for instructions).
- Connect the female joint of the wires group from the adapter board with the male joint of the connective wires group. Next, connect the other side of the adapter board with the displayboard. (See Fig.3-3(B))
- Connect the other side of the connective wires group with the male joint of the wires group leads from the wire controller. (See Fig.3-3(B))



### 3. INSTALLATION METHOD

---

#### 4. Wire controller upper part Remove

- Insert a flat screwdriver into the slots in the lower part of the wire controller (2 places).
- Remove the upper part of the wire controller (Fig.3-4)

**NOTE:** The PCB is mounted in the upper part of the wired controller. Be careful not to damage the board with the screwdriver.

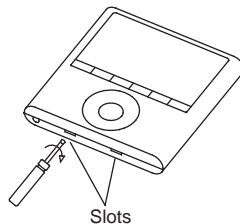

Fig 3-4

#### 5. Fasten the wire controller back plate

- For surface mounting, fasten the back plate on the wall with the 3 screws (M4x20) and plugs. (Fig.3-5)

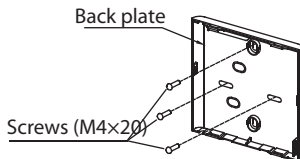

Fig 3-5

### 3. INSTALLATION METHOD

---

- For switch box mounting, fasten the back plate on the switch box with 2 screws (M4x25) and fasten it on the wall with 1 screw (M4x20). (Fig.3-6)

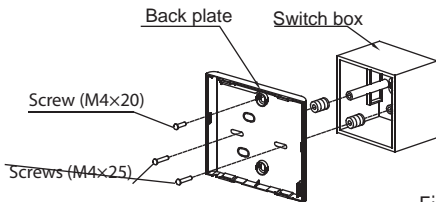

Fig 3-6

**NOTE:** Place on a flat surface. Be careful not to distort the wire controller's back plate by over-tightening the mounting screws.

### 6. Battery installation

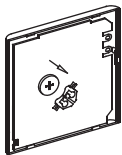

Fig 3-7

- Place the battery in the unit and ensure the positive side of the battery is in accordance with the polarity markings.(See Fig.3-7)
- Set the correct time before operating. Batteries in the wired controller can maintain the correct time during a power failure. When the power is restored and the displayed time is not correct, replace the battery.

### 3. INSTALLATION METHOD

---

#### 7. Wire the indoor unit

There are three methods:

- 1 from the rear;
- 2 from the bottom;
- 3 from the top;

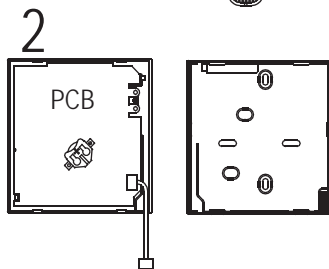
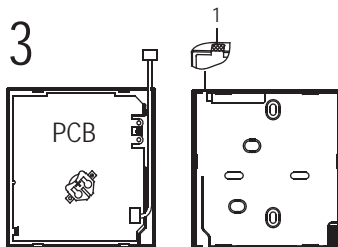
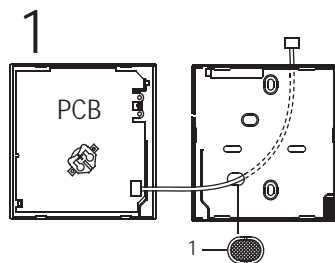

4. Notch the part for the wiring to pass through with a nipper tool.

### 3. INSTALLATION METHOD

---

**NOTE: DO NOT** allow water to enter the remote control. Use the trap and putty to seal the wires.

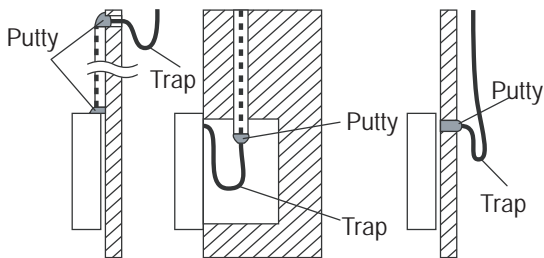

Fig 3-8

#### 8. Reattach the wire controller's upper part

- While adjusting and mounting the upper case, avoid clamping the wiring during installation. (Fig 3-9)

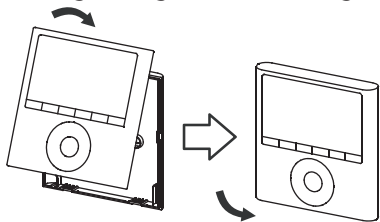

Fig 3-9

**IMPORTANT:** All the pictures in this manual are for illustration purposes only. Your wire controller may differ slightly.

## 4. APPENDIX

### INSTALL THE WIRE CONTROLLER KIT

---

1. Open the front panel.



2. Disconnect the wire from the main controller board.



## 4. APPENDIX

### INSTALL THE WIRE CONTROLLER KIT

---

3. Disconnect the wire of the Wifi PCB (CN206)



## 4. APPENDIX

### INSTALL THE WIRE CONTROLLER KIT

---

4. Connect the display board to the adaptor board (1)
5. Connect the wire remote controller to the adaptor board (2)

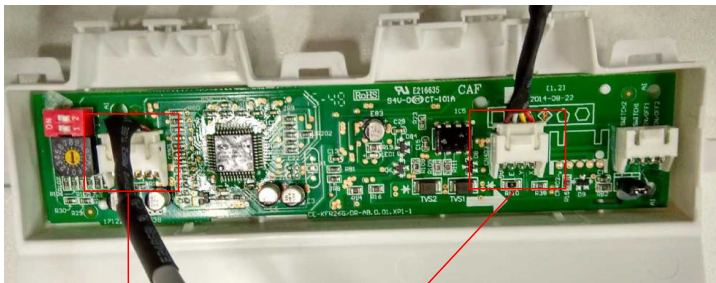

(1)

(2)

## 4. APPENDIX

### INSTALL THE WIRE CONTROLLER KIT

---

6. Place the adaptor board on the front panel

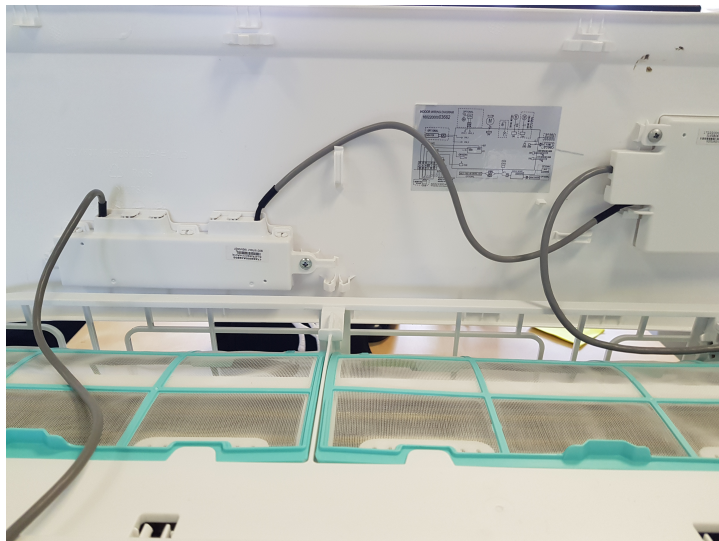



## 5. SPECIFICATION

---

Input voltage	DC 5V
Ambient temperature	23~110°F (-5~43°C)
Ambient humidity	RH40%~RH90%

### Wiring specifications

Wiring type	Size	Total length
Shielded vinyl cord or cable	0.029 in-0.74mm (0.75-1.25mm <sup>2</sup> )	≤66 ft (20m)
		≤164 ft (50m)

## 6. FEATURE AND FUNCTION OF THE WIRED CONTROLLER

---

Feature:

- LCD display.
- Malfunction code display: displays the error code (helpful for servicing)
- 4-way wire layout design.
- Room temperature display.
- Weekly Timer

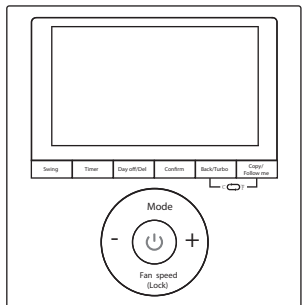

Function:

- Mode: choose Auto-Cool-Dry-Heat-Fan
- Fan speed: Auto-Low-Med-High
- Swing(on some models)
- Timer ON/OFF
- Temp setting
- Weekly Timer
- Follow me
- Child Lock
- LCD Display
- Clock
- Panel function (on some models)

## 7. WIRED CONTROLLER DISPLAY

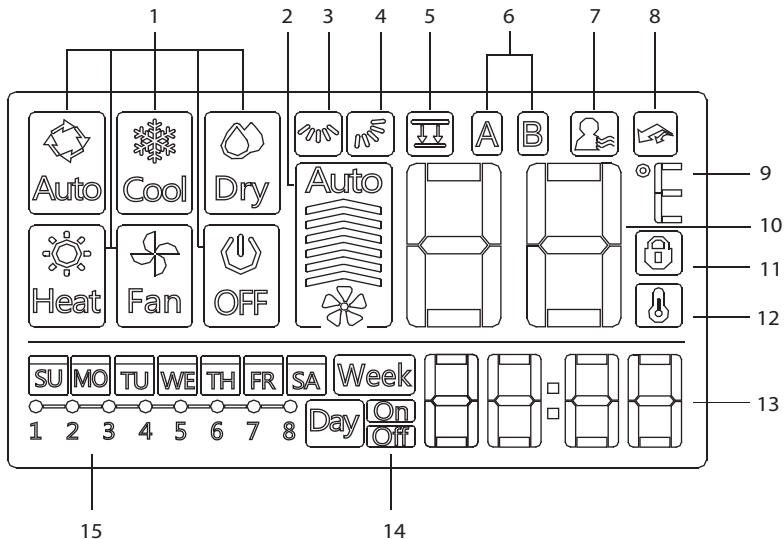

1. Operation mode indicator

2. Fan speed indicator

3. Left-right swing indicator

4. Up-down swing indicator

5. Faceplate function indicator

6. Main unit and secondary unit indicator

7. Follow me function indicator

16

8. Turbo/Auxiliary Heat function indicator

9. °C / °F indicator

10. Temperature display

11. Lock indicator

12. Room temperature indicator

13. Clock display

14. On/Off timer

15. Timer display

## 8. WIRED CONTROLLER BUTTONS

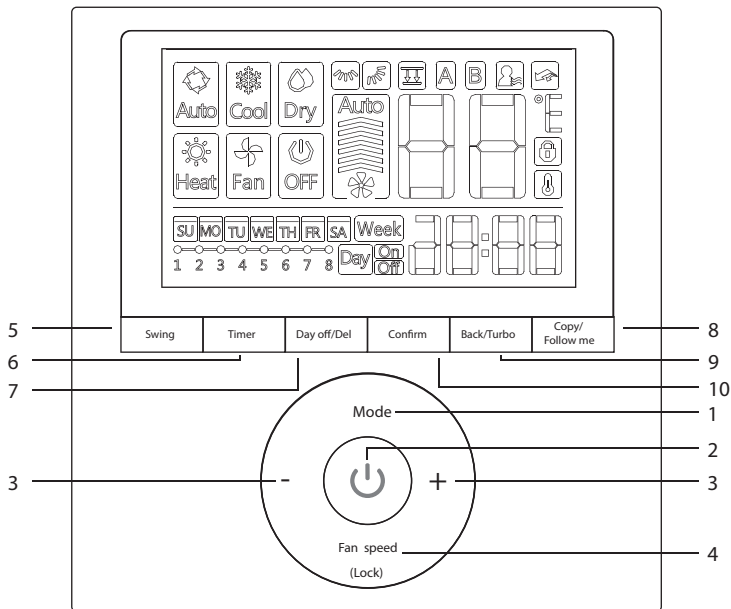

1. Mode
2. Power
3. Adjust
4. Fan Speed
5. Swing



6. Timer
7. Day Off/Del
8. Copy/Follow me
9. Back/Turbo
10. Confirm

## 9. PREPARATORY OPERATION

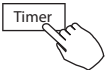

---

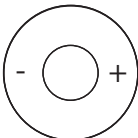
### Set the current day and time

- 1  Press **TIMER** for 3s or more. The timer displays flashes.
- 

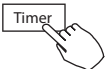
- 2  Press + or – to set the date. The selected date flashes.
- 
- The diagram shows a sequence of seven boxes representing days of the week: SU, MO, TU, WE, TH, FR, SA. Arrows point from left to right between each box, and a line connects the SA box back to the SU box, forming a loop.
- 

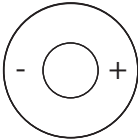
- 3  Date setting is complete and the time setting is ready after pressing **TIMER** or if nothing is pressed in 10 seconds.
- 

- 4  Press + or – to set the current time. Press repeatedly to adjust the current time in 1 minute increments. Press and hold to adjust the current time.
- 
- The diagram shows a digital display with a small box on the left containing 'MO', followed by a colon, and then the numbers '11:20'.
- ex.Monday AM 11:20
- 

- 5  The setting is complete after pressing **TIMER** or if no button is pressed for 10 seconds.

## 10. OPERATION

---

### To start/stop operation



Press the Power button.

### To set the operation mode

#### Operation mode setting

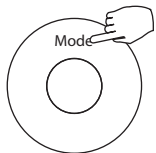

Press MODE to set the operation mode.  
(Heat function is invalid for cool only type unit)

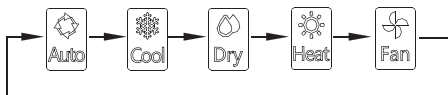

#### Room temperature setting

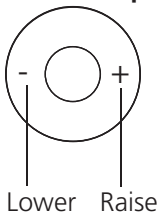

Press + or - to set the room temperature. Indoor  
Setting Temperature Range:  
62~86°F (17~30°C)/62~88°F (17~31°C (depending  
on models)).

## 10. OPERATION

### Fan speed setting

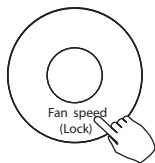

Press **FAN SPEED** to set the fan speed

**NOTE:** This function is unavailable in the **AUTO** or **DRY** modes.

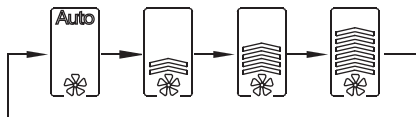

### Room temperature sensor selection

Press **FOLLOW ME** to select whether the room temperature is detected at the indoor unit or at the wired controller.

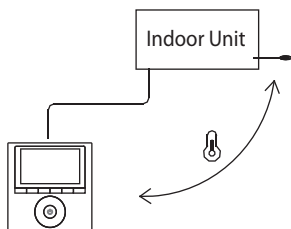
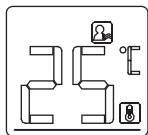
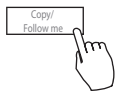

**NOTE:** When the **FOLLOW ME** function indication  appears, the room temperature is detected at the wire remote controller.

## 10. OPERATION

---

### Child lock function

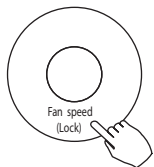

Press **LOCK** for 3 seconds to activate the **CHILD LOCK** feature and lock all buttons on the wired controller. Press again for 3 seconds to deactivate.

**NOTE:** When the child lock function is activated, the  lock image appears.

### keypad tone setting

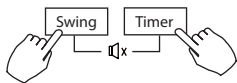

Press SWING and TIMER simultaneously for 3 seconds to disable the keypad tone. Press the buttons again for 3 seconds to enable the keypad tone.

### °C & °F scale selection (on some models)

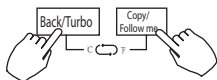

Press BACK and COPY simultaneously for 3 seconds to alternate the temperature display between the °F & °C scale.



## 10. OPERATION

---

### Turbo/Auxiliary Heat function (on some models)



- Press **TURBO** to activate/deactivate the Turbo/Auxiliary Heat function. The turbo function sets the unit to reach the user's present temperature in the shortest amount of time possible.
- When the user presses **TURBO** in the **COOL** mode, the unit sets to the highest fan speed setting to jump-start the cooling process.
- When the user presses **TURBO** in the **HEAT** mode, for units with **AUX. HEAT**, the AUX. HEAT activates and jump-starts the heating process.

### Lift panel function (only for some cassette specific panel)

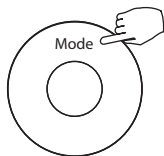

1. When the unit is off, Press the Mode button long to activate the lift panel function. The  mark will flash.

The F2 mark appears when the panel is adjusted.

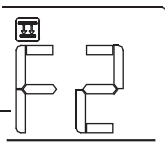

2. Press the button + and - to control the lift and drop of the panel. Pressing the + button can stop the panel, while it is dropping. Pressing the - button can stop the panel, while it is lifting.

## 10. OPERATION

---

### Swing function

(For the unit with left & right auto swing function only)

#### 1 Up-Down swing

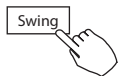

Press the **Swing** button to start up-down swing function.

Press it again to stop.

When the Up-Down swing function is activated, the  mark appears.

#### 2 Left-Right swing

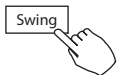

Press the **Swing** button long to start Left-Right swing function.

Press it again to stop.

When the Left-Right swing function is activated, the  mark appears.

## 10. OPERATION

---

### Swing function

(For the unit without left & right auto swing function models)

#### Up-Down airflow direction and swing

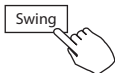

- Use **SWING** to adjust the up and down airflow direction.
  1. Every time the user presses **SWING**, the louver swings six degrees.
  2. Press and hold **SWING** for 2 seconds, it changes to the **UP-DOWN SWING** mode. Press **SWING** again to stop.  
When the **Up-Down** swing function is activated, the  mark appears. (Not applicable to all the models)

- The operation can refer to the following instructions for the unit with four Up-Down louvers can be operated individually.

1. Press the **Swing** button to activate the **Up-Down** adjusting louver function.

The  mark will flash. (Not applicable to all the models)

2. Pressing the button “+” or “-” can select the movement of four louvers. Each time you push the button, the wire controller select in a sequence that goes from: (the icon  means the four louvers move at the same time.)

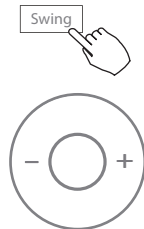
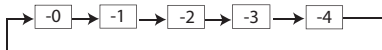

3. And then use **Swing** button to adjust the Up-Down airflow direction of the selected louver.

## 11. TIMER FUNCTIONS

---

 Week

WEEKLY timer

Use to set the operating times for each day of the week.

 Day On

On timer

Use to start the air conditioner operation. The timer operates and the air conditioner operation starts after the time has passed.

 Day Off

Off timer

Use to stop the air conditioner operation. The timer operates and the air conditioner operation stops after the time has passed.

 Day On Off

On and Off timer

Use to start and stop the air conditioner operation. The timer operates and the air conditioner operation starts and stops after the time has passed.

## 11. TIMER FUNCTIONS

---

### To set the On or Off TIMER

1  Press **Timer** to select the  or .



2  Press **Confirm** and the Clock display flashes

---

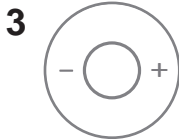

ex. Off timer set at PM 6:00

Press **+** or **-** to set the time. After the time is set, the timer starts or stops automatically.

---

4  Press **Confirm** again to finish the settings.

## 11. TIMER FUNCTIONS

---

### To set the On and Off TIMER

1  Press **Timer** to select the .

---

2  Press **Confirm** and the Clock display flashes.

---

3   Press the button **+** or **-** to set the **On timer** and then press **Confirm**.

---

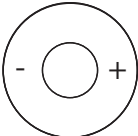
4  Press **+** or **-** to set the **Off timer**.

---

5  Press **Confirm** to finish the setting.

## 12. WEEKLY TIMER

---

### 1 Weekly timer setting



Press **Timer** to select the **Week** and press **Confirm**.

### 2 Day of the week setting

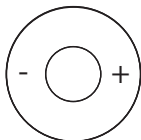

Press **+** or **-** to select the day of the week and then press **CONFIRM**.



### 3 ON timer setting of timer setting 1

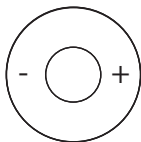

Press **+** and **-** to select the setting time. The setting time, mode, temperature and fan speed appear on the LCD. Press **CONFIRM** to enter the setting time process.

## 12. WEEKLY TIMER

**IMPORTANT:** Up to 8 scheduled events can be set on one day. Various events can be scheduled in either **MODE**, **TEMPERATURE** and **FAN** speeds.

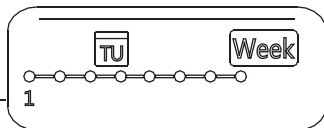

ex. Tuesday time scale 1

### 4 Time setting



Press **+** and **-** to set the time then press **CONFIRM**.

### 5 Operation mode setting



Press **+** and **-** to set the operation mode then press **CONFIRM**.

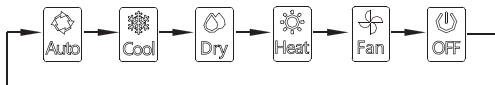

### 6 Room temperature setting



Press **+** and **-** to set the room temperature then press **CONFIRM**.

**NOTE:** This setting is unavailable in the **FAN** or **OFF** modes.



## 12. WEEKLY TIMER

---

### 7 Fan speed setting

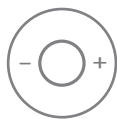

Press + and – to set the fan speed then press **CONFIRM**.

**NOTE:** This setting is unavailable in the **AUTO**, **DRY** or **OFF** modes.

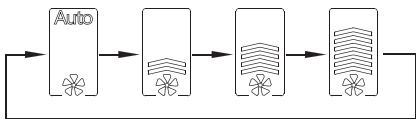

- 
- 8 Different scheduled events can be set by repeating steps 3 through 7.**
  - 9 Additional days, in a one week period, can be set by repeating steps 3 through 8.**

**NOTE:** The weekly timer setting can be returned to the previous step by pressing **BACK**. The current setting is restored. The controller will not save the weekly timer settings if there is no operation within 30 seconds.

## 12. WEEKLY TIMER

---

### WEEKLY timer operation

To start



Press **Timer** to select the **Week**, and then the timer starts automatically.

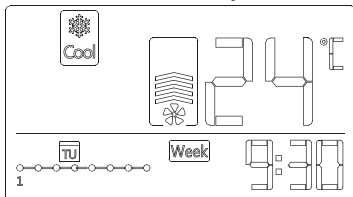

To cancel



Press **Power** to cancel the timer mode.



The timer mode can also be canceled by changing the timer mode using **Timer**.

### To set the DAY OFF (for a holiday)



After setting the weekly timer, press **CONFIRM**.

---



Press **+** or **-** to select the day of the week.

## 12. WEEKLY TIMER

---

3



Press **DAY OFF** to create an off day.



ex. The DAY OFF is set for Wednesday

---

4

Set the **DAY OFF** for other days by repeating the steps 2 and 3.

---

5



Press **BACK** to revert to the weekly timer.

---

- To cancel, follow the same procedures used for setup.
- **NOTE:** The **DAY OFF** setting is cancelled automatically after the set day has passed.

### Copy out the setting in one day into the other day.

- A scheduled event, made once, can be copied to another day of the week. The scheduled events of the selected day of the week will be copied. The effective use of the copy mode ensures the ease of reservation making.

1



In the weekly timer, press **CONFIRM**.

---

2



Press **+** or **-** to select the day to copy from.

## 12. WEEKLY TIMER

---

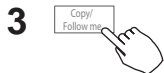

Press **COPY**, the letters **CY** appear on the LCD.

---



Press **+** or **-** to select the day to copy to.

---



Press **COPY** to confirm.

The **WE** mark flashes quickly

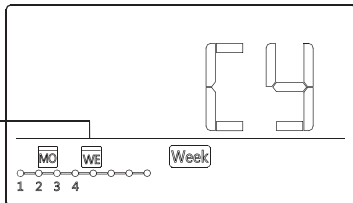

ex. Copy the setting of Monday to Wednesday

---

6 Other days can be copied by repeating steps 4 and 5.

---



Press **CONFIRM** to confirm the settings.

---



Press **BACK** to revert to the weekly timer.

## 12. WEEKLY TIMER

### Delete the time scale in one day.



During the weekly timer setting, press **CONFIRM**.



Press **+** and **-** to select the day of the week and then press **CONFIRM**.



Press **+** and **-** to select the setting time want to delete. The setting time, mode, temperature and fan speed appear on the LCD. The setting time, mode, temperature and fan speed can be deleted by pressing the **DEL** (day off).

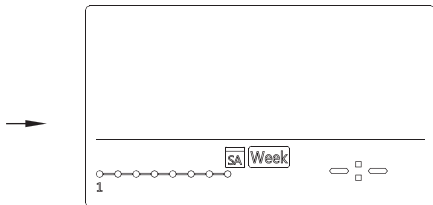
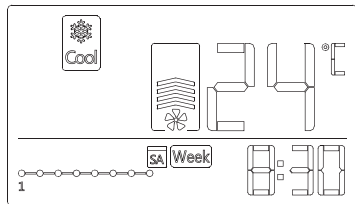

ex. Delete the time scale 1 in saturday

### 13. FAULT ALARM HANDING

---

If the system does not properly operate except in the aforementioned cases or the aforementioned malfunctions are evident, investigate the system according to the following procedures.

NO.	MALFUNCTION AND PROTECTION DEFINITION	DISPLAY DIGITAL TUBE
1	Communication error between wired controller and indoor unit	F0
2	The faceplate is abnormal	F1

Please check the indoor unit's error display and review the owner's manual if other error codes appear.

### 14. TECHNICAL INDICATION AND REQUIREMENT

---

EMC and EMI comply with the CE certification requirements.

The design and specifications are subject to change without prior notice for product improvement. Consult with the sales agency or manufacturer for details.